

**Kaldewei Puro Inset Bath with White Multifiller 1700mm x 750mm White**

1771649

**SPECIFICATIONS**

Recommended Use	Domestic, Hotel & Commercial
Material	Steel Enamel
Colour	White
Capacity	137 ltr
Weight	50 kg
Overflow Configuration	Overflow
Mounting	Inset
Plug & Waste Size	40mm
Plug & Waste	Included

**WARRANTY**

Warranty - Domestic Use	30 Years
Parts Replacement Only	12 Months

*Please refer to Warranty Page for full Terms and Conditions*

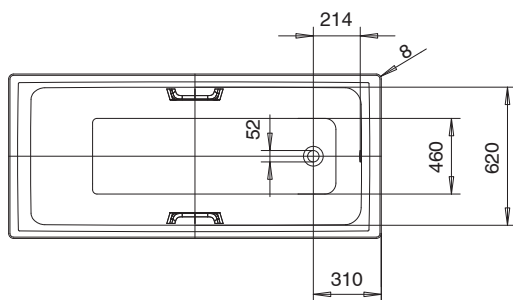
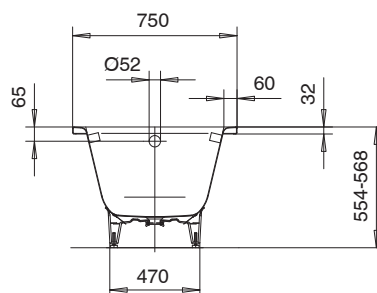
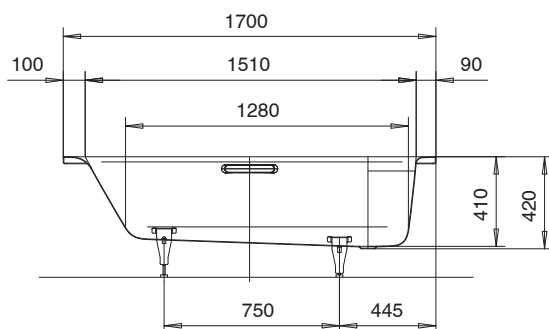

Dimensions are nominal measurements only.

**CLEANING RECOMMENDATIONS:**

We recommend the use of soapy water or approved cleaners. This product should not be cleaned with abrasive materials. Damage caused by any improper treatment is not covered by the product warranty. Refer to Warranty Conditions

Disclaimer: Products in this specification manual must by regulation be installed by licensed and registered trade people. The manufacturer/distributor reserves the right to vary specifications or delete models from their range without prior notification. Dimensions are nominal measurements only. Dimensions and set-outs listed are correct at time of publication however the manufacturer/distributor takes no responsibility for printing errors.

Published 01/12/2022

To see the complete Kaldewei range go to [www.reece.com.au](http://www.reece.com.au)

