

FRAMED DOUBLE PANEL

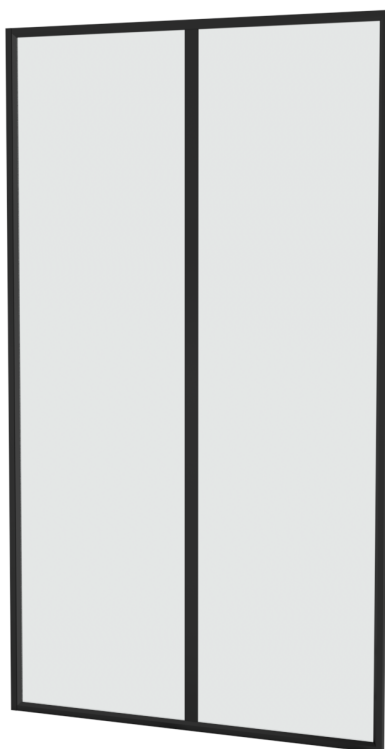

To see the complete CUSTOM GLASS range go to
www.reece.com.au/bathrooms

SPECIFICATIONS

Recommended use	Domestic, Hotel, and Commercial
Material	Screen-6mm Low Iron Toughened Glass. Australian Safety Standards Compliant.
Floor Suitability	Tiled Floor Installation
Frame & Support Rail Colour	Black
Optional Extras	1789912 - Installation Charge 1791295 - Shower Screen Removal

SIZE VARIATIONS

Code	SIZE	HEIGHT
1789895	1000	2000
1789896	1100	2000
1789897	1200	2000

CLEANING RECOMMENDATIONS

We recommend the use of soapy water or approved cleaners.

This product should not be cleaned with abrasive materials.

Damage caused by any improper treatment is not covered by the product warranty - refer to Warranty Conditions.

Please refer to detailed Cleaning Instructions on page 11.

FRAMED DOUBLE PANEL

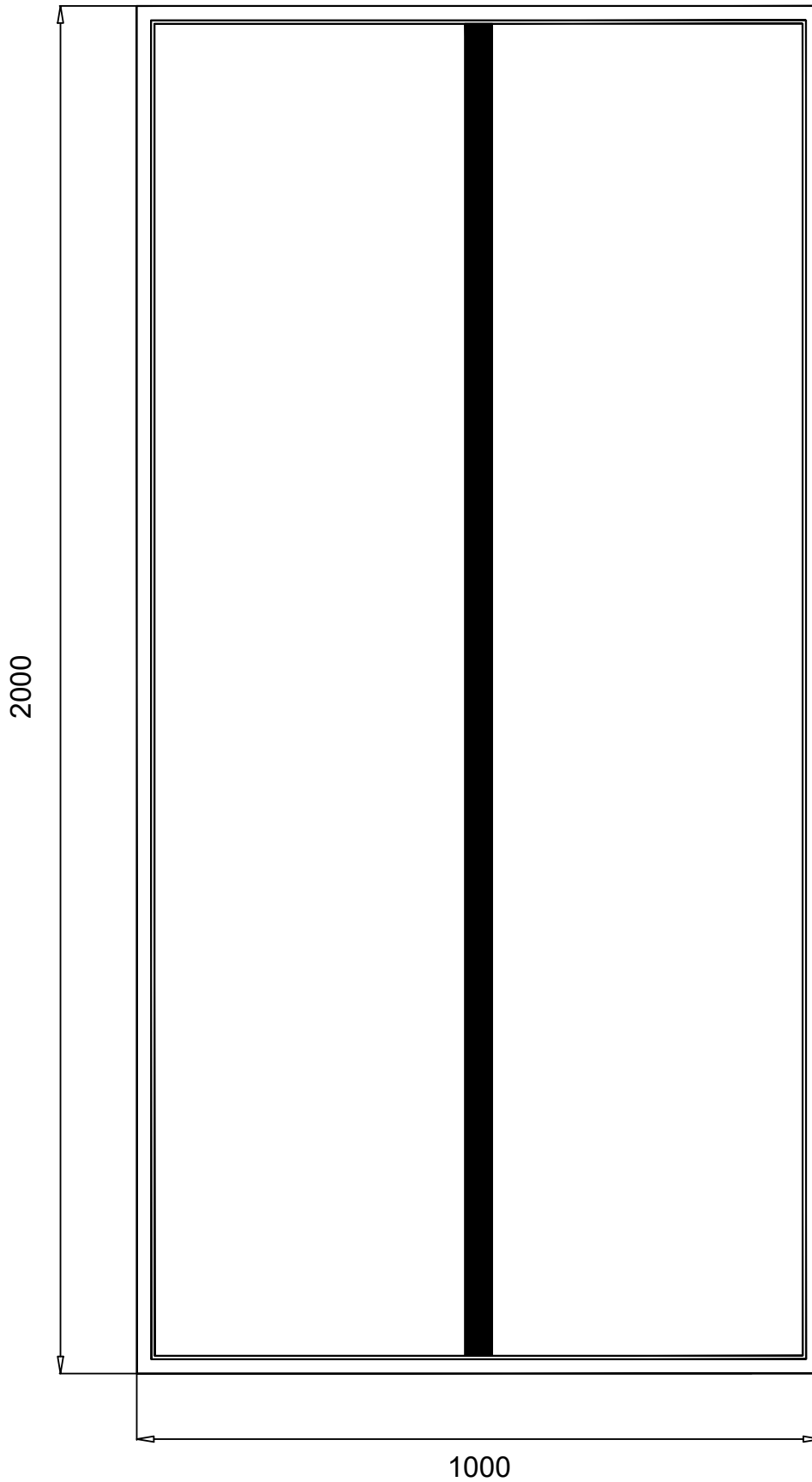

Dimensions are nominal measurements only.
Dimensions are shown in Millimetres

FRAMED DOUBLE PANEL

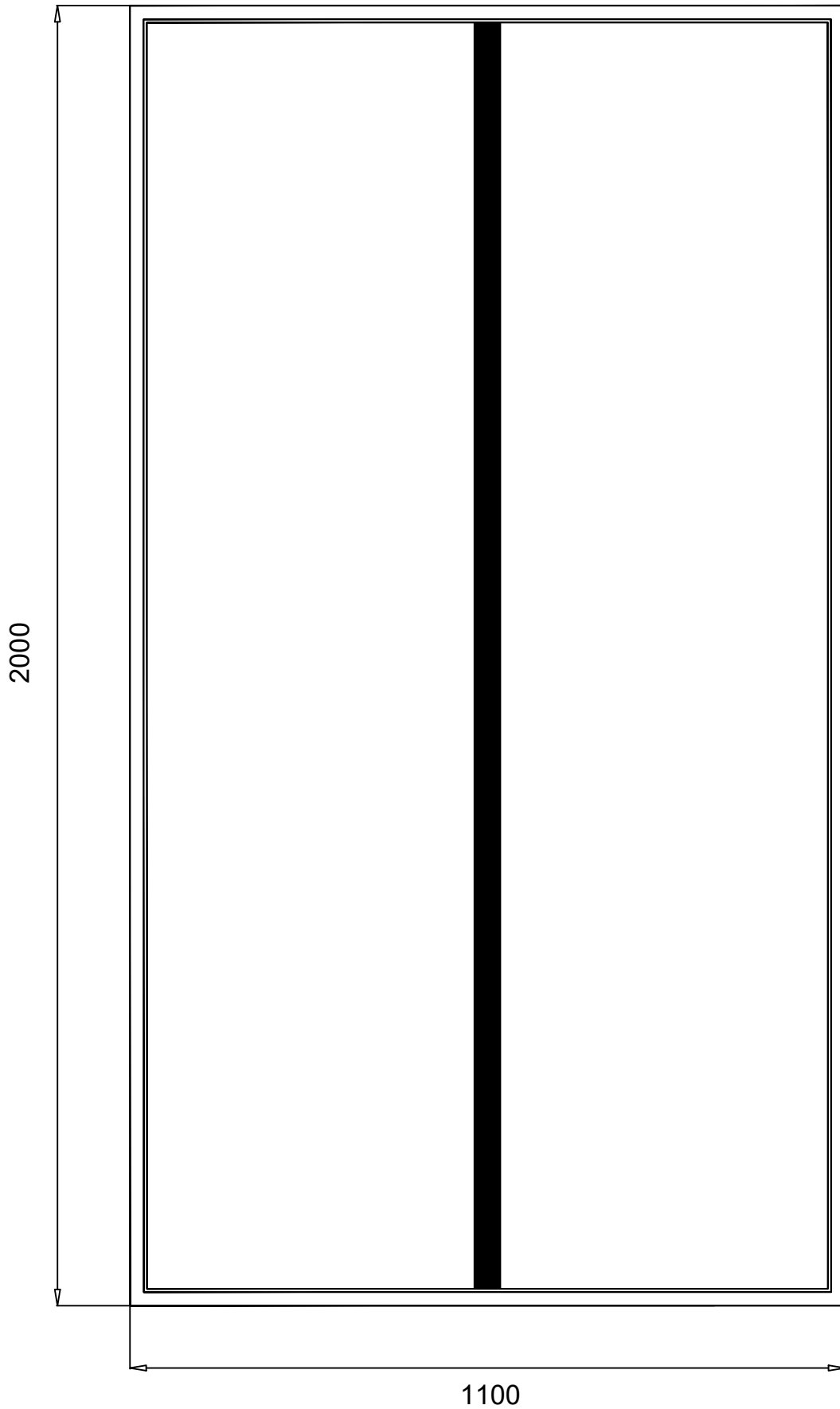

FRAMED DOUBLE PANEL

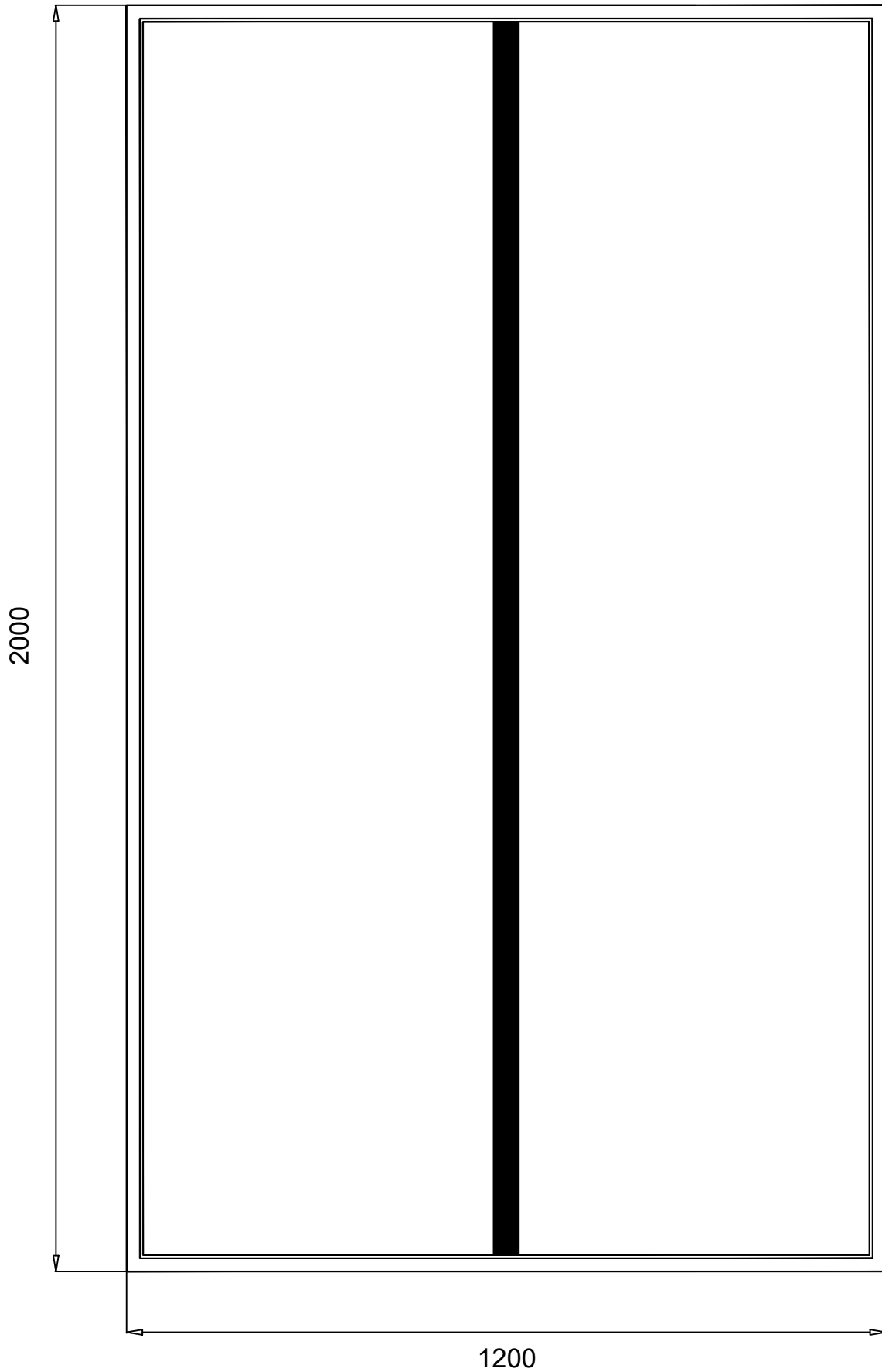

FRAMED DOUBLE PANEL

Important Pre-Installation Information

- Please read this entire instruction book before commencing installation.
- A licensed tradesman must be used for the installation.
- Please ensure all tiles are grouted and silicone work is completed before attempting to install this product

Maintenance

If water alone is not enough to clean the glass, Custom Glass recommends the use of mild detergent solutions only.

Tools Required



Silicone Sealant



Drill



Level



Rubber Mallet



Pencil

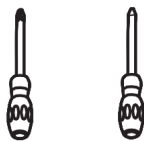

Phillips Screwdriver



Tape Measure



Cutting Pliers



Utility Knife



6mm (1/4") and
3mm (1/8") Drill Bits



Safety Goggles





Gloves

* Use the correct type of drill bit for the material being drilled, with 6mm required for anchor fixing and 3mm used for screwing directly into the wall studs.

** As with all toughened glass, take care while handling and wear safety goggles and gloves for personal protection.

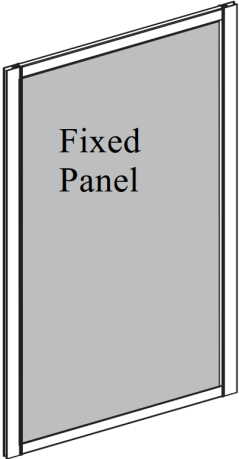
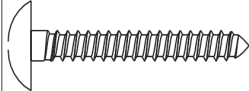
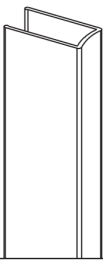
FRAMED DOUBLE PANEL
COMPONENTS
Fixed Panel Items

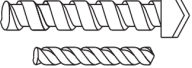
NO.	Designation	Pieces	NO.	Designation	Pieces
1	 Fixed Panel	X1	4	 ST4X35	X4
2	 Wall Channel	X1	6	 ST4X10	X4
3	 Fixings	$\phi 8$ X4	Not Supplied  $\phi 8$ $\phi 3.2$		

FRAMED DOUBLE PANEL

FIXED PANEL INSTRUCTIONS

1.

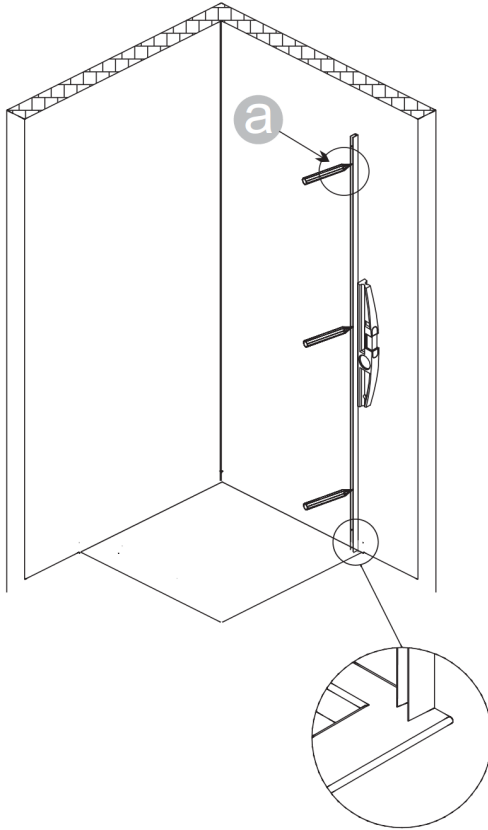

Wall Channel must be level

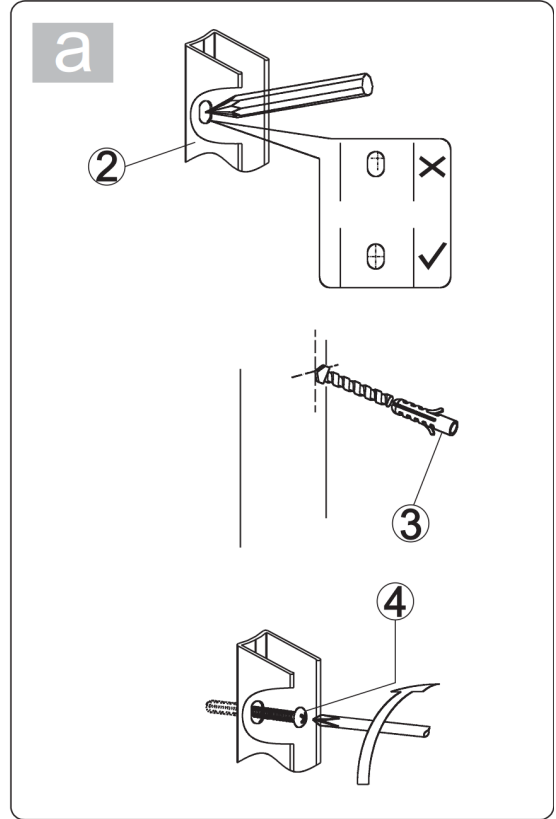

2.

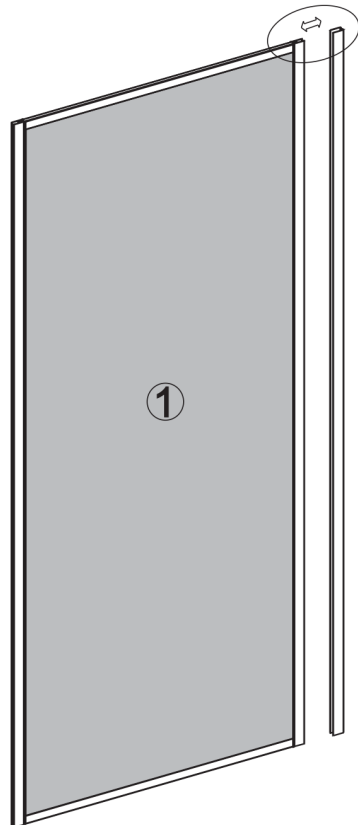

Insert Panel into the wall Channel

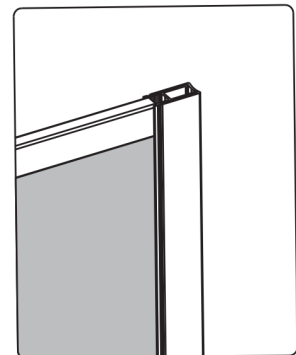

FRAMED DOUBLE PANEL

INSTALLATION INSTRUCTIONS

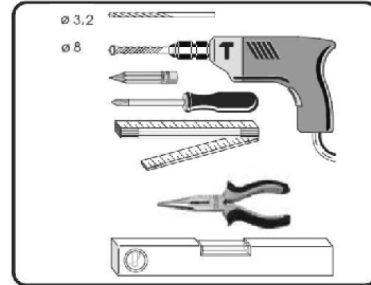
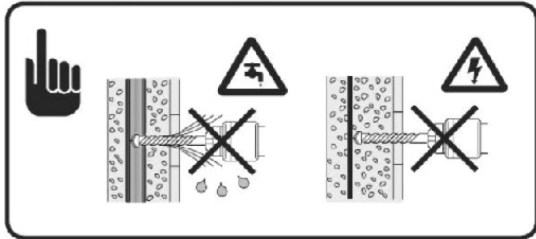

3.

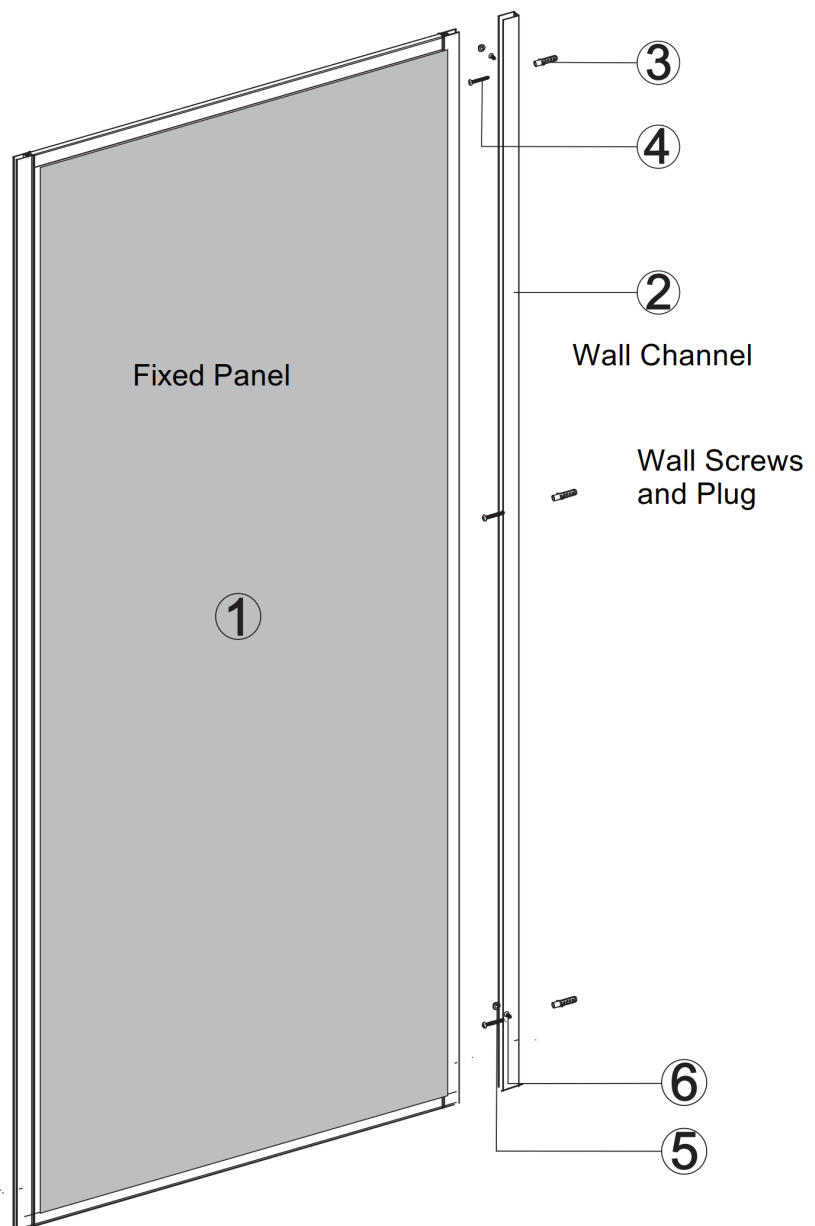

FRAMED DOUBLE PANEL

4.

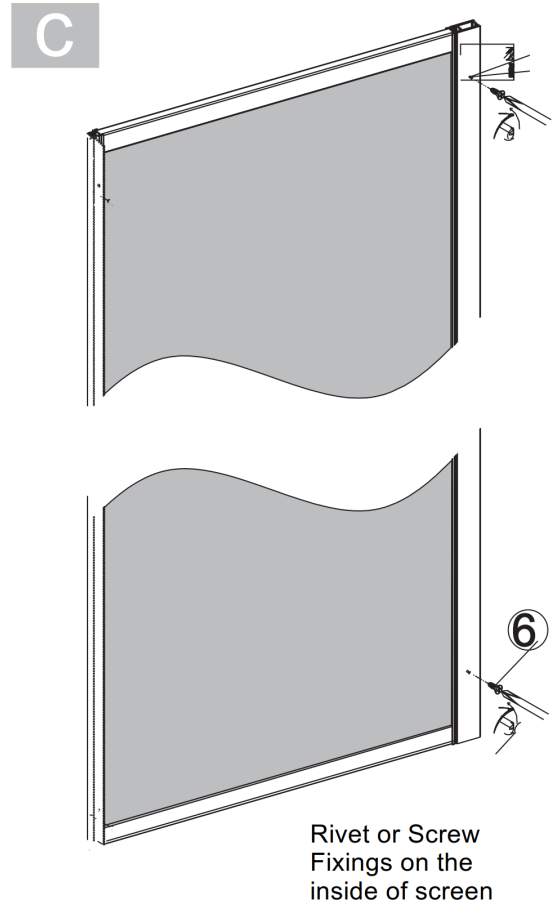
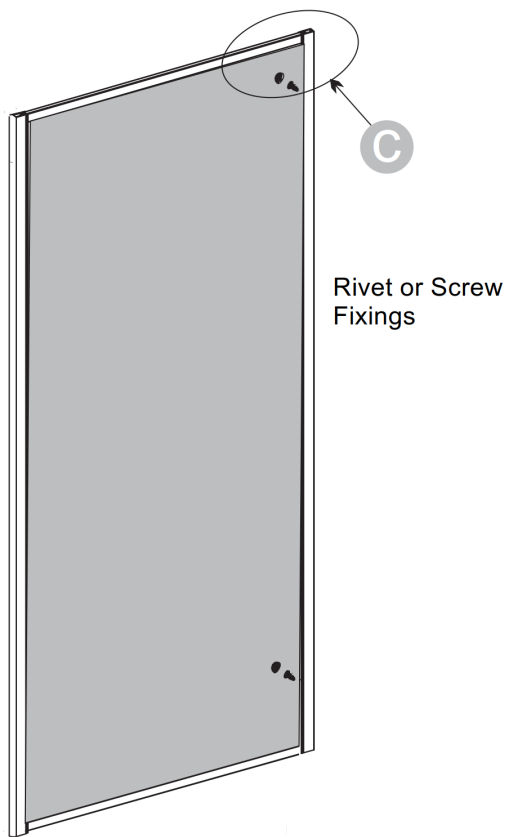

FRAMED DOUBLE PANEL

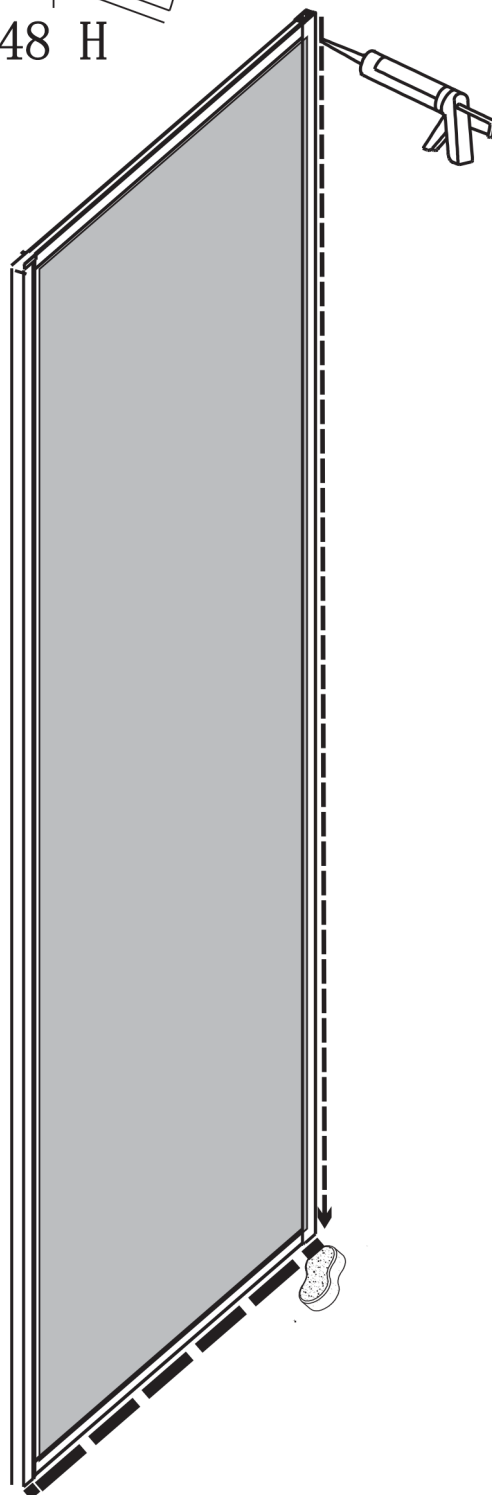

Silicone
Down
both Wall
Channels
inside
and out.
Only seal
the bottom
rails on the
outside



FRAMED DOUBLE PANEL

DETAILED CLEANING INSTRUCTIONS

Easy Clean Treated Glass

After showering we strongly recommend you squeegee the glass to remove water from the surface.

A weekly clean using water and 30% vinegar or a mild detergent is all it takes to remove dirt, soap scum and other contaminants.

Spray the vinegar and water on the glass and wipe with a soft cloth, leave this on the surface for several minutes before rinsing and drying the glass.

Aluminium Frame and Metal Components

The simplest and most preferred method of cleaning your unit is by washing with clean water and drying with a soft cloth.

Do not use Abrasive powders, steel and Teflon pads or dirty and gritty rags. The anodised coating on the Aluminium is one of the hardest substances known, however, it will be damaged by strong acidic or alkaline solutions. These solutions may dull and discolour the finish.

The most reliable preventative measure to preserve your screen is to wipe the surface dry with a soft cloth after each use.