

Posh Domaine Inset Bath 1420 x 800 x 500mm White

INSTALLATION INSTRUCTION:

1. This bath is not self supporting and does require a support at the base via masonry, steel, timber. It is important that the full rim of the bath rests on a support wall constructed from wood, masonry or steel.
2. Place bath in position and connect waste. Fill bath and then release, checking seals for leaks and that the bath drains successfully.
3. Apply flexible sealant to the exposed edges.

NOTE:

Please check surface thoroughly before installing. Installation of the bath will be taken as acceptance of the product. It is important to install the product in accordance with the installation instructions below.

This Bath requires support at the base via masonry, steel, timber or a bed of sand/cement slurry.

CLEANING RECOMMENDATIONS:

We recommend the use of soapy water or approved cleaners. This product should not be cleaned with abrasive materials. Damage caused by any improper treatment is not covered by the product warranty. Refer to Warranty Conditions

Diagram A

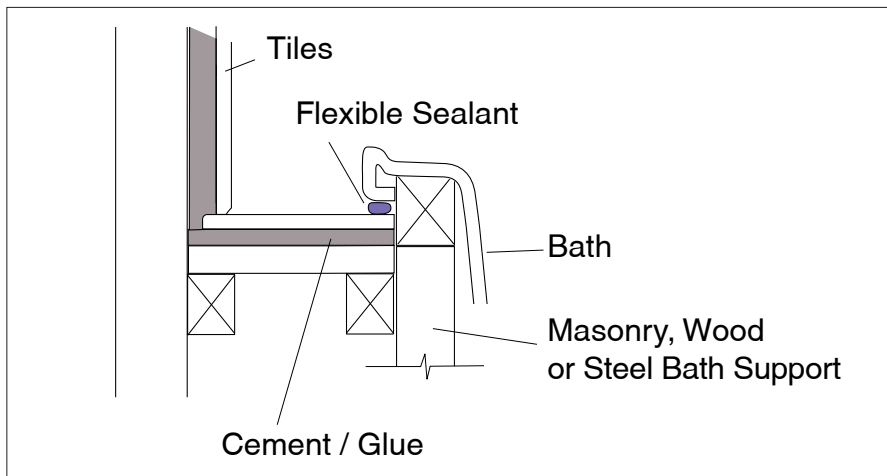
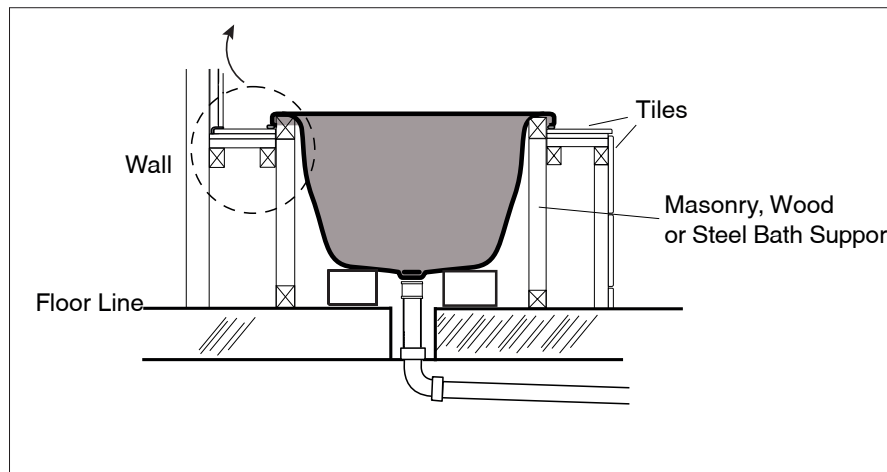

Diagram B



Plumbers, please ensure a copy of the Installation Instructions are left with the end user for future reference