

ISSY

Halo III Vanity Unit



SPECIFICATIONS

Recommended Use	Domestic, Hotel & Commercial
Vanity Cabinet Material	American Oak veneer (19mm)
Vanity Frame Material	2 Pack Polyurethane on High Moisture Resistant MDF
Door Design	Touch release/ Soft close drawer/s
Benchtop Material	Corian (12mm)
Handles Material	150Dia Corian or Marble
Colour Variations (Prices may vary)	Please refer to the Colour, Finish and Material Variations Document on the Website for more information.
Fixing	Bolted / Screwed to Wall by a Licensed Trades Person (not included)
Basin	Sold Separately, refer to Brochure
Tapware	Sold Separately. Compatible with Wall mounted tapware
Features	Internal Fixed Shelf



To see the complete Issy range go to www.reece.com.au/bathrooms

STANDARD SIZES	H3-VU500	H3-VU600	H3-VU1000	H3-VU1200	H3-VU1500	H3-VU1800
Width (mm)	500	600	1000	1200	1500	1800
Depth (mm)	450	450	450	450	450	450
Height (mm)	450	450	450	450	450	450
Number of Drawers	1	1	2	2	3	3
Basin Options	1	1	1	1	1-2	1-2

CUSTOM SIZES	H3-VU501-600	H3-VU601-800	H3-VU801-1100	H3-VU1101-1300	H3-VU1301-1600	H3-VU1601-1800	H3-VU1801-2000
Width (mm)	501-601	601-800	801-1100	1101-1300	1301-1600	1601-1800	1801-2000
Depth (mm)	400-500	400-500	400-500	400-500	400-500	400-500	400-500
Height (mm)	450	450	450	450	450	450	450
Number of Drawers	1	1	2	2	4	4	4
Basin Options	1	1	1	1	1-2	1-2	1-2

Disclaimer: Products in this specification manual must by regulation be installed by licensed and registered trade people. The manufacturer/distributor reserves the right to vary specifications or delete models from their range without prior notification. Dimensions are nominal measurements only. Dimensions and set-outs listed are correct at time of publication however the manufacturer/distributor takes no responsibility for printing errors.

Published 16/02/2024



ISSY

Halo III Vanity Unit

STANDARD SIZES
TOUCH RELEASE DRAWER/S OPENING

500mm

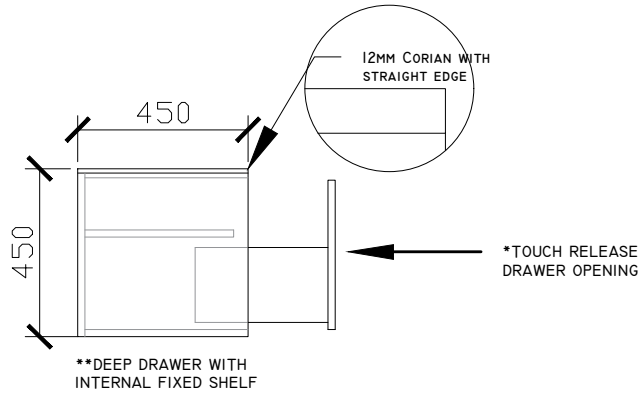
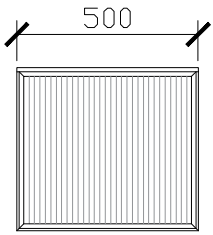

SIDE VIEW for all sizes

600mm

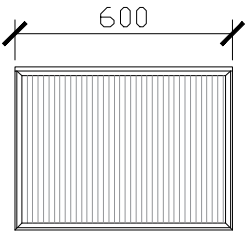

1000mm

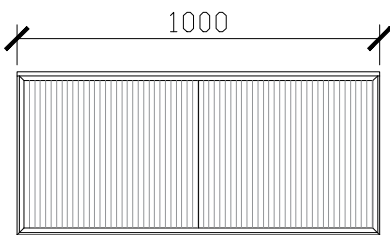

1200mm

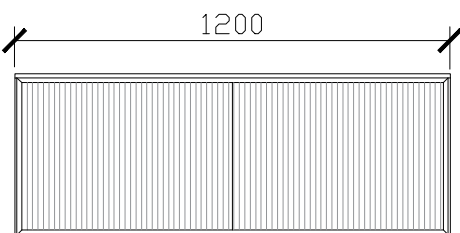

ISSY

Halo III Vanity Unit

STANDARD SIZES
TOUCH RELEASE DRAWER/S OPENING

1500mm

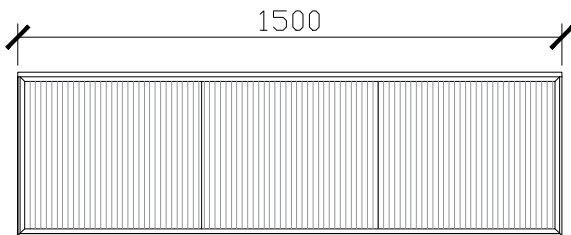

1800mm

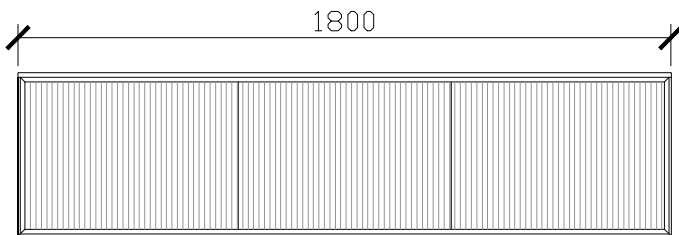

ISSY

Halo III Vanity Unit

CUSTOM SIZES
TOUCH RELEASE DRAWER/S OPENING

501-600mm

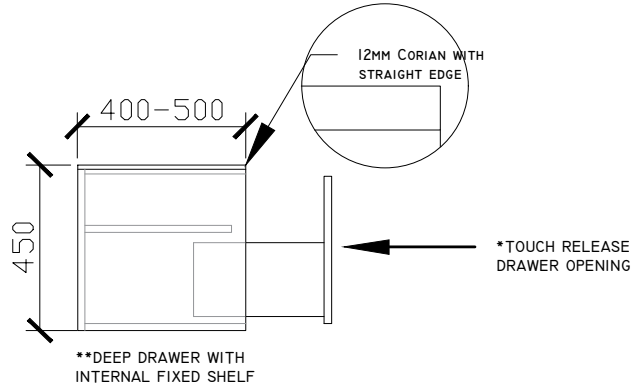
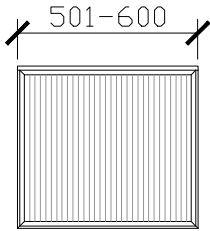

SIDE VIEW for all sizes

601-800mm

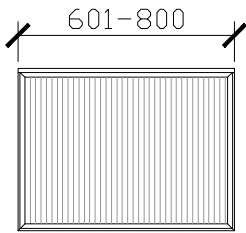

801-1100mm

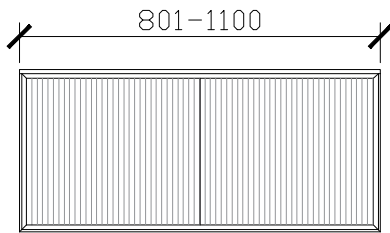

1101-1300mm

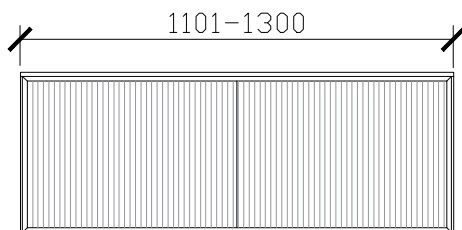

ISSY

Halo III Vanity Unit

CUSTOM SIZES
TOUCH RELEASE DRAWER/S OPENING

1301-1600mm

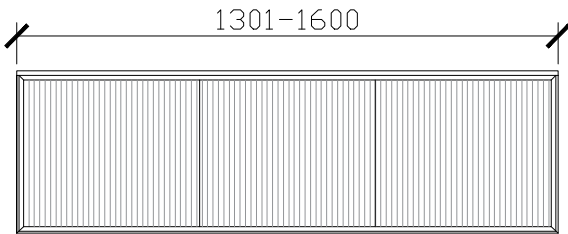

1601-1800mm

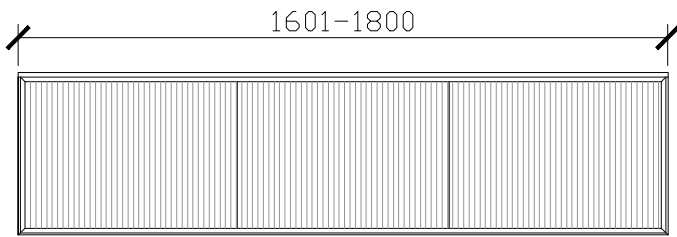

1801-2000mm

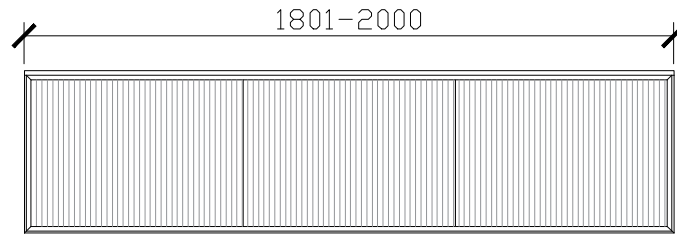

ISSY

Halo III Vanity Unit

STANDARD SIZES
150DIA HANDLE/S OPENING WITH SOFT CLOSE DRAWER/S

500mm

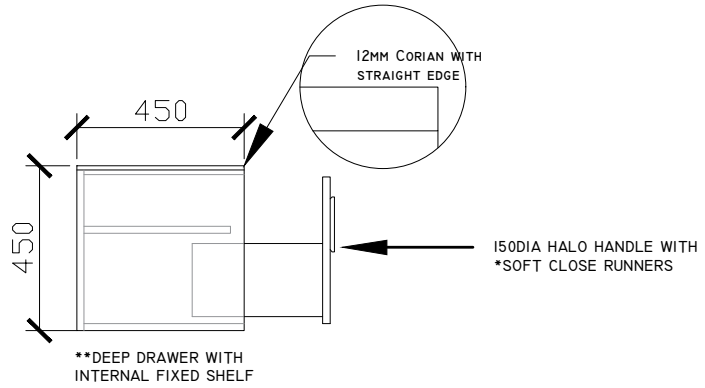
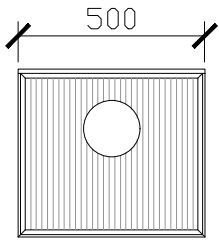

SIDE VIEW for all sizes

600mm

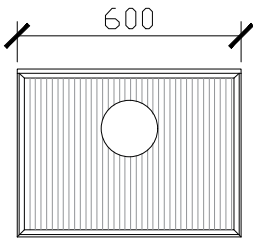

1000mm

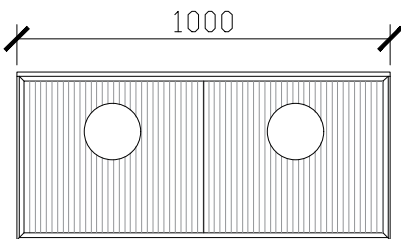

1200mm

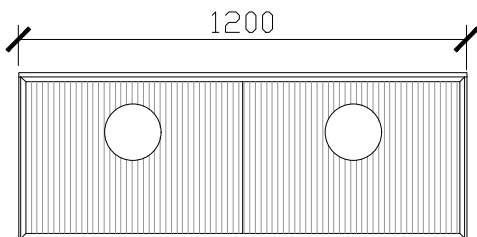

ISSY

Halo III Vanity Unit

STANDARD SIZES
150DIA HANDLE/S OPENING WITH SOFT CLOSE DRAWER/S

1500mm

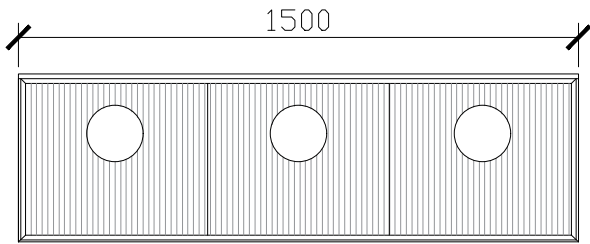

1800mm

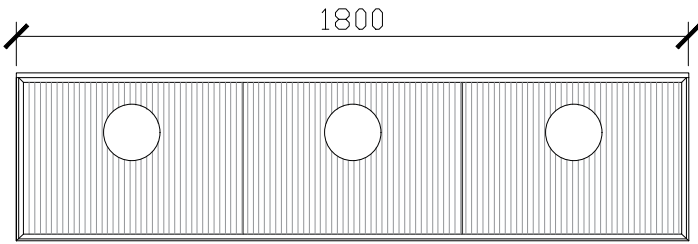

ISSY

Halo III Vanity Unit

CUSTOM SIZES
150DIA HANDLE/S OPENING WITH SOFT CLOSE DRAWERS

501-600mm

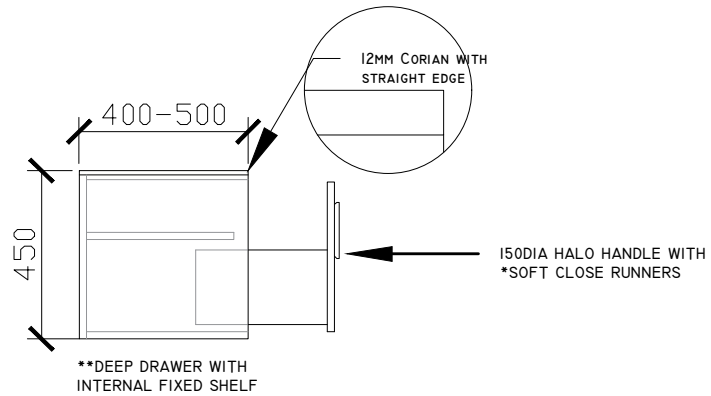
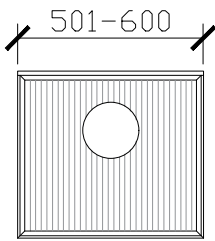

SIDE VIEW for all sizes

601-800mm

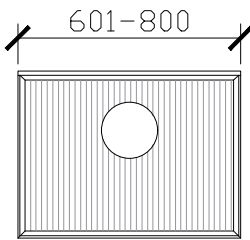

801-1100mm

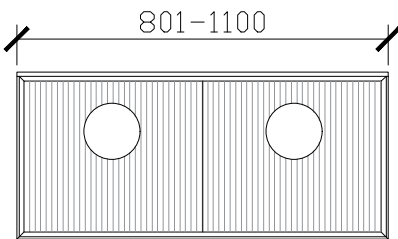

1101-1300mm

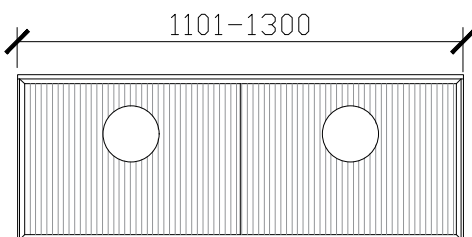

ISSY

Halo III Vanity Unit

CUSTOM SIZES
150DIA HANDLE/S OPENING WITH SOFT CLOSE DRAWERS

1301-1600mm

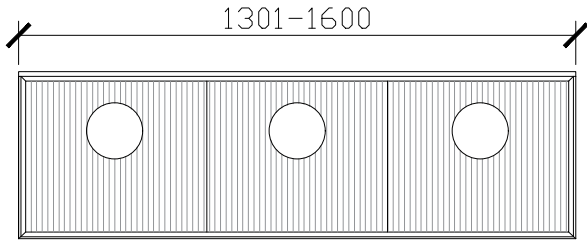

1601-1800mm

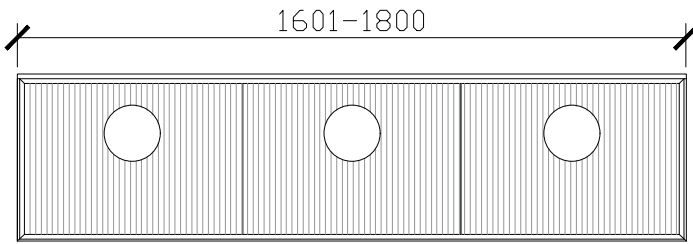

1801-2000mm

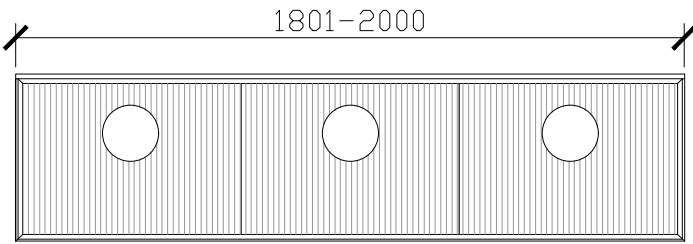

Halo III Vanity Unit

STANDARD - RECOMMENDED FOR COUNTER BASINS
120DIA CORIAN CUTOUT

500 - 600W: CENTRAL ONLY

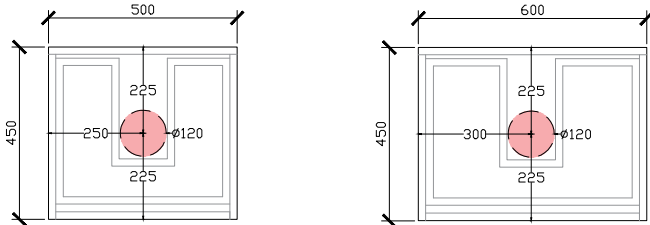

1000W: CENTRE VOID | OFFSET LEFT & RIGHT

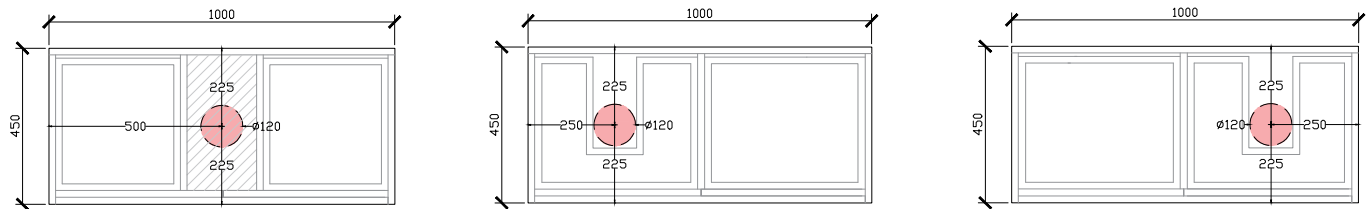

1200W: CENTRE VOID | OFFSET LEFT & RIGHT

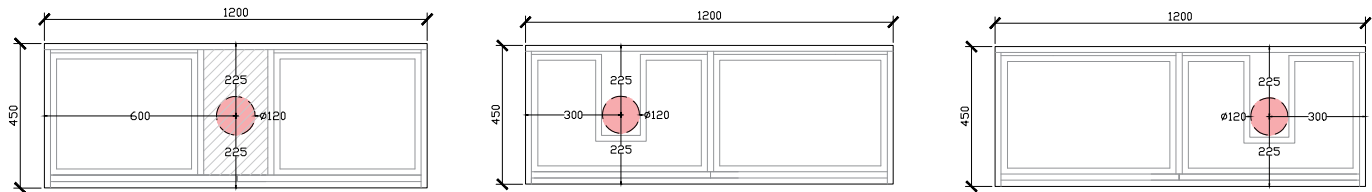

1500W: CENTRAL & DOUBLE BASIN | OFFSET LEFT & RIGHT

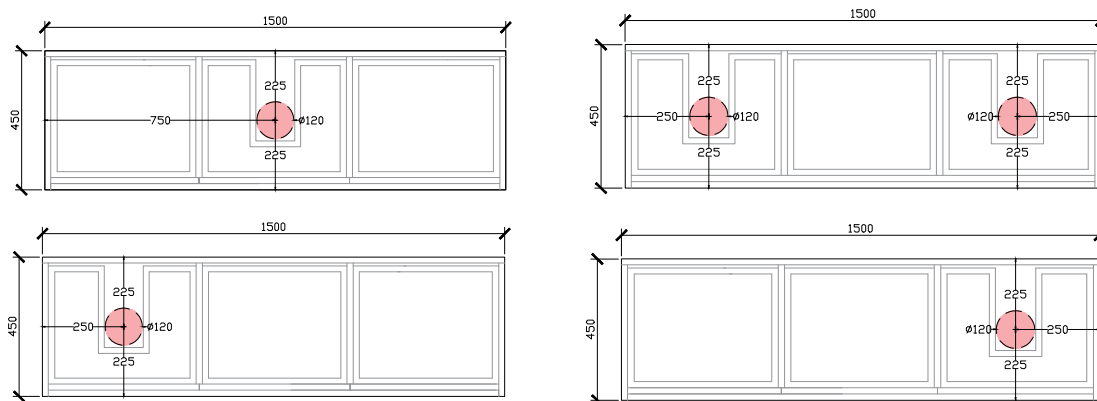

ISSY

Halo III Vanity Unit

STANDARD - RECOMMENDED FOR COUNTER BASINS
120DIA CORIAN CUTOUT

1800W: CENTRAL & DOUBLE BASIN | OFFSET LEFT & RIGHT

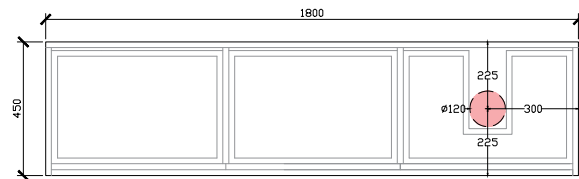
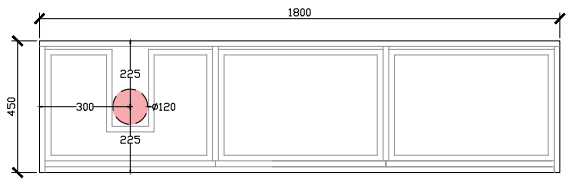
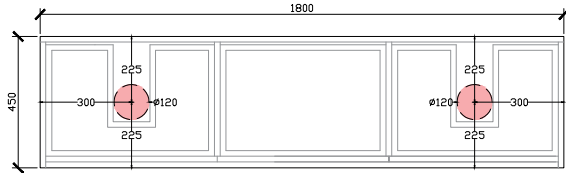
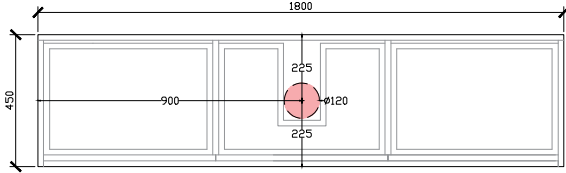

Halo III Vanity Unit

ROCA INSPIRA SOFT SQUARE SEMI-INSET & ROCA INSPIRA ROUND SEMI-INSET
340DIA CORIAN CUTOUT

500 - 600W: CENTRAL ONLY

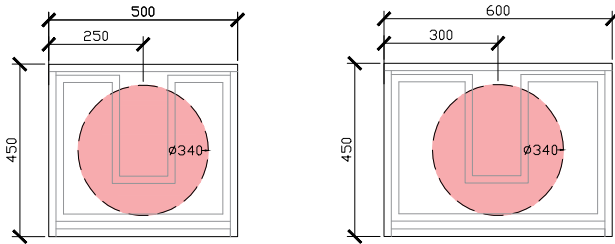

1000W: CENTRE VOID | OFFSET LEFT & RIGHT

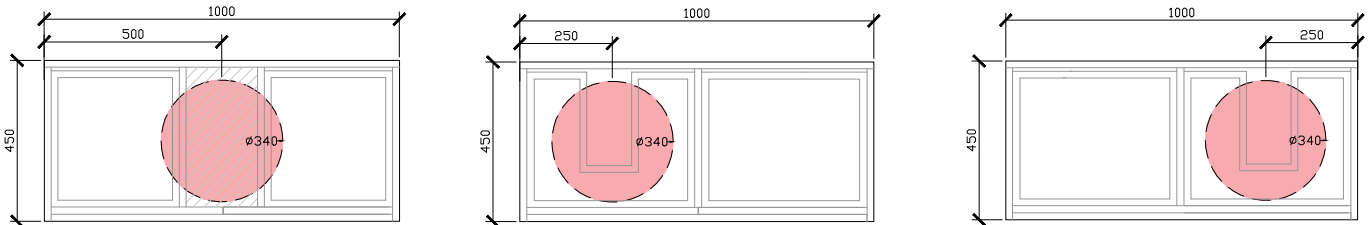

1200W: CENTRE VOID | OFFSET LEFT & RIGHT

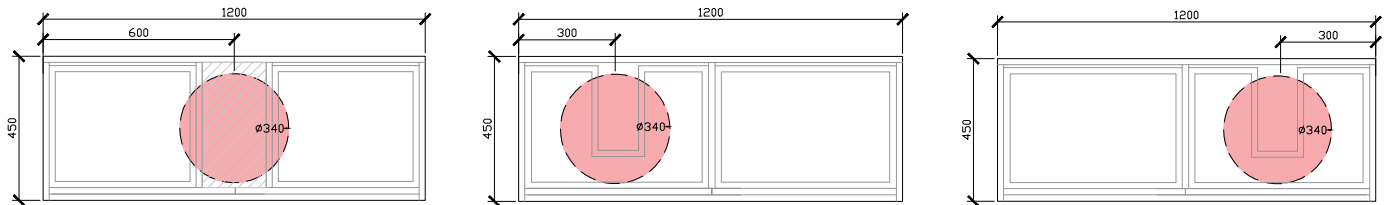

1500W: CENTRAL & DOUBLE BASIN | OFFSET LEFT & RIGHT

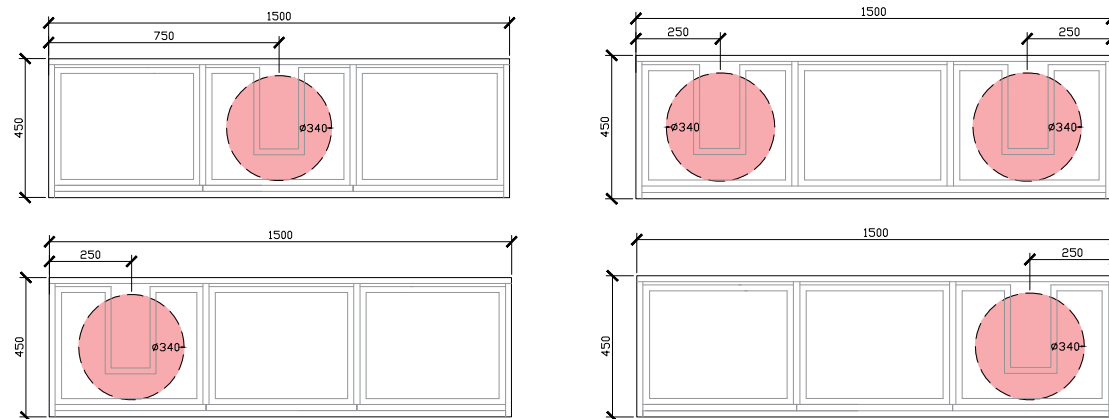

Halo III Vanity Unit

ROCA INSPIRA SOFT SQUARE SEMI-INSET & ROCA INSPIRA ROUND SEMI-INSET
340DIA CORIAN CUTOUT

1800W: CENTRAL & DOUBLE BASIN | OFFSET LEFT & RIGHT

