

Cloud II Semi Inset Wall Hung Vanity Unit

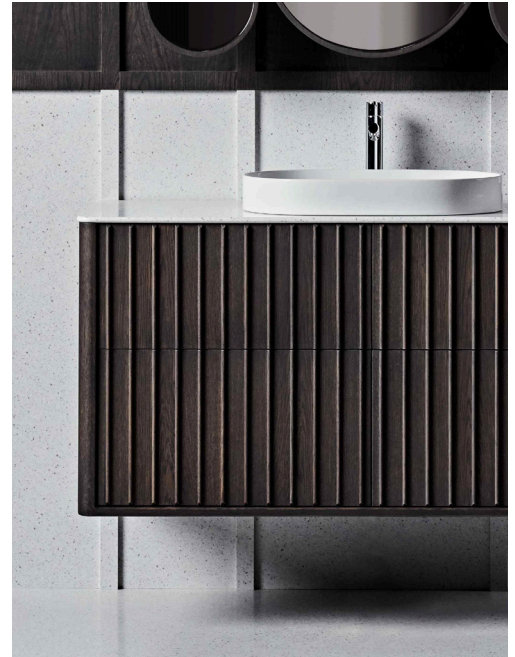

SPECIFICATIONS

Recommended Use	Domestic, Hotel & Commercial
Vanity Cabinet Material	American Oak veneer (19mm)
Vanity Frame Material	2 Pack Polyurethane on High Moisture Resistant MDF
Door Design	Soft close drawer/s
Benchtop Material	Corian (12mm)
Handles Material	American Oak surround with American Oak, Corian or Marble inlay
Colour Variations (Prices may vary)	Please refer to the Colour, Finish and Material Variations Document on the Website for more information.
Fixing	Bolted / Screwed to Wall by a Licensed Trades Person (not included)
Basin	Sold Separately, refer to Brochure
Tapware	Sold Separately. Compatible with Wall mounted tapware
Features	Double drawers

To see the complete Issy range go to www.reece.com.au/bathrooms

STANDARD SIZES	CL2-SEMWH600	CL2-SEMWH1000	CL2-SEMWH1200	CL2-SEMWH1500	CL2-SEMWH1800
Width (mm)	600	1000	1200	1500	1800
Depth (mm)	500	500	500	500	500
Height (mm)	610	610	610	610	610
Number of Drawers	2	4	4	6	6
Basin Options	1	1	1	1-2	1-2

CUSTOM SIZES	CL2-SEMWH601-800	CL2-SEMWH801-1000	CL2-SEMWH1001-1200	CL2-SEMWH1201-1500	CL2-SEMWH1501-1800	CL2-SEMWH1801-2000
Width (mm)	601-800	801-1000	1001-1200	1201-1500	1501-1800	1801-2000
Depth (mm)	400-550	400-550	400-550	400-550	400-550	400-550
Height (mm)	610	610	610	610	610	610
Number of Drawers	2	4	4	4	6	6
Basin Options	1	1	1	1	1-2	1-2

Disclaimer: Products in this specification manual must by regulation be installed by licensed and registered trade people. The manufacturer/distributor reserves the right to vary specifications or delete models from their range without prior notification. Dimensions are nominal measurements only. Dimensions and set-outs listed are correct at time of publication however the manufacturer/distributor takes no responsibility for printing errors.

Published 16/02/2024

Cloud II Semi Inset Wall Hung Vanity Unit

STANDARD SIZES

600mm

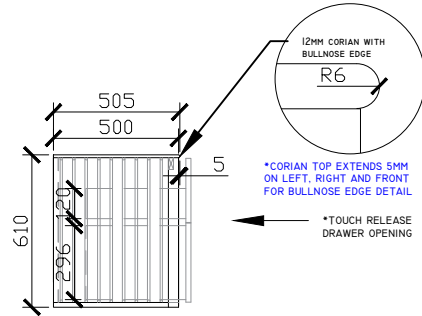
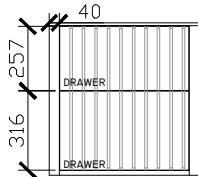
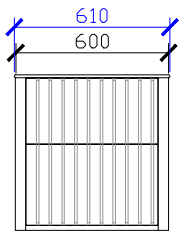

**NOT SUITABLE FOR WALL TO WALL

*PLEASE NOTE: FOR SEMI INSET VANITIES

- DRAWER SIDES START 135MM FROM TOP OF CORIAN
- 120MM DRAWER BOX SIDES

FRONT VIEW for all sizes

SIDE VIEW for all sizes

1000mm

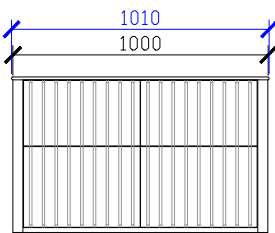

1200mm

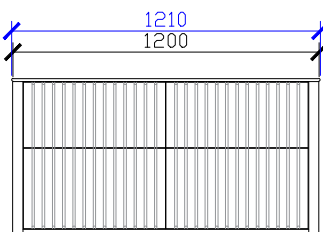

Cloud II Semi Inset Wall Hung Vanity Unit

STANDARD SIZES

1500mm

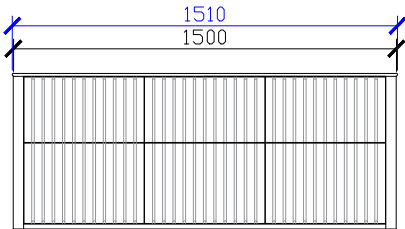

1800mm

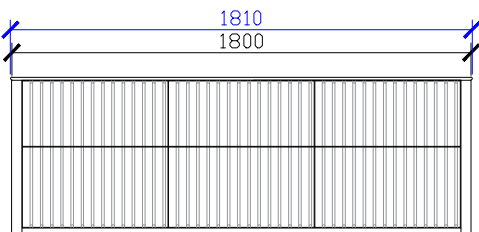

Cloud II Semi Inset Wall Hung Vanity Unit

CUSTOM SIZES

601-800mm

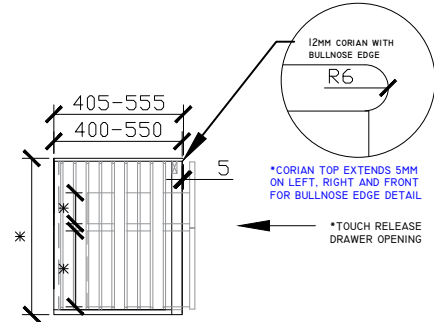
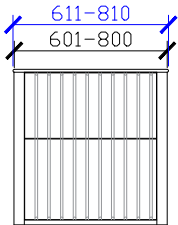

**NOT SUITABLE FOR WALL TO WALL

*PLEASE NOTE: FOR SEMI INSET VANITIES

- DRAWER SIDES START 135MM FROM TOP OF CORIAN
- 120MM DRAWER BOX SIDES

801-1000mm

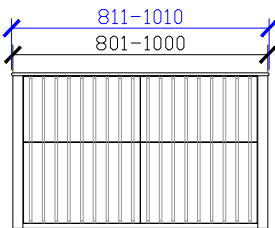

SIDE VIEW for all sizes

1001-1200mm

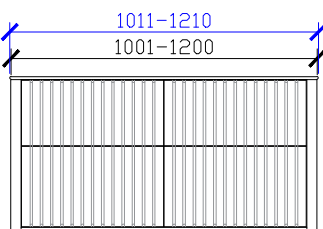

Cloud II Semi Inset Wall Hung Vanity Unit

CUSTOM DEPTH

1201-1500mm

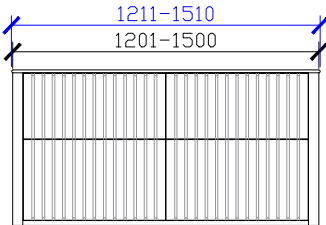

1501-1800mm

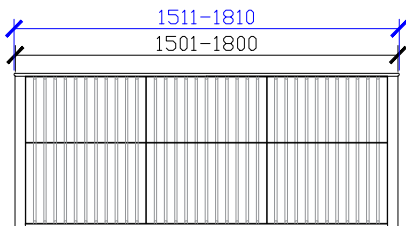

1801-2000mm

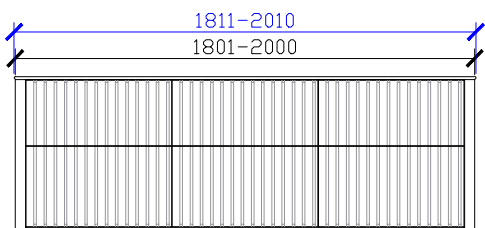

Cloud II Semi Inset Wall Hung Vanity Unit

ROCA INSPIRA SOFT SQUARE SEMI-INSET & ROCA INSPIRA ROUND SEMI-INSET
340DIA CORIAN CUTOUT

600W: CENTRAL ONLY

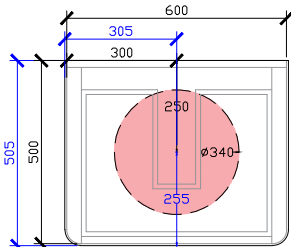

*CORIAN TOP EXTENDS 5MM ON LEFT, RIGHT AND FRONT FOR BULLNOSE EDGE DETAIL

1000W: CENTRE VOID | OFFSET LEFT & RIGHT

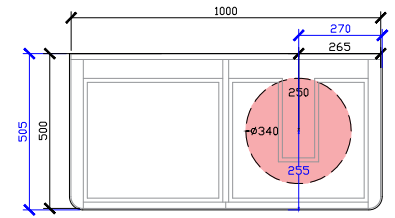
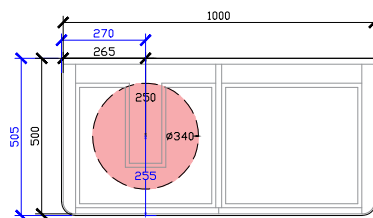
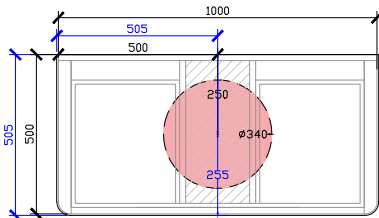

1200W: CENTRE VOID | OFFSET LEFT & RIGHT

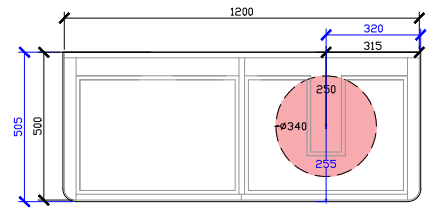
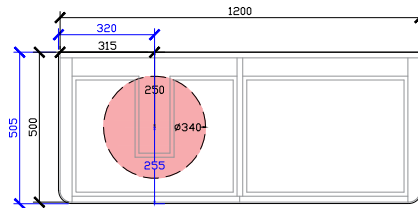
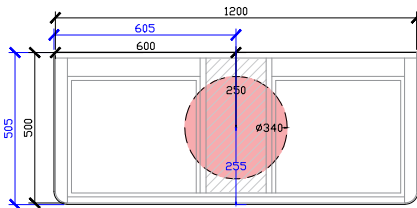

1500W: CENTRAL & DOUBLE BASIN | OFFSET LEFT & RIGHT

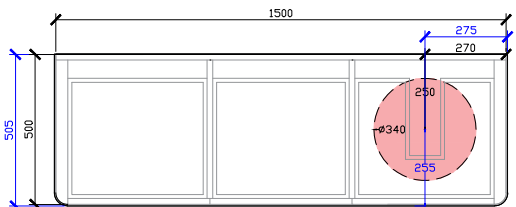
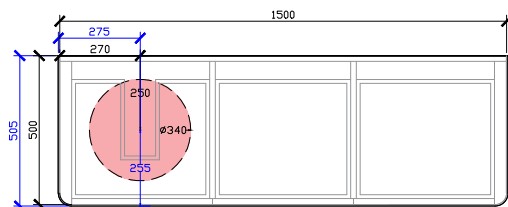
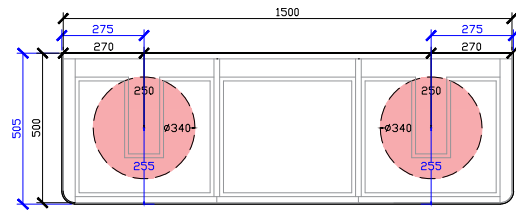
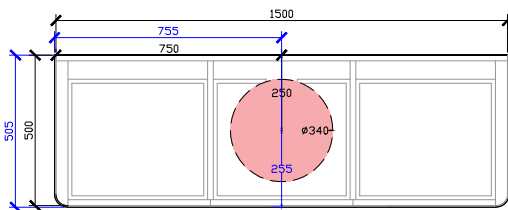

Cloud II Semi Inset Wall Hung Vanity Unit

ROCA INSPIRA SOFT SQUARE SEMI-INSET & ROCA INSPIRA ROUND SEMI-INSET
340DIA CORIAN CUTOUT

1800W: CENTRAL & DOUBLE BASIN | OFFSET LEFT & RIGHT

*CORIAN TOP EXTENDS 5MM ON LEFT, RIGHT AND FRONT FOR BULLNOSE EDGE DETAIL

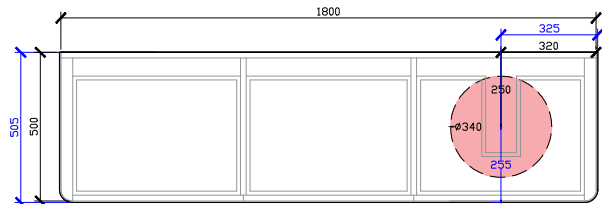
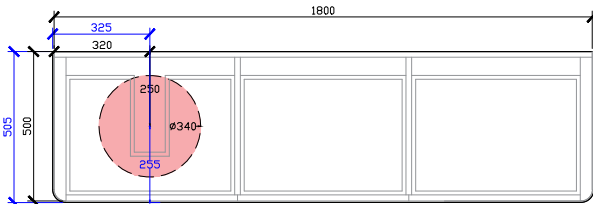
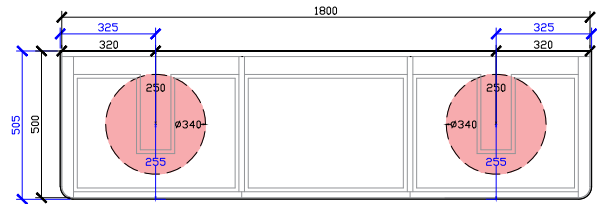
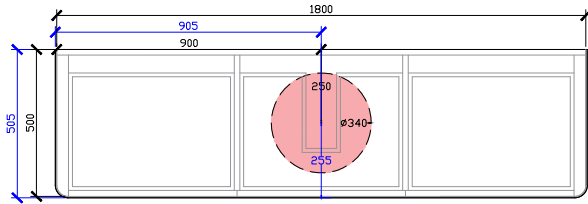

Cloud II Semi Inset Wall Hung Vanity Unit

ROCA INSPIRA SOFT SQUARE SEMI-INSET & ROCA INSPIRA ROUND SEMI-INSET
340DIA CORIAN CUTOUT + TAPHOLE 35DIA

600W: CENTRAL ONLY

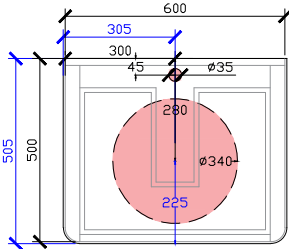

*CORIAN TOP EXTENDS 5MM ON LEFT, RIGHT AND FRONT FOR BULLNOSE EDGE DETAIL

1000W: CENTRE VOID | OFFSET LEFT & RIGHT

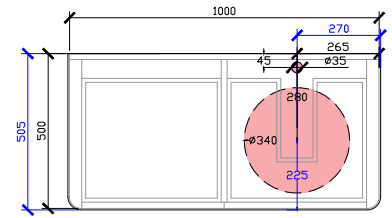
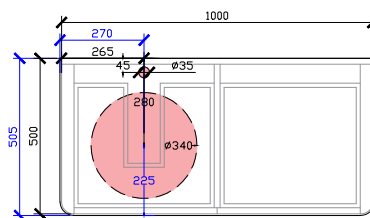
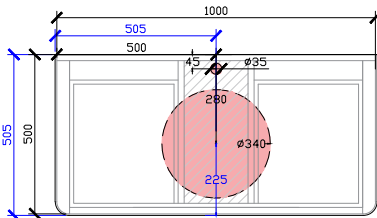

1200W: CENTRE VOID | OFFSET LEFT & RIGHT

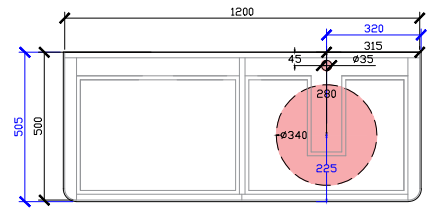
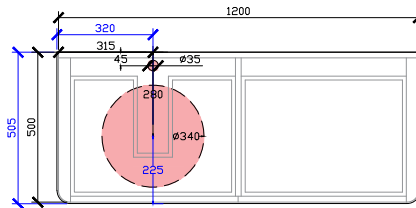
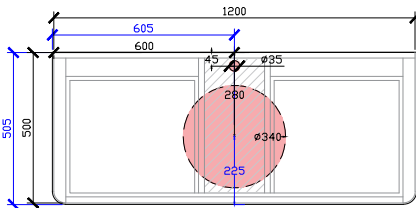

1500W: CENTRAL & DOUBLE BASIN | OFFSET LEFT & RIGHT

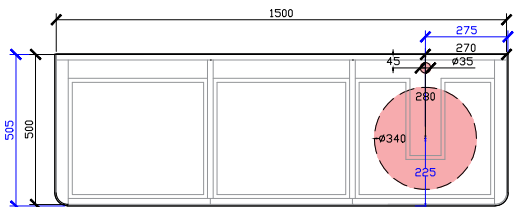
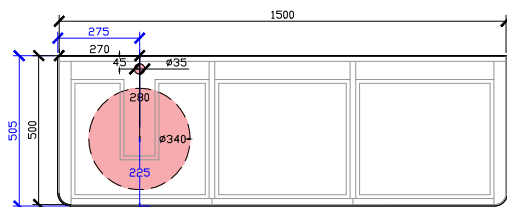
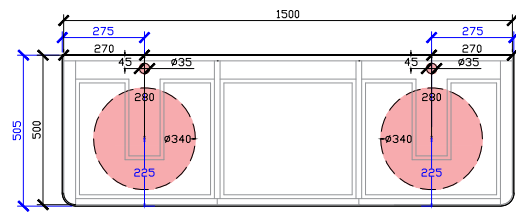
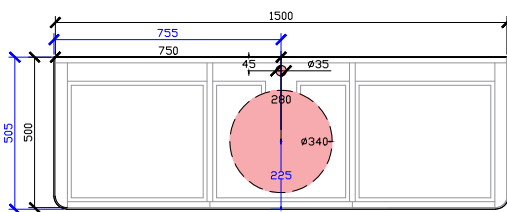

Cloud II Semi Inset Wall Hung Vanity Unit

ROCA INSPIRA SOFT SQUARE SEMI-INSET & ROCA INSPIRA ROUND SEMI-INSET
340DIA CORIAN CUTOUT + TAPHOLE 35DIA

1800W: CENTRAL & DOUBLE BASIN | OFFSET LEFT & RIGHT

*CORIAN TOP EXTENDS 5MM ON LEFT, RIGHT AND FRONT FOR BULLNOSE EDGE DETAIL

