

mizu

Mizu Drift Brass Trapscrew Grate Square/Round 100mm

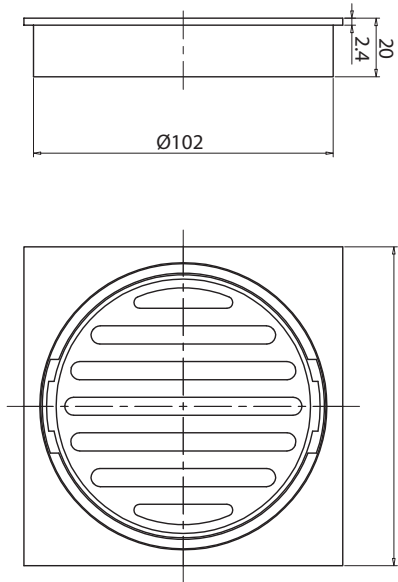

Mizu Drift Brass Trapscrew Grate
Square 100mm

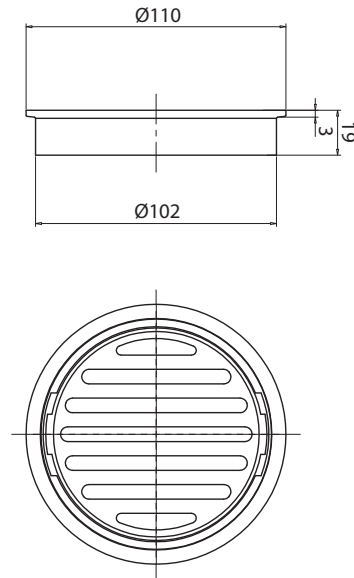

Mizu Drift Brass Trapscrew Grate
Round 100mm

Trap screw grate to be used in conjunction with a puddle flange (leak control flange).

To be installed into a puddle flange as per AS3740 – Waterproofing of domestic wet areas.

Fit leak control flange inlet into the floor, so it can be connected to the outlet S-trap or waste pipe.

Insert the trap screw grate to suit finished floor height (as per the below).



Plumbers, please ensure a copy of the installation instructions is left with the end user for future reference.