



rain2main Automatic Rainwater Controller

VADA - Rain2Main Automatic Rainwater Controller

PRODUCT OVERVIEW / APPLICATION

The Vada Rain2Main is designed to select between stored rainwater (when available) and mains supply water, and send this water to your toilet cistern, washing machine, garden and other non-potable household water applications. It features automatic pump control to minimise the use of electricity while saving water.

When your tank is empty, the Rain2Main seamlessly switches to mains water supply so that there is no interruption of water to your toilet cistern or washing machine.

Do not use the Rain2Main for liquids other than clean water.

TECHNICAL DETAILS

Mains Water supply inlet	1" BSP Female Thread
Pump Connection	1" BSP Female Thread
Water Outlet Connection	1" BSP Female Thread
Protective Rating	IP44
Min Mains Pressure	100 kPa
Max Mains Pressure	1000 kPa
Water Temp Range	1°C - 40°C
Ambient Temp Range	1°C - 40°C
Rated Supply Voltage	230 - 240Vac
Max Electrical Load	10A
Power Consumption (Mains)	1W
Power Consumption (Tank)	18W
Minimum Flow Rate	2 L/min



C of C: 40087 in accordance with WMTS477

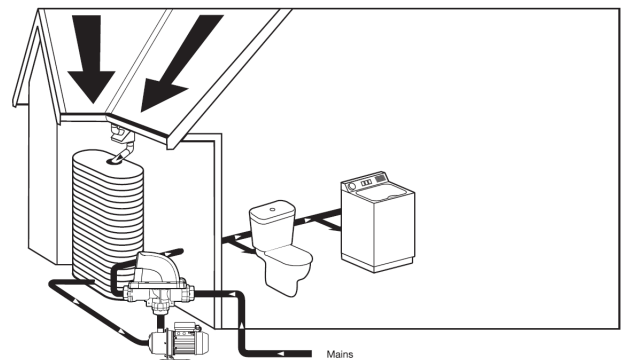

INSTALLATION INSTRUCTIONS



The operator must be provided with this owner's manual. This must be read before installation and followed during installation.



These instructions are a guide only. Users not familiar with the installation and maintenance of electrical and pumping equipment should seek advice from people with experience in pump installation and operation.



Rain2Main is designed to be used with clean water in a residential application. Do not use with alternative fluids, specifically abrasive, corrosive or explosive fluids.



This appliance is not intended for use by persons (incl children) with reduced physical, sensory or mental capabilities, or lack of experience or knowledge, unless have been given supervision or instruction concerning the use of the appliance. Children should be supervised to ensure they do not play with Rain2Main.

WARRANTY & AFTER SALES SERVICE

You have purchased a quality product from Reece Australia. This product is covered by a 24 month warranty. This warranty covers faults in the product construction, material and assembly. Faulty products will be repaired or exchanged free of charge. Faulty items become our property.

This warranty does not include faults caused by

- Unsuitable or improper use
- Incorrect installation
- Normal wear and tear
- Inadequate or complete lack of maintenance
- Chemical, electrochemical or electrical influences

To the maximum extent permitted by law, Reece excludes all warranties other than those set out above. In the event of a warranty claim, we will replace or repair defective products, or pay for the cost of having defective products repaired or replaced, but will not be liable for any injury to any person, damage to any property, any indirect or consequential loss, or in any other respect.

For after sales service, call 1800 080 055.

Disclaimer:

Products in this specification manual must by regulation be installed by licensed and registered trade people. The manufacturer/distributor reserves the right to vary specifications or delete models from their range without prior notification. Dimensions and set-outs listed are correct at time of publication however the manufacturer/distributor takes no responsibility for printing errors.



VADA - Rain2Main Automatic Rainwater Controller

INSTALLATION



Freezing conditions will damage the unit, as water expands as it freezes. Ensure that the Rain2Main is located so that it is not prone to freezing, or ensure that the product is disconnected and dried of water during cold conditions.



Rain2Main is electrically connected. Ensure that it is isolated from electrical supply during installation and any subsequent service work.



Do not install or operate Rain2Main in an explosive environment or near combustible matter.



Brace inlet and outlet connections while fitting Rain2Main. Any movement of connections may disturb internal seals and cause leakage.

PREPARATION FOR INSTALLATION

Read these instructions first. Inspect Rain2Main for shipping damage. Report any damage to your Reece store of purchase.

If the incoming mains pressure to your property is greater than the specified 1000 kPa, please fit a pressure reduction valve of appropriate capacity upstream of Rain2Main. This pressure reduction valve must bring the pressure to below the rated value of 1000 kPa. A recommended pressure is 500-750 kPa. Fitting this type of device to your entire household will extend the life of other appliances such as washing machines, hot water service and dishwashers.

Ensure installation is in accordance with AS/NZS 3500.1 - Plumbing and Drainage - Water Services.

Fittings and Accessories

Ensure that you have all required fittings and accessories prior to installing Rain2Main.

Surface Pumps

For installation we recommend the following items:

- threadseal tape
- 1" BSP male to chosen pipe type connector (x2)

Submersible Pumps

Mounting Rain2Main on a wall is made easy with the optional wall mounting kit. In addition, flexible hose (at least 25mm diameter), barbed hose connectors and hose clamps may also be required.

Protection

Warranty of this Rain2Main is void unless it is operated in accordance with this owner's manual. The pump and Rain2Main should be housed in a weather-proof, well ventilated enclosure, to protect from the weather, flooding, chemicals, dust, vermin, insects, etc.

CAUTION

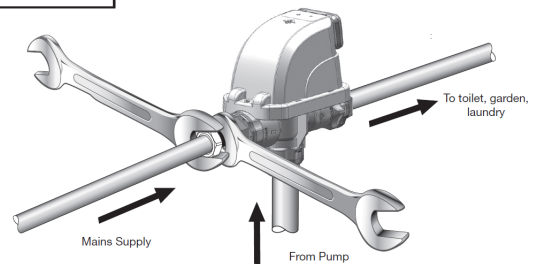

Grip and Brace the connection while fitting pipework

INSTALLATION RECOMMENDATIONS

1. The Vada Rain2Main comes with 2 mesh inline filters. These filters should be correctly inserted on the mains water input and pump input of the Rain2Main.
2. The recommended height of the tank outlet from the base of the tank be set at 100mm.
3. A recommended minimum distance of 100mm of straight pipe at the Rain2Main mains water inlet.
4. Clean water is essential for the reliable operation of your Rain2Main system. We recommend the installation of first flush diverters and leaf guards on your water collection system.

Mounting

The pump and Rain2Main must be mounted on a solid, level, vibration-free surface. The Rain2Main can be mounted in one of two ways:

1. Mount directly to the top of the pump with surface accessory kit.
2. Mount remote from the pump with wall bracket.

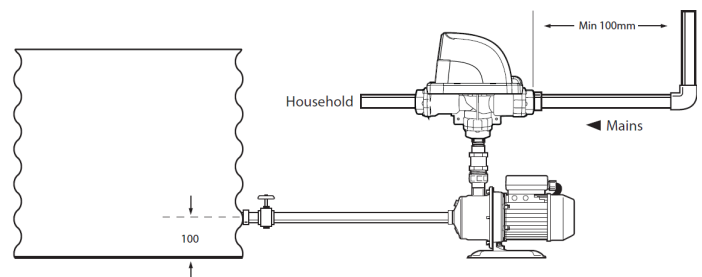

Disclaimer:

Products in this specification manual must by regulation be installed by licensed and registered trade people. The manufacturer/distributor reserves the right to vary specifications or delete models from their range without prior notification. Dimensions and set-outs listed are correct at time of publication however the manufacturer/distributor takes no responsibility for printing errors.



VADA - Rain2Main Automatic Rainwater Controller

INSTALLATION

Connecting the Rain2Main to the Pump Using the Union Kit (Where Supplied)

1. Wrap a sufficient amount of thread seal tape around both ends of the 1" Nipple.
2. Connect one end of the nipple into the pump discharge, threading it until it is watertight. (DO NOT OVERTIGHTEN)
3. Connect the 1" Female end of the complete barrel union onto the protruding end of the 1" Nipple until it is watertight (DO NOT OVERTIGHTEN)
4. Wrap a reasonable amount of thread seal tape around the 1" end of the union nipple. Thread it into the base of the Rain2Main until watertight (DO NOT OVERTIGHTEN). If you are unable to screw the Rain2Main on top due to space limitations, unscrew the barrel union nut releasing the nipple from the union, then thread the nipple into the Rain2Main (Make sure the Union nut remains on the nipple). Rejoin the union to complete the connection.

Mains Inlet Connection

Rain2Main has a 1" BSP Female fitting to connect the incoming mains supply water. This end is marked with an arrow pointing into the unit (showing water flow direction). Brace this fitting to prevent movement while connecting to the mains supply. Any movement of this fitting may disturb internal seals and cause leakage.

Water Outlet Connection

Rain2Main has a 1" BSP Female fitting to connect to household plumbing for uses such as filling toilet cisterns, the washing machine, and garden taps. This end is marked with an arrow pointing out of the unit (showing water flow direction). Brace this fitting to prevent movement while connecting. Any movement of this fitting may disturb internal seals and cause leakage.

Pipe Marking

In accordance with AS/NZS 3500.1:2003, pipes and outlets connected to Rain2Main must be marked as follows:

Outlets that are connected to your Rain2Main must be marked with the wording "RAINWATER". The piping system connected to Rain2Main must be clearly marked at 1m spacings with the wording "RAINWATER"

Rain2Main Electrical Connection

To avoid dangerous or fatal electrical shock, turn OFF power to the Rain2Main before working on any electrical connections. The supply voltage for the Rain2Main must be within the stated parameters.

If the power supply cord or pump interconnection cord is damaged, it must be replaced by a qualified person or return to place of purchase in order to avoid hazard.

Before connecting Rain2Main to an electrical power supply, connect the pump to the Rain2Main using the provided IEC appliance connectors on the end of the interconnection cords. Ensuring there are no traces of water on the connectors, push them firmly into each other to ensure splash proof protection. This connection should only be separated for servicing purposes, and only after the power supply of the Rain2Main is removed either through an isolation switch or by unplugging.

Rain2Main is supplied with a standard Australian 10A plug and cord, and connection to the power supply is a matter of inserting the plug into the suitable socket outlet. If local authorities require the Rain2Main and pump to be hard wired, the electrical connection must be done by a qualified electrician with pump knowledge according to the National Wiring rules (AS/NZS 3000) and/or any local council requirements.

We recommend to connect Rain2Main to a socket outlet protected by a Residual Current Device - RCD (Also known as an Earth Leakage Circuit Breaker – ELCB) with a rated tripping current not exceeding 30mA. Contact a qualified electrician if you cannot verify that the socket outlet is protected by RCD. RCD tripping indicates an electrical problem. If the RCD trips and will not reset have a qualified electrician inspect and repair electrical system.

Do not apply power to the system until the pump has been primed and the water level in the tank is above pump suction inlet. Refer to pump manual for further installation details.

Disclaimer:

Products in this specification manual must by regulation be installed by licensed and registered trade people. The manufacturer/distributor reserves the right to vary specifications or delete models from their range without prior notification. Dimensions and set-outs listed are correct at time of publication however the manufacturer/distributor takes no responsibility for printing errors.



VADA - Rain2Main Automatic Rainwater Controller

Operation

Commissioning

Put a small amount of water in the tank (just above the level of the pump inlet). Prime the pump if surface mounted. Turn power to the rain2main on. Open a tap on the outlet side of the Rain2Main (or have someone flush the toilet). The pump will start. Turn off the tap, and the pump will stop (after a run-on period of 15 seconds). Temporarily close the valve between the tank and pump inlet, or drain the tank to below the pump inlet. This indicates to the Rain2Main that there is no water in the tank, and it will switch to mains supply operation after 5 failed attempts to draw water from the tank. Again, open the tap or flush the toilet. Mains supply water will fill the cistern. Close the tap, open the tank valve and restart the Rain2main. If there are any variations to these outcomes, please see the troubleshooting section.

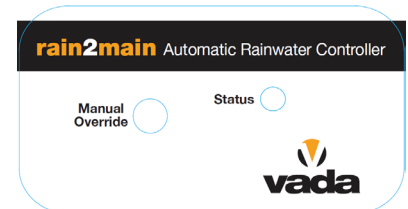

MAINS SUPPLY MODE

Rain2Main has a mechanism to prevent the pump from running with no water. If the tank is empty or there is a blockage or partial blockage somewhere in the system the following process will occur:

1. If Rain2Main is supplying water and is operating normally, it will activate the pump to supply rain water.
2. If the Waterswitch detects no flow of rain water from the tank after approx 30 seconds of pump operation it will shut the pump off and revert to mains water supply.
3. Mains water will then be supplied for approx 30 seconds after which the Waterswitch will revert back to the pump to check for rain water supply.
4. The pump will then operate for approx 20 seconds during which time the Waterswitch will be checking for rain water flow from the pump. During this period the Waterswitch will also allow 2 five second bursts of mains water to flow through the system to keep water flowing to the source of demand.
5. If after this 20 second period the Waterswitch detects no flow of rain water from the pump it will then lock the pump out of operation for a period of 24 hours. During this lock out period only mains water will be supplied.
6. The LED on the Waterswitch will flash red during this period to indicate that the tank water is not available.
7. Automatic Lockout Reset Feature

Event	Reset Time
1st lockout	24 hours
2nd lockout	160 hours (Rain2Main will check for mains water every week following, until water is available in the tank)



This feature can be over ridden by switching the unit off for 10 seconds.

General Operation

Your Rain2Main operates entirely automatically without intervention. If electrical supply is cut in your neighbourhood, Rain2Main will automatically revert to mains supply water, as there is no power to drive the pump. When power resumes, Rain2Main will continue to operate normally.

If town supply water is shut off in your area, Rain2Main might not be able to detect water demand in the household (e.g. if the toilet cistern needs refilling). By pressing the manual override button, you can override normal control and start the pump to supply water out of the rain water tank.

SERVICE AND MAINTENANCE

-  Rain2Main is a warm, dry environment for hibernating insects. These can cause electrical malfunction. Ensure that your property is vermin free.
-  Rain2Main is electrically connected. Ensure that it is isolated from electrical supply during installation and any subsequent service work.
-  Rain2Main should only be serviced by a Pentair Water service agent.

Rain2Main Service

Before removing Rain2Main for service:

1. Switch off power to Rain2Main before proceeding.
2. Close shut off valves at inlet, outlet and water tank gate valve.
3. Carefully release all pressure from the pump and piping system.
4. Never tighten or loosen fittings while the pump is operating.

To reset from 'loss of prime' mode:

- a) Turn off power for 10 seconds
- b) Turn power supply back on
- c) Reprime the pump. Check for blockages in suction line.

Rain2Main should resume normal operation.

Disclaimer:

Products in this specification manual must by regulation be installed by licensed and registered trade people. The manufacturer/distributor reserves the right to vary specifications or delete models from their range without prior notification. Dimensions and set-outs listed are correct at time of publication however the manufacturer/distributor takes no responsibility for printing errors.



VADA - Rain2Main Automatic Rainwater Controller

TROUBLE SHOOTING GUIDE		
Symptom	Cause	Remedy
No water is being delivered from pump	Water tank is empty	Check tank level, wait for rain if empty
	No power at outlet	Check power supply, circuit breakers and plug
	Pump has overheated	Allow pump to cool
	Mesh filter is blocked	Switch power off. Isolate water, remove pump barrel union, inspect/clean/replace filter.
	Pump is worn	Have pump serviced by service agent or other qualified person
No water is being delivered from pump: Rain2Main has gone into 'mains supply' mode	Valve on or between tank & Rain2Main inlet is closed.	Open gate valve and prime pump. Reset Rain2Main
	Pump is not primed	Prime pump and reset Rain2Main
	Mesh filter is blocked	Switch power off. Isolate water, remove pump barrel union, inspect/clean/replace filter.
	Tank is empty	Wait for tank to fill
	Tank was empty and Rain2Main has not yet detected water	Turn off Rain2Main. Wait for 10 seconds. Turn Rain2Main on again.
No water supply at all	Mains water valve is closed	Check mains water isolation valve is open
	Blockage in system	Check mains water and tank water piping for obstructions
	Incoming mains pressure is greater than 1000 kPa	Fit a pressure reduction valve to reduce incoming mains pressure
Poor water pressure through pump	Mesh filter is blocked	Switch power off. Isolate water, remove pump barrel union, inspect/clean/replace filter.
	Worn pump	Have pump serviced by service agent or other qualified person
	Pump is too small for the application	Have local Reece store recommend larger pump
Pump continually runs	Air lock in system	Bleed air from system. Activate appliances / outlets sequentially from the nearest to the furthest outlet. Repeat if necessary. If problem persists, contact your local store.

Disclaimer:

Products in this specification manual must by regulation be installed by licensed and registered trade people. The manufacturer/distributor reserves the right to vary specifications or delete models from their range without prior notification. Dimensions and set-outs listed are correct at time of publication however the manufacturer/distributor takes no responsibility for printing errors.

