

THERMANN™

INSTALLER'S MANUAL

Gas Continuous Flow Water Heaters

Installation Details
Warranty

Models

TH28FNR6N
TH28FNR6L



SBB80TW

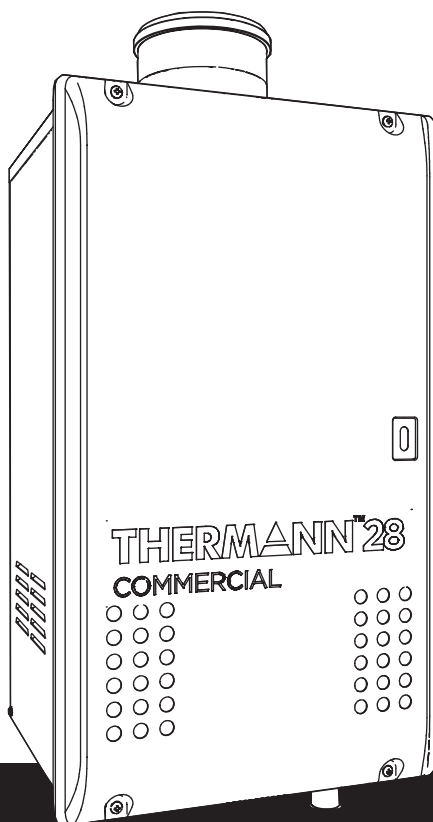

To be installed and serviced only by an authorised person.

This appliance is not suitable for use as a pool heater.

The "authorised installing person" is responsible for:

1. Correct commissioning of this appliance
2. Ensure unit performs to the specification stated on the data label
3. Demonstrate operation of unit to customer before leaving
4. Hand these instructions to customer

This appliance must be installed in accordance with the manufacturer's installation instructions all Local Building, Water and Gas fitting regulations (AS/NZS3500.4, AS/NZS 5601, AS/NZS3000).

This appliance delivers water in excess of 50 Degrees C. Ensure that suitable devices such as Tempering Valves are installed in lines servicing Sanitation areas per AS3500.4.

Failure to install this appliance in accordance with these installation instructions may void warranty.

In the interest of continued product improvement, Reece Manufacturing reserves the right to alter these specifications without notice.

CONTENTS

1. Included Accessories	5
2. Optional Accessories	5
3. Dimensions	6
4. Component Details Example	7
5. Quick Connect Multi System Installation	8
6. Before Installation	9
7. Specifications	10
8. Choosing Installation Site	11
9. Installation Clearances	13
10. Installation	15
11. Flue Piping	16
12. Example of flue installation instruction	20
13. Gas Piping	23
14. Water Piping	24
15. Electrical Wiring	26
16. Remote controller	27
17. Connecting Quick Connect Cord-2	29
18. Maintenance	30
19. Trial Operation	31
WATER QUALITY	33

Installation Manual

Internal Models

TH28FNR6N

TH28FNR6L

Potential dangers from accidents during installation and use are divided into the following three categories. Closely observe these warnings, they are critical to your safety.



DANGER

DANGER indicates an imminently hazardous situation which, if not avoided, will result in death or serious injury.



WARNING

WARNING indicates a potentially hazardous situation which, if not avoided, could result in death or serious injury.



CAUTION

CAUTION indicates a potentially hazardous situation which, if not avoided, may result in minor or moderate injury.

WARNING:



Prohibited



Earth



CAUTION

Requests to Installers

- In order to use the water heater safely, read this installation manual carefully, and follow the installation instructions.
- Failures and damage caused by erroneous work or work not as instructed in this manual are not covered by the warranty.
- Check that the installation was done properly in accordance with this Installation Manual upon completion.
- After completing installation, please either place this Installation Manual in a plastic pouch and attach it to the side of the water heater, or hand it to the customer to retain for future reference.





CAUTION

- The water heater must be commissioned including checking gas supply pressures at maximum demand.
- The operation of the water heater should be explained including normal operation & regular maintenance.



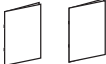



Included Accessories

The following accessories are included with the unit.
Check for any missing items before starting installation.

Part	Shape	Q'ty	Part	Shape	Q'ty
Anchoring Screw		5	Owner's Guide, Installation Manual (this document)		1 each
Drain hose (With clamp)		1	Flue Seal (Ø80, Ø125)		1 each

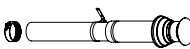
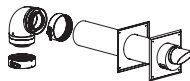
Optional Accessories

The accessories listed below are not included with the units,
but may be necessary for installation.

Part	Shape	Q'ty	Part	Shape	Q'ty
Main Controller (RC-9018C) No. CF-RC-9018C		1	Quick Connect Cord (2m) No. CF-0706891		1
System Controller (SCU-401-12M) for 1-12 units No. CF-SCU40112M		1	Roof Terminal No. CF28C001		1
			Wall Terminal No. CF28C002		1
Extension (With locking band) No. CF28C005 (0.5m. Cut) No. CF28C006 (1m. Non cut)		1	Elbow 90° (With locking band) No. CF28C003		1
Elbow 45° (With locking band) No. CF28C004		1	Wall Bracket No. CF28C007		1

Dimensions

TH28FNR6 series

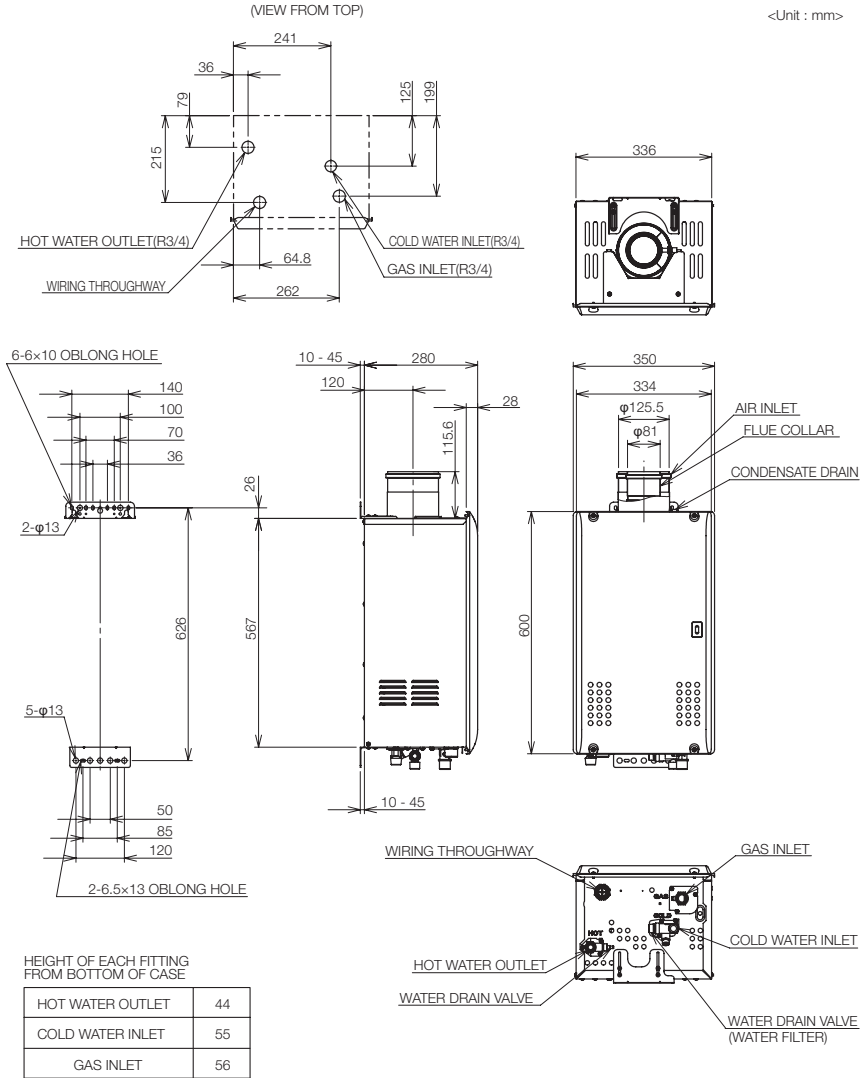

Component Details Example

■ TH28FNR6 series model shown for illustration only

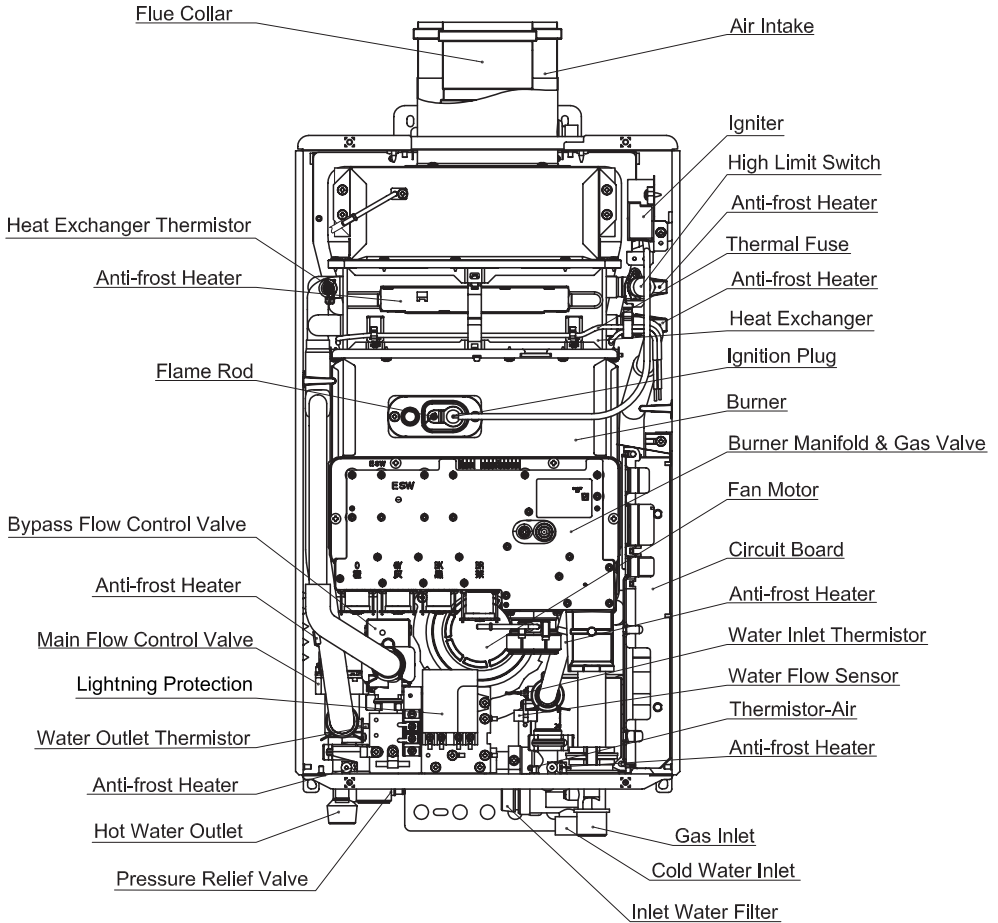

Quick Connect Multi System Installation

- The Quick Connect Multi System allows the installation of two units together utilizing only the Quick Connect Cord.

The Quick Connect Cord is 2m long. Install the units 50 - 457mm apart from each other to ensure the cord will be able to reach between the units. (See Typical Plumbing diagram).
 (If the distance between the two units is too great, not only will the cord not be able to reach, but the water temperature may also become unstable because of the difference in pipe length between the two units).

System Diagram

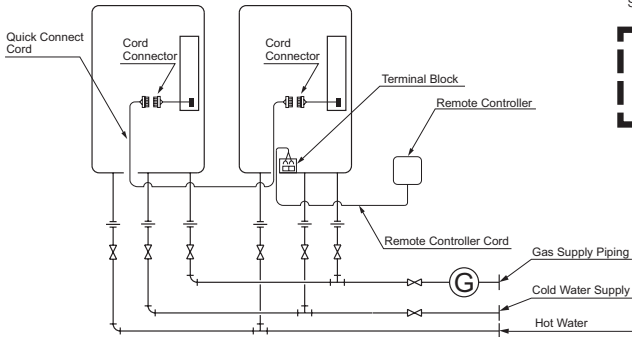

* When connecting two units, use only a single remote controller.

Note: Connect the remote controller to only one of the units.

Typical Plumbing

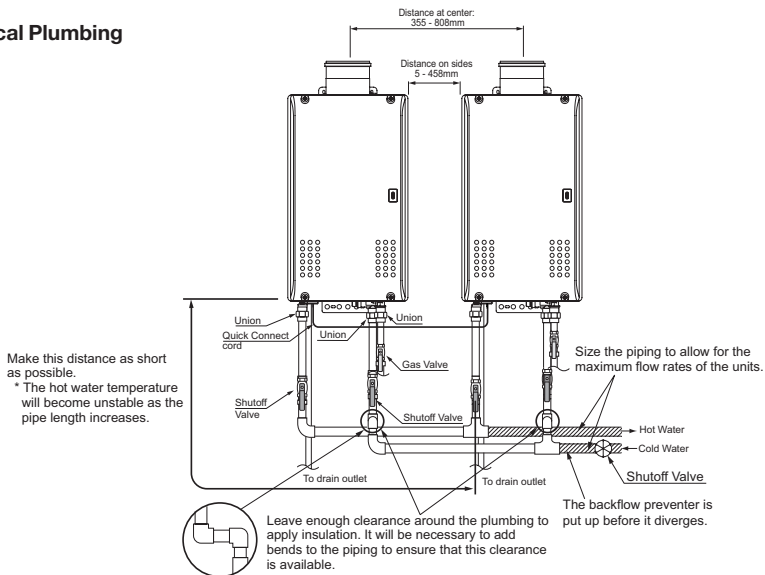

- Insulate the hot water piping to prevent heat loss. Add Insulation materials to the cold water supply piping to prevent heat loss and freezing of pipes when exposed to excessively cold temperatures.

Before Installation

WARNING

Check the Gas

- Check that the data label (Side of casing).
- Check that the gas supply line is sized for TH28FNR6N, TH28FNR6L: 205 MJ/hr, 205 MJ/hr
- DO NOT OPERATE WITH ANY OTHER GAS TYPE.

Check the Power

- The power supply required is 230 - 240VAC, at 50Hz. Using the incorrect voltage may result in fire or electric shock..

Warning labels

- Located on the side of the casing -PLEASE READ THESE LABELS CAREFULLY!

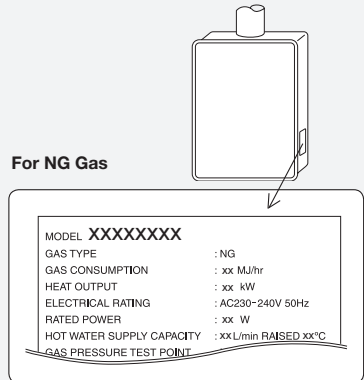

CAUTION

Do Not Use Equipment for Purposes Other Than Those Specified

- Do not use for other than increasing the temperature of the water supply, as unexpected accidents may occur as a result.

Check Water Supply Quality

- If the water supply is hard, acidic or otherwise impure, treat the water with approved methods in order to ensure full warranty coverage. See water quality statement on page 33.

Frost Protection

- When installed, power to the unit must be kept switched on, otherwise the appliance should be drained. This prevents water freezing, and causing damage to the water heater.

Specifications

Model Name		TH28FNR6N	TH28FNR6L
Approval certification number		SAI-400265	
Type	Installation	Indoor, Wall Mounted	
	Air Supply/Exhaust	Power Flue	
Operating Pressure		200 - 1,000 kPa	
Minimum Flow Rate		2.5 L/min.	
Dimensions		600mm (Height) x 350mm (Width) x 280mm (Depth)	
Weight		28 kg	
Water Holding Capacity		1.0 L	
Connection Sizes	Water Inlet	R 3/4 (20mm)	
	Hot Water Outlet	R 3/4 (20mm)	
	Gas Inlet	R 3/4 (20mm)	
Power Supply	Supply	230 - 240 VAC (50Hz)	
	Consumption	NG/ULPG: 75.9 W/75.9 W Freeze Prevention 193W	
Accessories		Anchoring Screws, Drain hose (with clamp), Flue Seal	
Gas	NG	205 MJ/hr	
Consumption	ULPG	205 MJ/hr	
Maximum Hot Water	25°C Rise	28 L/min	

- Specifications may be changed without prior notice.
- The capacity may differ slightly, depending on the water pressure, water supply, piping conditions, and water temperature.

Choosing an Installation Site

- * Locate the appliance in an area where water leakage from the unit or connections will not result in damage to the area adjacent to the appliance or to the lower floors of the structure. When such locations cannot be avoided, it is recommended that a suitable drain pan, adequately drained, be installed under the appliance. The pan must not restrict combustion air flow.
- * As with any water heating appliance, the potential for leakage at some time in the life of the product does exist. The manufacturer will not be responsible for any water damage that may occur.

DANGER

- Locate the flue terminal so that there are no obstacles around the termination and so that exhaust can't accumulate. Do not enclose the termination with corrugated metal or other materials.

WARNING

- Avoid places where fires are common, such as those where petrol, benzene and adhesives are handled, or places in which corrosive gases (ammonia, chlorine, sulfur, ethylene compounds, acids) are present. May result in fire.
- Avoid installation in places where dust or debris will accumulate. Dust may block the air-supply opening, causing the performance of the device fan to drop and incomplete combustion to occur as a result.
- Avoid installation in places where special chemical agents (e.g., hair spray or spray detergent) are used. Ignition failures and malfunction may occur as a result.
- Carbon Monoxide Poisoning Hazard. Do not install this water heater in a mobile home, recreation vehicle or on a boat.
- Leave the proper clearance between the water heater and nearby objects (trees, timber, boxes with flammable materials etc.).



Prohibited

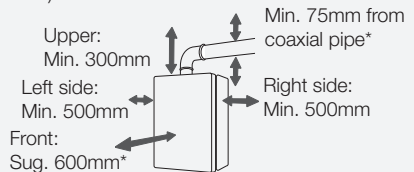
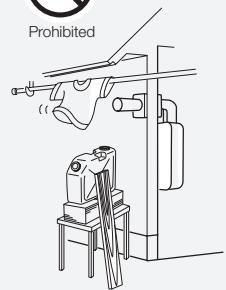

* Indicates suggested clearances for maintenance.

CAUTION

- The water heater is designed for indoor installation only. Never install it outdoors or in a bathroom, it may be damaged or a fire may be caused.
- Consult with the customer concerning the location of installation.
- Install the water heater in an area that allows for the proper clearances to combustible and noncombustible construction. Consult the rating plate on the appliance for proper clearances.
- Do not install the water heater in a place where it may be threatened by falling objects, such as under shelves.
- The water heater must be installed in a place where supply and exhaust pipes can be installed as directed.
- Do not install the water heater where the exhaust will blow on outer walls or material not resistant to heat. Also consider the surrounding trees and animals.

The heat and moisture from the water heater may cause discoloration of walls and resinous materials, or corrosion of aluminum materials.

- Avoid installation above gas ranges or stoves.
- Avoid installation between the kitchen fan and stove. If oily fumes or a large amount of steam are present in the installation location, take measures to prevent the fumes and steam from entering in the equipment.
- Install in a location where the exhaust gas flow will not be affected by fans or range hoods.
- Take care that noise and exhaust gas will not affect neighbors.
- Before installing, make sure that the flue termination will have the proper clearances according to AS/NZS5601, or your local authority.
- On combustible surfaces e.g. weatherboards etc. it is not required to install a fire proof back board.

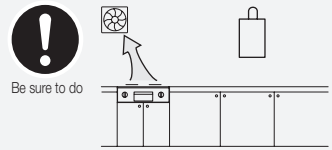
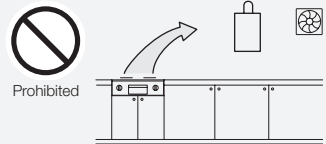
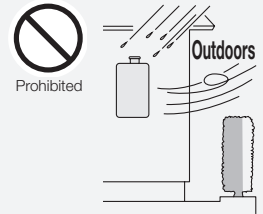

Installation Clearances



WARNING

Before installing, check for the following:

The location of the flue terminal must comply with the clearances shown on this page. If you are unsure about clearances not indicated here, in general refer to AS/NZS5601, or your local authority. In Western Australia refer to the WA Office of Energy rules and regulations.

Flue outlet must be free from any combustible material.

CLEARANCES FOR FLUE TERMINAL

The location of the flue terminal must comply with the clearances shown on this page. If you are unsure about clearances not indicated here, in general refer to AS/NZS5601, or your local authority. In Western Australia refer to the WA Office of Energy rules and regulations.

AS/NZS 5601.1:2013

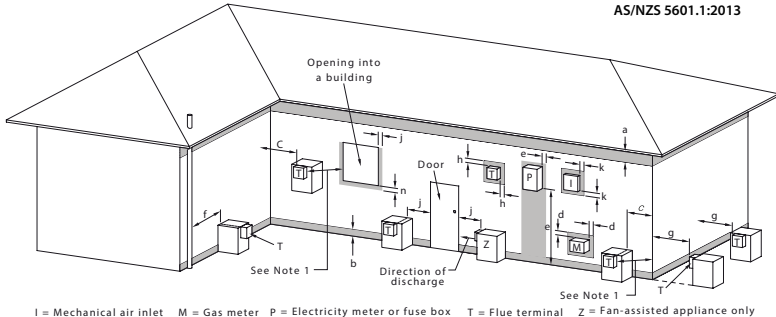

I = Mechanical air inlet M = Gas meter P = Electricity meter or fuse box T = Flue terminal Z = Fan-assisted appliance only
 ■ Shading indicates prohibited area for flue terminals

FIGURE 6.2 (in part) LOCATION OF FLUE TERMINALS OF BALANCED FLUE, ROOM-SEALED, FAN-ASSISTED OR OUTDOOR APPLIANCES

Ref.	Item	Minimum clearances mm	
			Fan assisted
a	Below eaves, balconies and other projections:		
	Appliances over 50 MJ/h input		200
	Appliances over 50 MJ/h input		300
b	From the ground, above a balcony or other surface *		300
c	From a return wall or external corner *		300
d	From a gas meter (M) (see Note 5) (see Clause 5.11.5.9 for vent terminal location of regulator) (see Table 6.7 for New Zealand requirements)		1 000
e	From an electricity meter or fuse box (P) † (see Note 5)		500
f	From a drain pipe or soil pipe		75
g	Horizontally from any building structure * or obstruction facing a terminal		500
h	From any other flue terminal, cowl, or combustion air intake *		300
j	Horizontally from an openable window, door, non-mechanical air inlet, or any other opening into a building with the exception of sub-floor ventilation:		
	Appliances over 200 MJ/h input up to 250 MJ/h input*		500
	All fan-assisted flue appliances, in the direction of discharge		1 500
k	From a mechanical air inlet, including a spa blower		1 000
n	Vertically below an openable window, non-mechanical air inlet, or any other opening into a building with the exception of sub-floor ventilation:		
			150
			500
			1 000
	Appliances over 150 MJ/h input		1 500

* Unless appliance is certified for closer installation.

† Prohibited area below electricity meter or fuse box extends to ground level.

NOTES:

- Where dimensions c, j or k cannot be achieved an equivalent horizontal distance measured diagonally from the nearest discharge point of the terminal to the opening may be deemed by the Technical Regulator to comply.
- See Clause 6.9.4 for restrictions on a flue terminal under a covered area.
- See Figure J3 for clearances required from a flue terminal to an LP Gas cylinder. A flue terminal is considered to be a source of ignition.
- For appliances not addressed above acceptance should be obtained from the Technical Regulator.
- Minimum clearances d and e also apply to any combustion air intake openings of appliances.

FIGURE 6.2 (in part) LOCATION OF FLUE TERMINALS OF BALANCED FLUE, ROOM-SEALED, FAN-ASSISTED OR OUTDOOR APPLIANCES

Installation

Securing to the wall



Be sure to do

- Installation must conform with all local building, water and Gas Regulations and AS/NZS5601.
- The weight of the device will be applied to the wall. If the strength of the wall is not sufficient, reinforcement must be done to prevent the transfer of vibration.
- Do not drop or apply unnecessary force to the device when installing. Internal parts may be damaged and may become highly dangerous.
- Install the unit on a vertical wall and ensure that it is level.
- Insure no additional pressure is applied to the pipework.

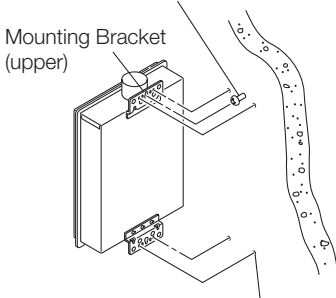
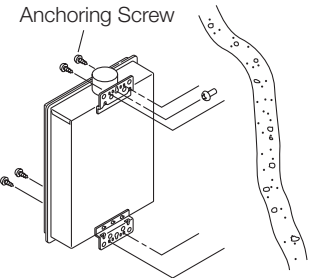
Item	Check	Illustration
Locating Screw Holes	<div style="text-align: center; margin-bottom: 10px;">  CAUTION </div> <ul style="list-style-type: none"> When installing with bare hands, take caution to not inflict injury. Be careful not to hit electrical wiring, gas, or water piping while drilling holes. <ol style="list-style-type: none"> Drill a single screw hole, making sure to hit a stud. Insert and tighten the screw and hang the unit by the upper wall mounting bracket. Determine the positions for the remaining four screws (two for the top bracket and two for the bottom), and remove the unit. 	<p>Location of Screw Hole</p>  <p>Locating Screw Holes</p>
Mounting	<ol style="list-style-type: none"> Drill holes for the remaining four screws. Hang the unit again by the first screw, and then insert and tighten the remaining four screws. Take waterproofing measures so that water does not enter the building from screws mounting the device. 	<p>Anchoring Screw</p> 
Structure	<ul style="list-style-type: none"> Make sure the unit is installed securely so that it will not fall or move due to vibrations or earthquakes. 	

Flue Piping

WARNING



Be sure to do

CARBON MONOXIDE POISONING

Follow all flue system requirements in accordance with relevant local or state regulation, or, in the absence of local or state code.

The seals supplied with the heater must be installed into the flue tubes before connecting the heater to any flueing. Failure to fit the seals may void warranty and may lead to personal injury

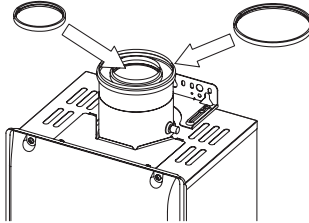

General Requirements

- Make sure the flue system is gas tight and will not leak.
- Support the flue pipe with hangers at regular intervals as specified by these instructions or the instructions of the flue manufacturer.
- Do not store hazardous or flammable substances near the flue termination and check that the termination is not blocked in any way.
- Steam or condensed water may come out from the flue termination. Select the location for the termination so as to prevent injury or property damage.
- If snow is expected to accumulate, take care the end of the pipe is not covered with snow or hit by falling lumps of snow.

Maximum Flue Length Adjustment DIP switches

The unit can be adjusted to accommodate longer flue runs; refer to the below table to find the maximum flue length based on the number of elbows. Adjust the DIP switches according to the flue condition noted in the tables below.

Note: By default, the unit has been set to the "① minimum length" condition.

- Disconnect power to the water heater before changing the DIP switches. Failure to perform this step will result in a "73" code displayed on the remote controller and a cease in operation. If this occurs, disconnect, then reconnect power to the water heater to reset the system.
Note : Please refer to page 27 for the location of the DIP switch bank.

[Maximum Flue Length Example]

- One 90° elbows, maximum length = 1 m
(with DIP switches set at "minimum length" condition)
- Two 90° elbows, maximum length = 9 m
(with DIP switches set at "maximum length" condition)

<Maximum Flue Length Configurations>

Flue length*	Elbows						
	0	1	2	3	4	5	6
1	① Minimum length						
2		② Short length					
3			③ Long length				
4				④ Maximum length			
5							
6							
7							
8							
9							
10							
11							
12							
13							

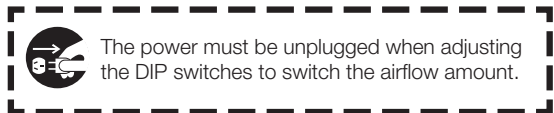

* Not including the flue terminal.

Do not change any other DIP switches.

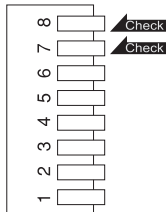
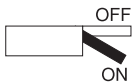

* Flue length condition.

	7	8
① Minimum length	<input type="radio"/>	<input type="radio"/>
② Short length	<input checked="" type="radio"/>	<input type="radio"/>
③ Long length	<input type="radio"/>	<input checked="" type="radio"/>
④ Maximum length	<input checked="" type="radio"/>	<input checked="" type="radio"/>

ON= ● OFF= ○

- Exceeding the maximum flue length is dangerous and may result in bad combustion.
- Install the flue terminal so that all exhaust is directed to and all intake air is taken from outdoors.
- Do not store hazardous or flammable substances near the flue terminal.
- Slope the flue pipe 50mm for every 1m either towards the horizontal termination or towards the integrated condensate collector.

When using the condensate collector, create a trap in the drain line and pre-charge it with water to prevent exhaust gas leakage.

- Maintain the same flue pipe diameter all the way to the end.
- Use only Reece specified flueing products.
- Connect the flue pipe firmly so that it will prevent exhaust gases from leaking.

- Steam or condensed water may drip out of the flue terminal. Dispose of this condensed water according to local codes and in order to prevent injury or property damage.
- If this product will be installed in an area where snow is known to accumulate, protect the flue termination from blockage by snow drifts or damage from snow falling off of roofs.
- Support the flue pipe with hangers at a minimum of every 2m.
- Make the vertical pipe as short as possible.
- Do not common flue or connect more than one appliance to this flueing system.
- Terminate at least 300mm above grade or snow line.
- Terminate at least 2.3m above a public walkway.

⚠ WARNING



Be sure to do

CARBON MONOXIDE POISONING

Do not remove the cap from the condensate collector unless it is being used to drain condensate. Without the cap in place, flue products could enter the living space.

Horizontal Flue Termination

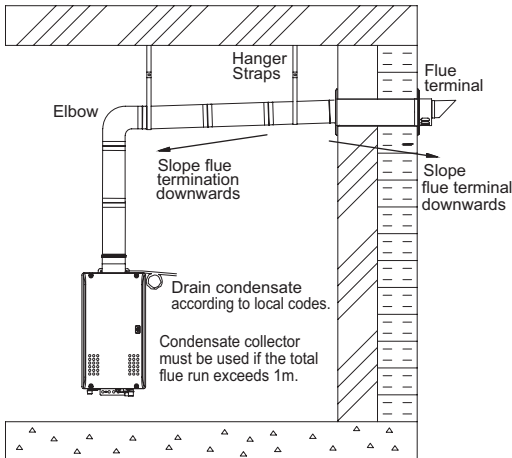

- Terminate at least 350mm above ground.
- Terminate at least 2.3m above a public walkway, 2m from the combustion air intake of any appliance, and 1m from any other building opening, gas utility meter, service regulator etc.
- Terminate at least 1m above any forced air inlet, 1.5m below, 500mm horizontally from and 300mm above any door, window, or gravity air inlet into any building as per AS5601.
- Slope the horizontal flue 50mm upwards for every 1m.
- Flue terminal must either be the outside (max. 10 mm per meter).
- Use a condensation drain if necessary.
- The integrated condensate collector must be used for total flue runs in excess of 1m. Remove the cap from the collector prior to attaching the drain line.

Vertical Flue Termination

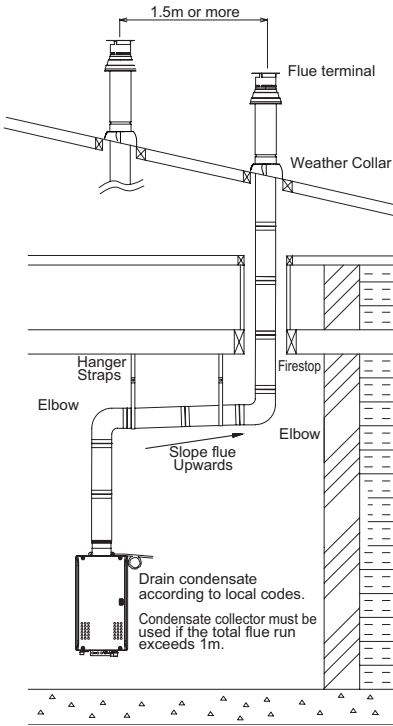

- Terminate at least 1.8m from the combustion air intake of any appliance, and 1m from any other building opening, gas utility meter, service regulator etc.
- Terminate the flue system at least 600mm above but not more than 2m above the roof line, or according to the flue pipe manufacture's instructions.
- Provide vertical support every 3.6m or as required by the flue pipe manufacturer's instructions.
- Slope the horizontal flue 50mm upwards for every 1m.
- The integrated condensate collector must be used for total flue runs in excess of 1m. Remove the cap prior to attaching the drain tubing.
- When 2 units are installed in a Quick Connect Multi System, maintain a minimum distance of 1.5m between the vertical terminations.

When the flue pipe passes through an enclosed space:

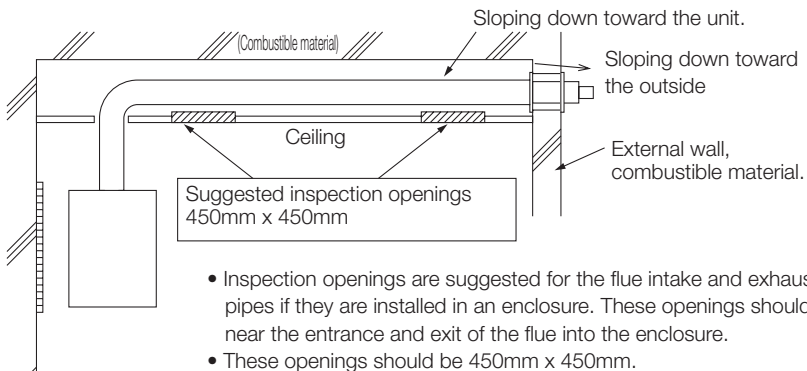

- Inspection openings are suggested for the flue intake and exhaust pipes if they are installed in an enclosure. These openings should be near the entrance and exit of the flue into the enclosure.
- These openings should be 450mm x 450mm.

Example of flue installation instruction

See individual flueing components part numbers listed under optional accessories.

Horizontal Flue Termination

General

- Store material inside.
 - Check the components on possible damages.
 - Use only flue part numbers listed under optional accessories.
 - Install after national regulation
- Fill out chimney label (when supplied) and place it near boiler adaptor.

Cleaning

Outside can be cleaned with a wet towel or with some detergent

Install products according to national regulations. Printing errors or technical alterations reserved.
In case of doubts ask sales department for advice.

Installation Sequence

1. Check the flue terminal for possible damage.
2. Determine the proposed location of the flue terminal.
3. Drill a hole through the wall of a maximum of 10 mm wider than the air supply pipe for the flue terminal. Horizontal flue terminals with flexible exterior gaskets can be installed inside out, in which case the drilled hole must be 25 mm wider than the diameter of the air supply pipe. Take due care to protect the appliance from dust and grit during drilling.

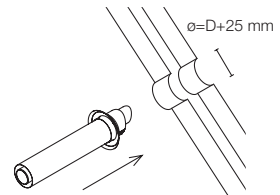
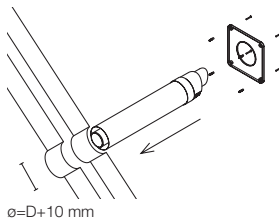
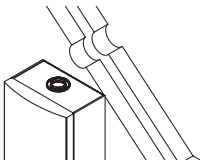

4. Determine the thickness of the wall and cut if necessary the wall terminal to the corresponding length. Remove the burs. Attention: the length is correct if the outer wall plate or rosette are flush with the outside wall.

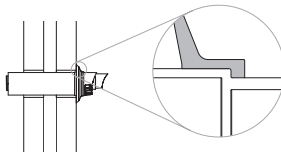
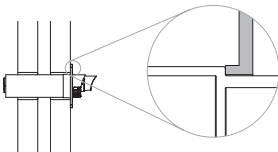

5. Insert the flue terminal into the drilled hole. The air supply pipe for the flue terminal must either be installed level or tilted slightly downwards to the outside (max. 10 mm per meter). To prevent rainwater from penetrating the system, ensure that the flue terminal is never installed up side down.

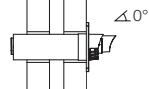

6. Close the gap between the air intake pipe and the hole in the wall with water-resistant sealant. Install the rosettes or wall plates around the flue terminal and attach with screws or kit.

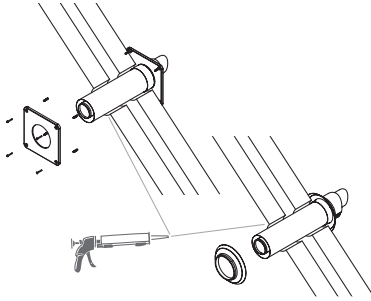

7. Connect the appliance to the terminal. Start at the outlet of the appliance. Use only water for greasing the seals.

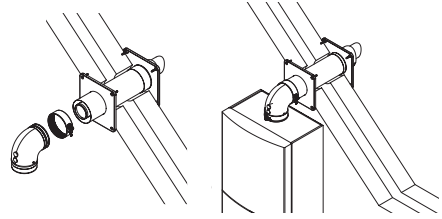

Vertical Flue Termination

General

- Store material inside.
- Check the components on possible damages.
- Use only flue part numbers listed under optional accessories.
- Install after national regulation
 - Fill out chimney label (when supplied) and place it near boiler adaptor.

Cleaning

Outside can be cleaned with a wet towel or with some detergent

Install products according to national regulations. Printing errors or technical alterations reserved. In case of doubts ask sales department for advice.

Installation Sequence

1. Check the flue terminal on any damage.

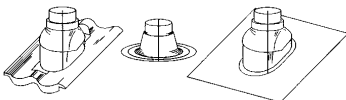

Synthetic tile Flat roof flashing Universal pitched roof flashing

2. Taking the roofing into account, determine the type of weather collar synthetic file or universal pitched roof flashing; for a flat roof an aluminium flat roof flashing.

3. Determine where the flue terminal will be positioned. With a tile roof use the universal pitched roof flashing.

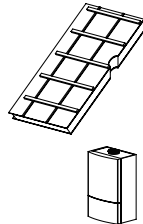

4. Make a hole for the flue terminal from the outside.
Ensure that no saw dust or dust gets into the boiler.

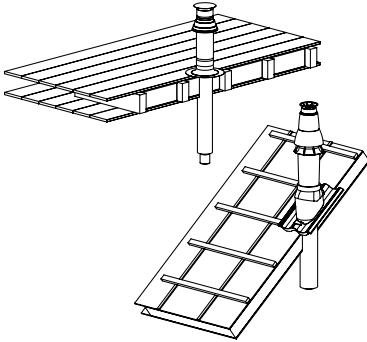

5. Fit the weather collar.

6. Carefully insert the flue terminal through the roof from the outside. Attention: do not turn the cap.

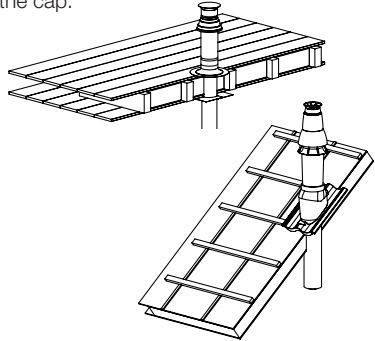

7. Put the flue terminal into a vertical position using an air level. (If desired, cover plates, to be supplied separately, can be fitted).

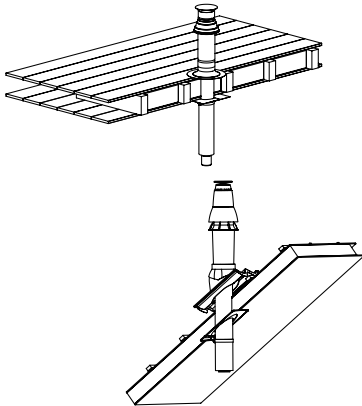

8. Fix the supplied wall clamp round the flue terminal and fit it to the roof construction. Do not tighten the clamp yet.

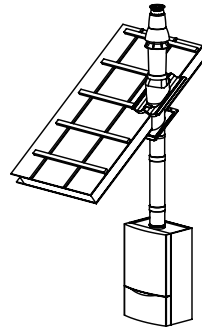

9. Depending on the type of terminal, concentric or twin tube, the installation proceeds as follows:

- concentric: Determine the length of the flue pipes and install these with the clamps in accordance with the installation instructions supplied in the package.
- twin-tube: Fit the gasket and the twin-tube connection. Make sure that the gasket is not damaged. Ensure that the flue tube and the air inlet tube are not exchanged; the flue tube is the pipe in the centre below the flue terminal.

10. Finally, secure the roof wall clamp and check that all steps have been carried out correctly.

Gas Piping

Follow the instructions from the gas supplier.

The appliance must be disconnected from the gas supply piping system during any pressure testing of that system at test pressures in excess of 3.5 kPa.

The appliance and its gas connections must be leak tested before placing the appliance in operation.

The inlet gas pressure must be within the range specified. This is for the purposes of input adjustment.

In order to choose the proper size for the gas line, consult local codes and / or the AS/NZS5601.

SEE DOCUMENT IN PLASTIC SLEEVE BEHIND FRONT COVER FOR PRESSURE ADJUSTMENTS

<p>Gas Pressure Size the gas line according to total MJ/h demand of the building and length from the meter or regulator so that the following supply pressures are available even at maximum demand refer AS/NZS5601:</p> <p>Working Gas Supply Pressures</p> <p>Natural Gas Supply Pressure Min. 1.13 kPa Max. 3.00 kPa</p> <p>ULP Gas Supply Pressure Min. 2.75 kPa Max. 3.50 kPa</p> <ul style="list-style-type: none"> • Please ensure measurement is taken when the appliance is operating at maximum load. <p>Gas Meter Select a gas meter capable of supplying the entire MJ/h demand of all gas appliances in the building.</p>	<p>Gas Connection</p> <ol style="list-style-type: none"> 1) Fit a union to the water heater gas inlet for easy connection and removal. The thread diameter is 20 mm. <u>THIS DOES NOT INDICATE THE SIZE OF THE GAS SUPPLY.</u> 2) Fit an suitably approved isolating gas cock in the supply line adjacent to the water heater gas connection. 3) Ensure that the supply pipe and the gas pressure regulator (ULPG or Natural Gas) has sufficient flow capacity for this and other appliances connected to the fitting line. 4) For ULPG appliances ensure that gas cylinders are of sufficient size. The water heater alone will require 2 x 45 Kg capacity cylinders. 5) Before connecting the appliance to the gas service, purge any debris or air from the gas service. 6) Check all joints for leaks with an approved leak tester after connection.
---	---

Measuring Gas Pressure

In order to check the gas supply pressure to the unit, a tap is provided on the gas inlet. Remove the hex head philips screw from the tap, and connect a manometer using a silicon tube.

In order to check the burner gas pressure on the gas valve inside the unit. The pressure can be checked by removing the hex head philips screw and connecting a manometer with a silicon tube.

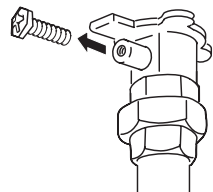

Refer to AS/NZS5601 for pipe sizing and details.

Ensure that the gas pipe size is correct. If undersized the appliance will not operate correctly

SERVICE CALLS ARE CHARGEABLE FOR UNITS WITH INCORRECT PIPE SIZES OR BLOCKED GAS OR WATER FILTERS.

Water Piping

Installation and service must be performed by a qualified plumber. Observe all applicable codes.

This appliance is suitable for potable water applications. Do not use this appliance if any part has been underwater. Immediately call a qualified service technician to inspect the appliance and replace any part of the control system and gas control which has been under water.

Piping and components connected to the water heater shall be suitable for use with potable water.

Toxic chemicals, such as those used for boiler treatment, shall not be introduced into the potable water.

A water heater used to supply potable water may not be connected to any heating system or components previously used with a non-potable water heating appliance.

When water is required in one part of the system at a higher temperature than in the rest of the system, means such as a mixing valve shall be installed to temper the water to reduce the scald hazard.

- Flush water through the pipe to clean out metal powder, sand and dirt before connecting it.
- Perform the following insulation measures for prevention of freezing.
 - Take appropriate heat insulation measures (e.g., wrapping with heat insulation materials, using electric heaters) according to the climate of the region to prevent the pipe from freezing.
 - Make sure that there are no water leaks from the cold and hot water supply pipes, then insulate the pipes completely.
 - Be sure to also completely insulate the water supply valve and the cold and hot water connections on the water heater (refer to the figure on the right).
 - Do not cover the water drain plug with insulation so that water in the pipe can be drained. (Refer to the figure in the right.)
- Use a union coupling for connecting the pipes to reduce the force applied to the piping.
- When feed water pressure is too high, insert a depressurizing valve, or take water hammer prevention measure.
- Avoid using joints as much as possible to keep the piping simple.
- Avoid piping in which an air lock can occur.
- Use approved piping materials.
- If installing the unit on a roof (Above lower-level hot water supply):
 - If the unit is installed on a roof to supply water to the levels below, make sure that the water pressure supplied to the unit does not drop below 199 kPa. It may be necessary to install a pump system to ensure that the water pressure is maintained at this level.

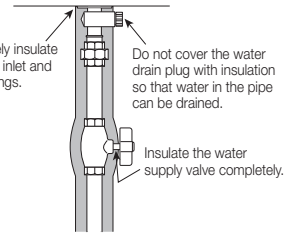

Check the pressure before putting the unit into operation.

Failure to supply the proper pressure to the unit may result in noisy operation, shorter lifetime of the unit, and may cause the unit to shut down frequently.

Supply water piping

- Do not use PVC, iron, or any piping which has been treated with chromates, boiler seal or other chemicals.
- Pipe sizing from the cold water supply should be sized according to local BY LAWS for water supply.
- If sludge or foreign matter is present in the water supply it is recommended that a separate filter/strainer be fitted to the cold water supply line.
- A GATE VALVE OR BALL VALVE must be used on the cold water inlet to the water heater. THIS REQUIREMENT IS AN AUSTRALIA WIDE REQUIREMENT UNDER THE NATIONAL PLUMBING CODE.

STOP TAPS OR COMBINATION STOP TAPS AND NON-RETURN VALVES ARE NOT TO BE USED.

- In order for the client to use the water heater comfortably, 200 to 1000 kPa of pressure is needed from the water supply.

Be sure to check the water pressure. If the water pressure is low, the water heater cannot perform to its full capability, and may become a source of trouble for the client.



Please ensure this appliance does not receive inlet water greater than 85°C when used as a Solar booster.

Drain processing

- Expansion water may drop from the pressure relief valve and wet the floor.

Hot water piping

- Do not use lead, PVC, iron or any piping which has been treated with chromates, boiler seal or other chemicals.
- Keep the pipe lengths to a minimum, and make sure that the pipework is well insulated as correct performance of the appliance is dependent on properly insulated pipework.
- DO NOT FIT ANY VALVES OR RESTRICTORS TO THE OUTLET OF THE WATER HEATER.
- DO NOT FIT ANY OBSTRUCTION TO THE PRESSURE RELIEF LOCATED ON THE HOT WATER OUTLET CONNECTION.
- Use mixing valves with low water resistance. Use shower heads with low pressure loss.
- If necessary, use a pump or other means to ensure that the supply water pressure to the inlet of the heater does not fall below 199 kPa when the maximum amount of water is being demanded. If the water pressure drops below 200 kPa, local boiling can occur inside the water heater causing abnormal sounds and decreasing the durability of the heat exchanger.

After purging the air from the system using the hot water supply taps, remove the water inlet strainer located on the cold water supply inlet connection. Remove any debris from the filter and replace. When replacing the filter, do not over-tighten the "O" ring seal.



No pressure reduction is required unless the water pressure exceeds 1000kPa.

Electrical Wiring

WARNING

Electrical Shock Hazard

Do not turn power on until controllers have been connected. Disconnect power before servicing.
Failure to do so may result in death or serious injury from electrical shock.

- The appliance is equipped with a 1.5m cable with a three pinned earthed plug to be connected to 230 - 240VAC at 50 Hz.
The power consumption may be up to 193W.
Use an appropriate circuit.
- The appliance requires a 240V in Australia and 230V in New Zealand, 50Hz weatherproof plug installed in a protected position adjacent to the appliance.
- If the power cord is damaged and requires replacement, use only an original spare part available from the manufacturer.
- Do not disconnect the power supply when not in use. When the power is off, the freeze prevention in the water heater will not activate, resulting in possible freezing damage.
- Do not let the power cord contact the gas piping.

Tie the excess power cord outside the water heater. Putting the redundant length of cord inside the water heater may cause electrical interference and faulty operation.

Earth

- To prevent electrical shock, always plug power lead into an earthed point.

CAUTION

Electrostatic discharge can affect electronic components. Take precautions to prevent electrostatic discharges from personnel or hand tools during the water heater installation and servicing to protect product's electronic control.

Remote Controller

Remote controller	RC-9018C	Max temperature 85°C *
-------------------	----------	------------------------

* Maximum temperature is controlled by the maximum default temperature set in the water heater.

* Only one the remote controller can be connected to the water heater.
A malfunction may occur if two or more remote controllers are connected.

To ensure compliance with Australian Standard AS/NZS3500.4, for sanitary areas, install the water heater with a tempering valve. In New Zealand, please refer to the New Zealand Building Code and all other applicable electrical, gas fitting and plumbing codes.

The maximum temperature allowed can be changed with adjusting the DIP switches as described below.

<The changing procedure of the maximum temperature setting.>
1. Turn the water heater off by pressing the ON/OFF button on the remote controller.

2. Disconnect electrical power to the water heater.

3. Remove the front cover of the water heater (4 screws).
4. Adjust the DIP switches as illustrated below.
5. Replace the front cover of the water heater (4 screws).
6. Reconnect electrical power to the water heater.

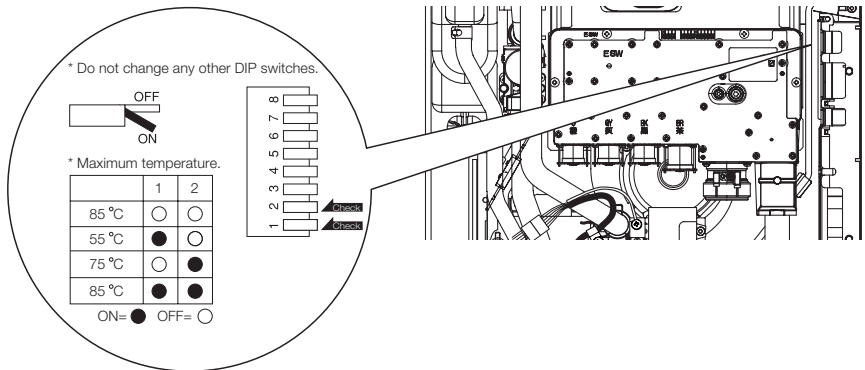

WARNING

- When changing the temperature, make sure to confirm with the customer that the temperature of the hot water will be very high and that there is a risk of scalding.

Connecting Remote Controller Cord to Unit

- Tie the excess cord outside the water heater. Do not put the extra length inside the water heater.
- The remote controller cord can be extended up to 100m.
- Be sure to hand tighten when screwing to the terminal block. Power tools may cause damage to the terminal block.

Remote controller cord

- Use remote controller cord for any extensions.
 - Install according to the National Electrical Code and all applicable local codes.
1. Disconnect electrical power to the water heater.
 2. Leave enough slack so that the remote controller cord will not be damaged if the unit is removed from the wall.
 3. Remove the front cover of the heater (4 screws).
 4. Pass the remote controller cord through the wiring throughway and into the unit.
 5. Connect the Y terminals at the end of the remote controller cord to the terminal block.
 6. Secure the remote controller cord with a clamp.
 7. Replace the front cover.

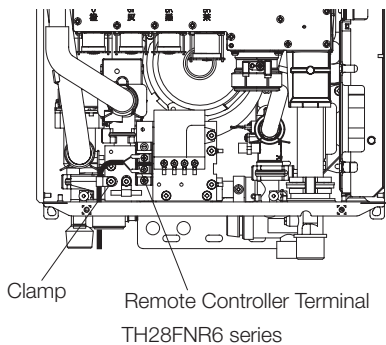

Connecting Quick Connect Cord-2

For Quick Connect Multi System Installation use part #QC-2 only. (sold separately).

Caution

The wire coloring on the Quick Connect Cord-2 will not be the same as the wire coloring of the connection plug inside the unit.

* The remote controller can be connected to either unit A or B. Do not connect a remote controller to both units.

* Disconnect the remote controller from either unit A or B prior to installing the Quick Connect Cord.

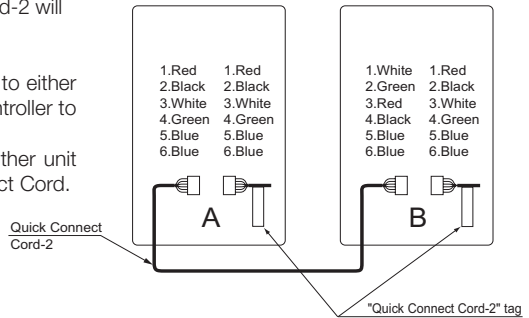

Connecting the Quick Connect Cord to the two units.

1. Turn off the power.
2. Remove the front cover of the heater (4 screws).
3. Pass the Quick Connect Cord through the wiring throughway and into the unit.
4. Plug the connector on the Quick Connect Cord to the receptacle inside the unit.
5. Attach the ground wire of the Quick Connect Cord to the terminal block fixing plate.
(If the ground wire is not attached, electrical noise may cause problems).
6. Secure the Quick Connect Cord with a clamp.
7. Replace the front cover.

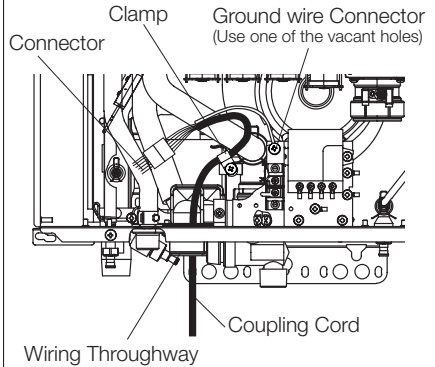

Maintenance

Periodically check the following to ensure proper operation of the water heater.

- The flueing system must be examined periodically by a qualified service technician to check for any leaks or corrosion.
- The burner flame must be checked periodically for a proper blue color and consistency.
- If the flame does not appear normal, the burner may need to be cleaned.
- If the burner needs to be cleaned, it must be performed by a qualified service technician.
- Do not obstruct the flow of combustion and ventilation air.
- See Owner's Guide for further maintenance or consult Reece for recommended service checks.

Warning: There is a scald potential if the output temperature is set too high.

Should overheating occur, or the gas supply fail to shut off, turn off the manual gas control valve to the appliance.

Do not use this appliance if any part has been under water. Immediately call a qualified service technician to inspect the appliance and to replace any part of the control system and any gas control which has been under water.

Periodically check and clean the filter inside the cold water inlet of the unit.

Servicing by qualified technician should be performed every two years.

Trial Operation

The installer should test operate the unit, explain to the customer how to use the unit, and give the owner this manual before leaving the installation.

- Preparation (1) Open a hot water fixture to confirm that water is available, and then close the fixture.
 - (2) Open the gas supply valve.
 - (3) Turn on the power supply. Using the remote controller, turn on the Power ON/OFF button (the Operation lamp will turn on).
- (1) Open a hot water fixture and confirm that the Burner on lamp comes on, and that hot water is being produced. (If necessary, repeat until the air in the gas piping is bled out).
 - * White smoke may be noticed from the exhaust flue during cold weather. However, this is not a malfunction of the unit.
 - * If an "11" error code appears on the remote controller, turn the unit off and then back on again, and then open a hot water fixture again.
- (2) Change the temperature setting on the remote controller and check that the water temperature changes.
- If the water heater does not operate normally, refer to "Troubleshooting" in the Owner's Guide.
- * After the trial operation, clean the filter in the cold water inlet.

<If installed with a quick connect multi-system>

- Turn the system power ON with the remote controller.
- Slowly open a hot water fixture and check that the units ignite sequentially. Check to see that the hot water temperature is the same as the temperature displayed on the remote controller (*1)
- * If both units do not ignite, switch which unit will ignite first by pressing the Max. or Min. Mani-fold Pressure Set Button on the circuit board. (*2)



- * If an 11 or F11 error code flashes on the remote controller, hit the Power Button on the remote controller off and on 2 -3 times.
- * If (*1) and (*2) cannot be done, the Quick Connect Cord may not be properly connected. Check that the cord is properly connected.

CAUTION

Handling after trial operation

- If the unit will not be used immediately, close off all gas and water shut off valves, drain all of the water out of the unit and the plumbing system to prevent the unit and system from freezing, and bleed the gas out of the gas line.
- Freezing is not covered by the warranty.



WARNING

A fire or explosion may result if these instructions are not followed, which may cause loss of life, personal injury or property damage.

Lighting Instructions

This water heater does not have a pilot. It is equipped with an ignition device that automatically lights the burner.

Do not try to light the burner by hand.

1. Read the safety information in the installation manual or on the right side of the water heater.
2. Turn off all electrical power to the unit.
3. Do not attempt to light the burner by hand.
4. Turn the gas control manual valve (external to the unit) clockwise to the off position.
5. Wait five minutes to clear out any gas. If the smell of gas remains, stop, and follow the instructions on page 3 of Owner's Guide.
6. Turn the gas control manual valve counterclockwise to the on position.
7. Turn on electric power to the unit.
8. The unit will now operate whenever hot water is called for. If the unit will not operate, follow the shutdown instructions and call a service technician.

Shutdown Instructions

1. Stop any water demand.
2. Turn off electric power.
3. Turn the gas control manual valve clockwise to the off position.

Should overheating occur, or the gas supply fail to shut off, turn off the manual control valve to the appliance.

WATER QUALITY

All Thermann water heating appliances are constructed from high quality materials and components and all are certified for compliance with relevant parts of Australian and New Zealand gas, electrical and water standards.

Whilst Thermann water heaters are warranted against defects, the warranty is conditional upon correct installation and use, in accordance with detailed instructions provided with the heater. In the case of the water supplied to the heater, it is important that the water quality be of acceptable standard.

The water quality limits/parameters listed in water quality table are considered acceptable and generally, Australian and New Zealand suburban water supplies fall within these limits/parameters.

In areas of Australia and New Zealand where water may be supplied, either fully or partly, from bores, artesian wells or similar, one or more of the important limits may well be exceeded and the heater could, therefore, be at risk of failure.

Where uncertainty exists concerning water quality, intending appliance users should seek a water analysis from the water supplying authority and in cases where it is established that the water supply does not meet the quality requirements of the water quality table, the warranty would not apply.

WATER QUALITY TABLE

Maximum levels

pH	Saturation Index(LSI) (langelier)	Total Hardness	Chlorides	Sodium	Iron
6.5-9	+0.4 to Minus 1.0 @65C	200mg/l	250mg/l	180mg/l	1mg/l

Multi-System

A. Installation without a recirculation system (Using external system controller) (Standard System)

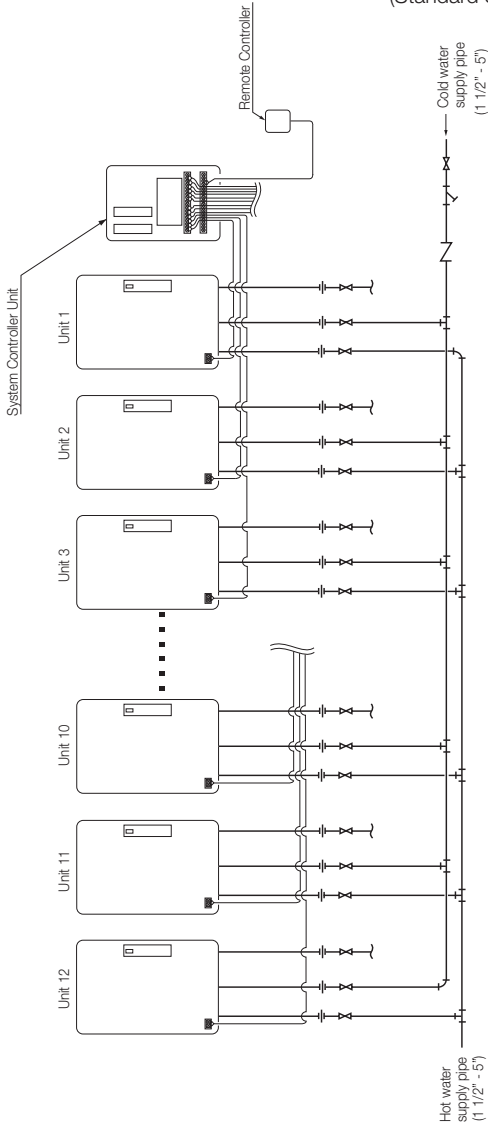

- Insulate or apply heating materials to both the cold water supply piping and the hot water supply piping to prevent freezing during cold weather and to prevent heat loss through the piping.

B-1. Example of Recirculation with a Multi-System (Using external system controller)
(Recirculation system)

This system will make hot water more quickly available to remote fixtures. The pump will circulate water through the loop until the entire loop is warm, and then the system controller will turn off the pump until the loop cools down.

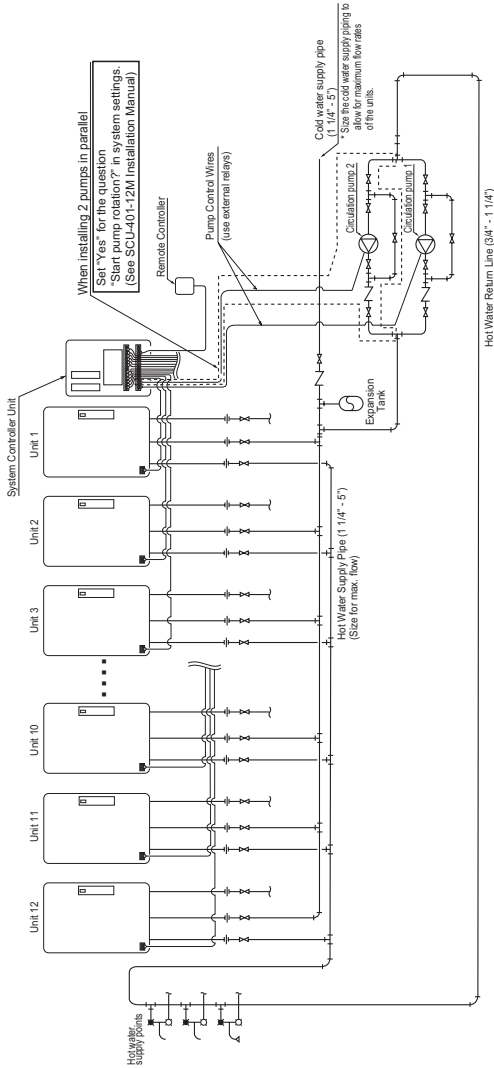

- * Size the pump to provide at least 8 L/min @ 3 m of head + piping losses through the system. Check the maintenance monitors on the unit to make sure the pump is providing adequate flow.
- Make sure that the flow rate is not greater than 1.2 m/sec. (3/4": 20 L/min, 1 1/4": 50 L/min)
- * If the flow is too low, the recirculation loop temperature will not be warm enough, if the flow is too high, the lifetime of the unit will be reduced.
- * If there are multiple circulation loops, try to make the flow rate .3-5 L/min in each loop.
- * Use copper or stainless water piping for the entire system.

B-2. Example of Installation with a Storage Tank and Recirculation System (Using external system controller)
(Tank recirculation system)

The pump will push water through the Multi-System to heat up the tank. When the temperature of the thermostat is high, the system controller will turn off the pump until the temperature cools down.

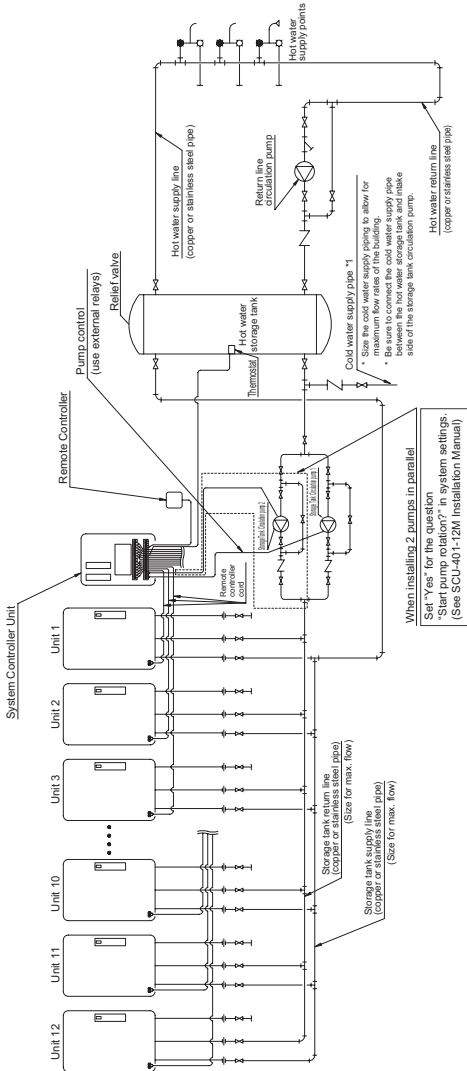

- * For the set temperature of the remote controller, use the temperature (of the thermostat) + about 5 °C.
- * To achieve the highest recovery, size the storage tank recirculation pump for maximum capacity.
(26 L/min (each) @ 10 m of head (75 °C setting or less) + piping losses through the system.)
Verify the supply pressure to the units is at least 200 Kpa.

CAUTION

- The below diagram shows the connection of 3 units to the system controller. When connecting 4 or more units, follow the same procedure.
- Connect the water heaters to the system controller following the detailed wiring instructions included with the system controller.
- Always connect a remote controller to the system controller. Do not connect the included remote controllers to the individual water heaters. These remote controllers will not be used.

* The remote controller terminal location may differ depending on the unit.

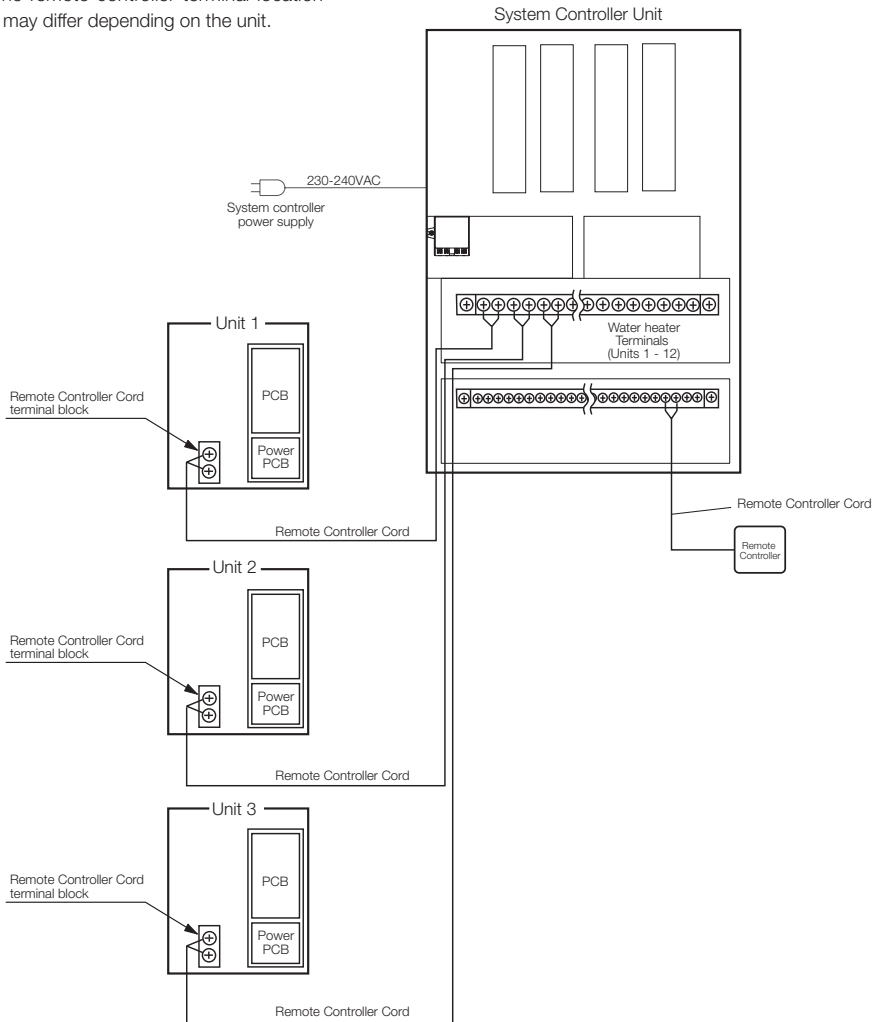

Memo

Memo

