

Rheem Recess Box

299427 (12-26L), 299831 (27L)

Features & Benefits

- Galvanised Steel
- Especially designed for standard double brick construction, WA models suit solid brick construction
- In-built anti-theft bracket
- Easy access door

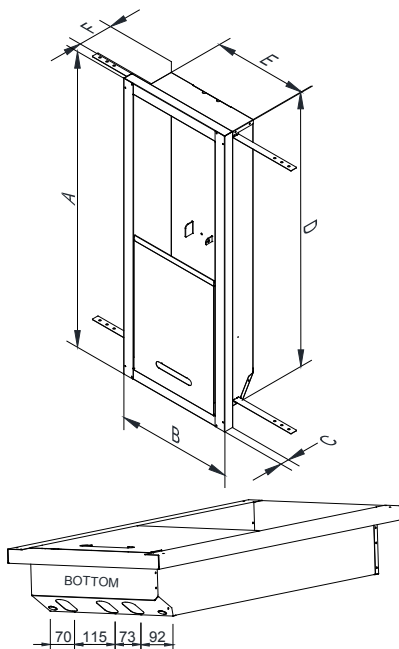

PART NO.	FASCIA			CAVITY		
	Height	Width	Depth	Height	Width	Depth
	A	B	C	D	E	F
299427 (12-26L)	1088	428	35	1010	349	128
299831 (27L)	1081	435	50	1016	353	160
299831/WA (27L)	1090	435	85	1018	353	125

The installation position of the Rheem Continuous Flow unit must comply with AS 5601 or AS/NZS 5601.1. This should be considered when choosing the installation position of the Recess box.

For installation in a bushfire attack level (BAL) zone, any gap in the recess box of 2mm or greater must be sealed with a suitable material approved for these areas.



Scan code for details & installation instructions

