



AFA Flow Single Bowl Undermount Sink No Taphole 768mm Stainless Steel

UNDERMOUNT INSTALLATION:

Stone & Solid Benchtops

1. Use the template provided to trace the cutout on both the benchtop and the underlay/timber lining
2. Cutout the benchtop and the underlay/timber lining
- 3a. **If using the sandwich technique**, silicone both the underneath rim of the undermount bowl and around the underlay/timber lining cutout
- 3b. **If using fixing clips**, follow the installation instructions for wooden/laminate benchtops or affix wooden blocks to the underside of the benchtop to screw fixing clips into
4. Place the sink into position
5. Silicone around the lip of the sink to seal between the benchtop and the sink surfaces
6. Finish by placing the benchtop back into position, sandwiching the bowl between the benchtop and the underlay/timber lining

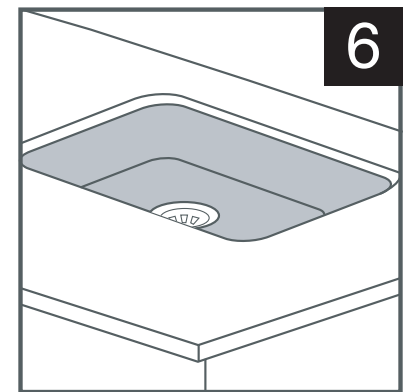
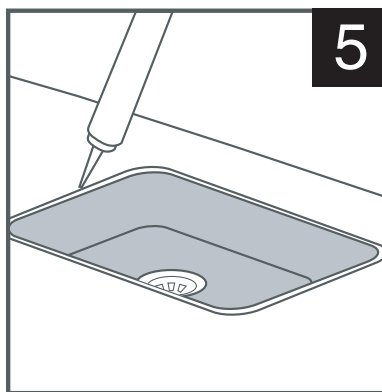
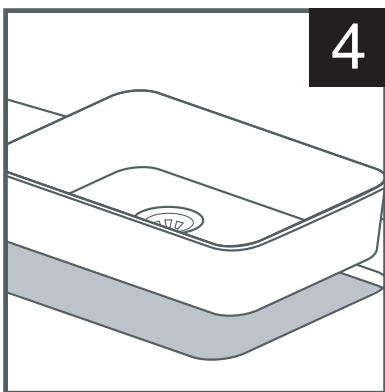
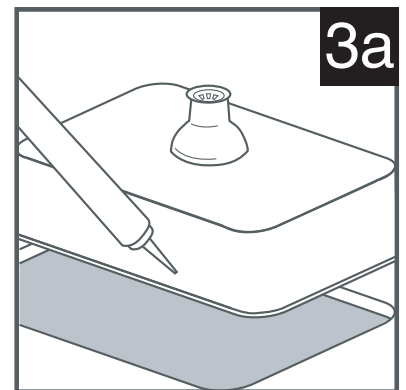
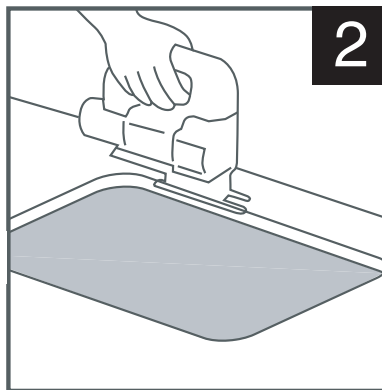
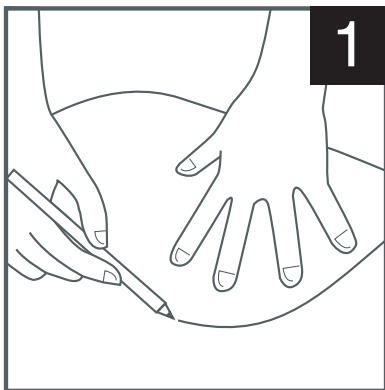

NOTE:

- If wall mounted tapware is to be used, consideration should be made to the length of the outlet and the positioning of the sink in the benchtop
- If tapware is to be bench mounted, allow a suitable benchtop width for fitting tapware
- Cut out options on template for flush fit or exposed sink edge

Plumbers, please ensure a copy of the Installation Instructions are left with the end user for future reference



AFA Flow Single Bowl Undermount Sink No Taphole 768mm Stainless Steel

UNDERMOUNT INSTALLATION:

Wooden & Laminate Benchtops

1. Use the template provided to trace the cutout on both the benchtop and the underlay
2. Cutout the benchtop and the underlay
- 3b. Position the sink underneath the benchtop and mark out the position for the fixing clips
4. Apply sealant/adhesive to the rim of the sink and position underneath the benchtop. Install all securing clips and remove excess sealant

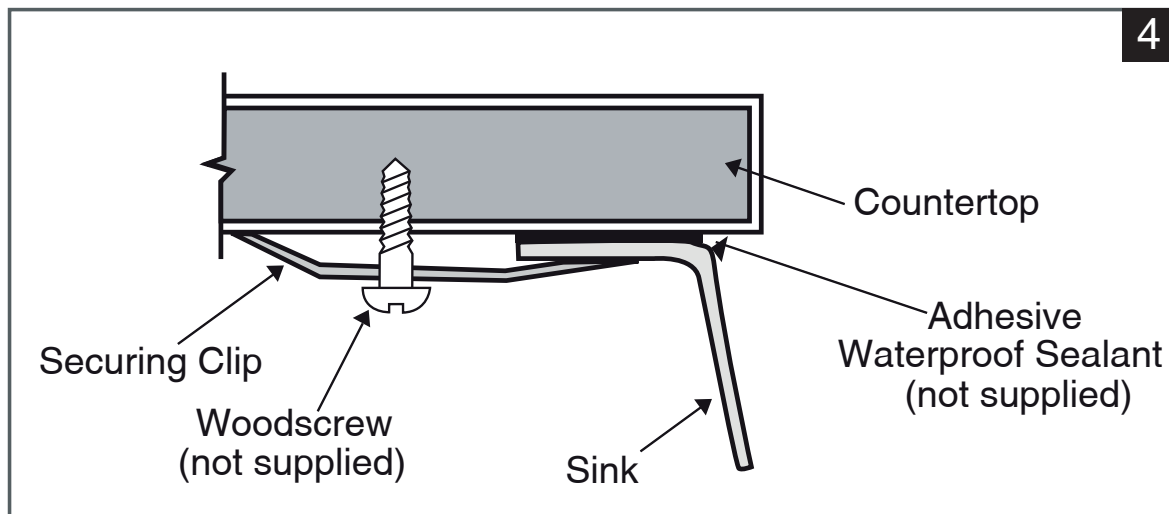
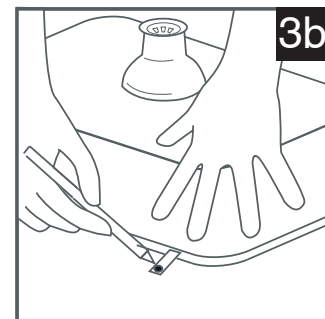
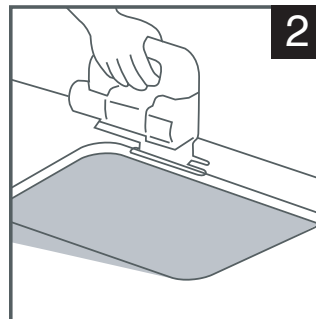
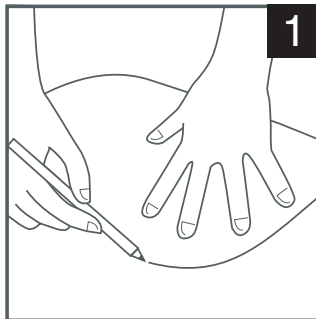

NOTE:

- If wall mounted tapware is to be used, consideration should be made to the length of the outlet and the positioning of the sink in the benchtop
- If tapware is to be bench mounted, allow a suitable benchtop width for fitting tapware
- Cut out options on template for flush fit or exposed sink edge

CLEANING RECOMMENDATIONS:

We recommend the use of soapy water or approved cleaners. This product should not be cleaned with abrasive materials. Damage caused by any improper treatment is not covered by the product warranty. Refer to Warranty Conditions