

## FRAMED FIXED PANEL



To see the complete CUSTOM GLASS range go to [www.reece.com.au/bathrooms](http://www.reece.com.au/bathrooms)

### SPECIFICATIONS

<b>Recommended use</b>	Domestic, Hotel, and Commercial
<b>Material</b>	Panel-6mm Low Iron Toughened Glass. Australian Safety Standards Compliant.
<b>Floor Suitability</b>	Tiled Floor Installation
<b>Frame &amp; Support Rail Colour</b>	Black
<b>Optional Extras</b>	1789912 - Installation Charge 1791295 - Shower Screen Removal

### SIZE VARIATIONS

Code	SIZE	HEIGHT
1789884	900	2000
1789885	1000	2000
1789886	1100	2000
1789887	1200	2000

### CLEANING RECOMMENDATIONS

We recommend the use of soapy water or approved cleaners.

This product should not be cleaned with abrasive materials.

Damage caused by any improper treatment is not covered by the product warranty - refer to Warranty Conditions.

Please refer to detailed Cleaning Instructions on page 12.

**FRAMED FIXED PANEL**

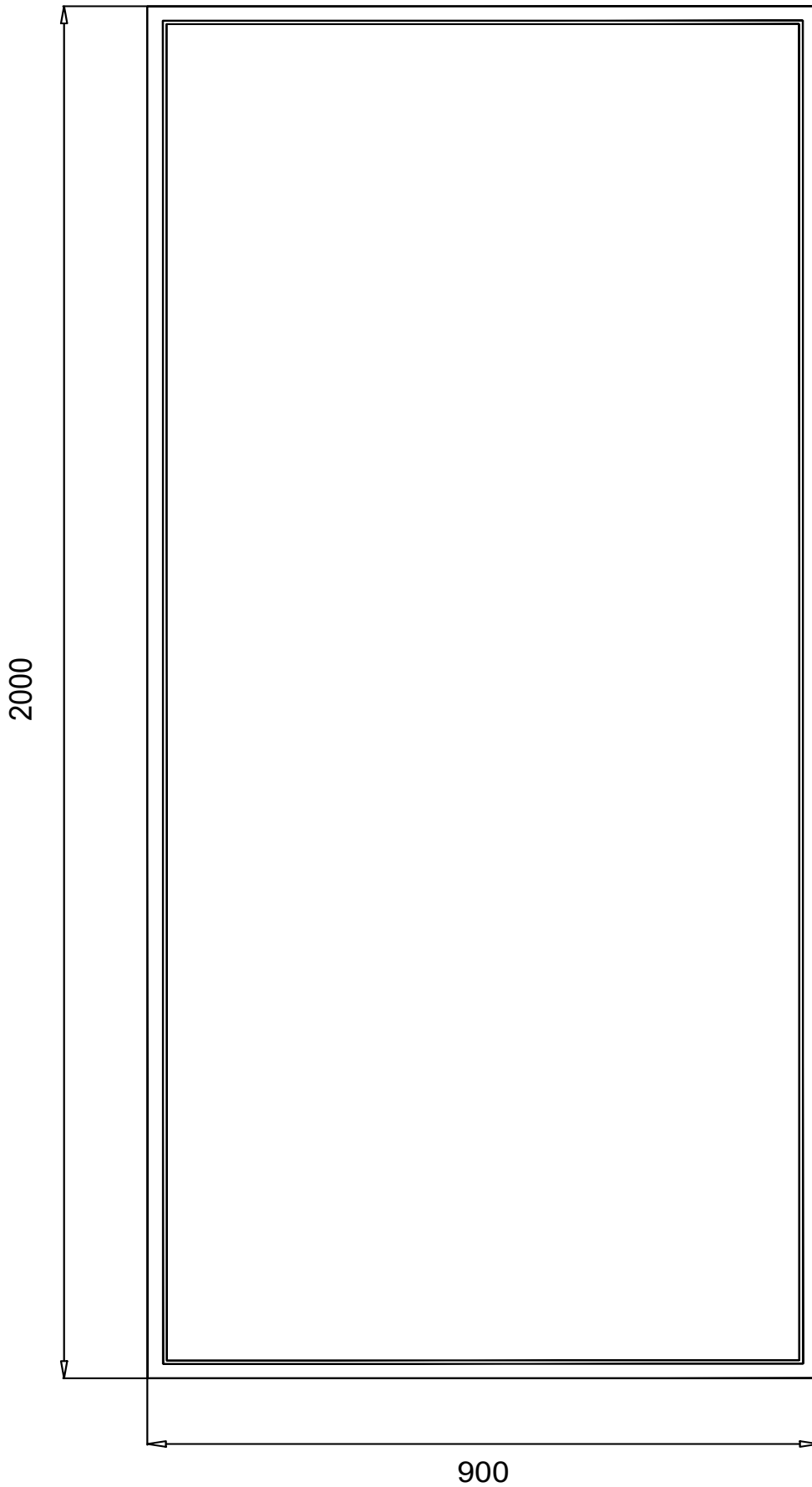

Dimensions are nominal measurements only.  
Dimensions are shown in Millimetres



## FRAMED FIXED PANEL

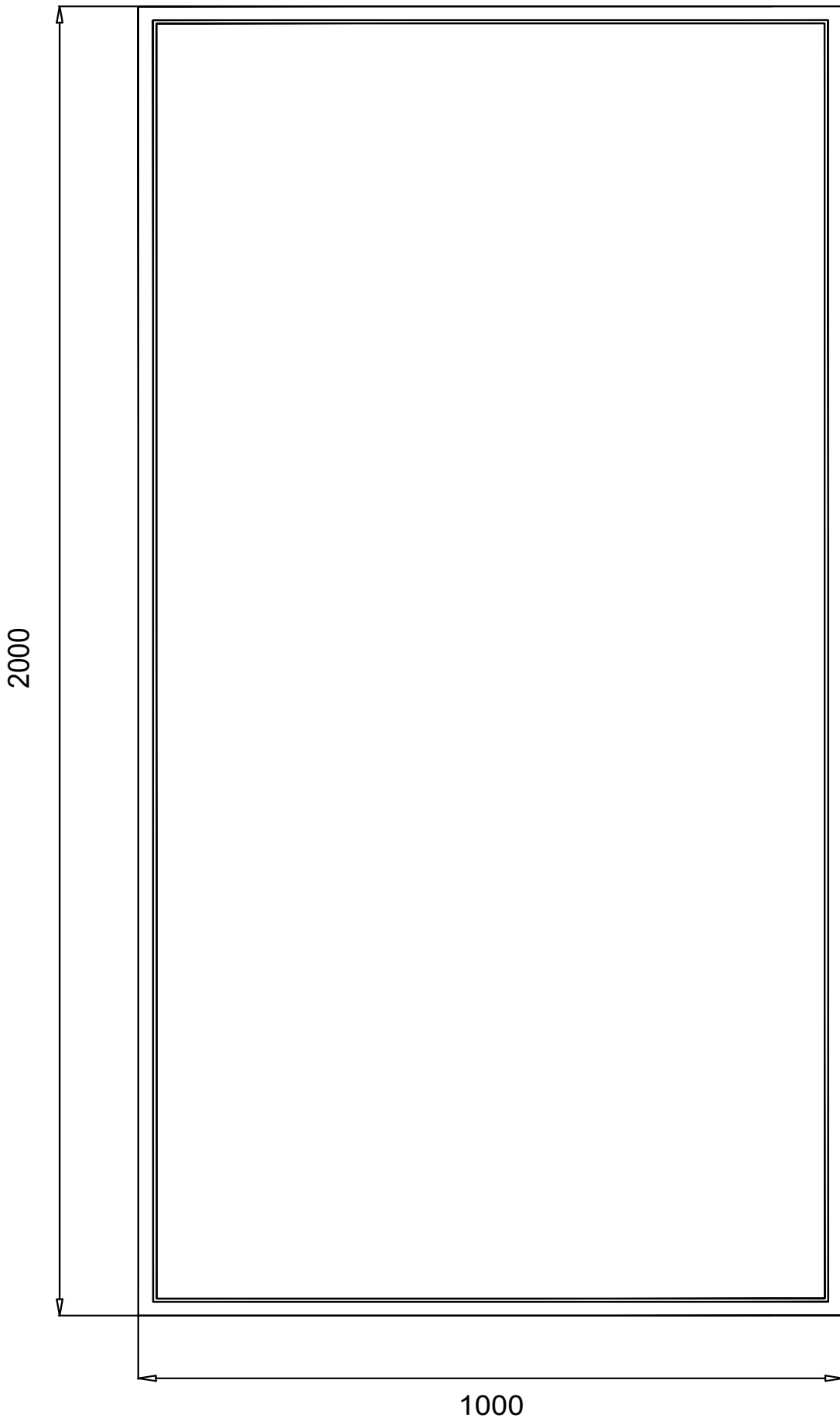



CREATIVE GLASS

FRAMED FIXED PANEL

2000

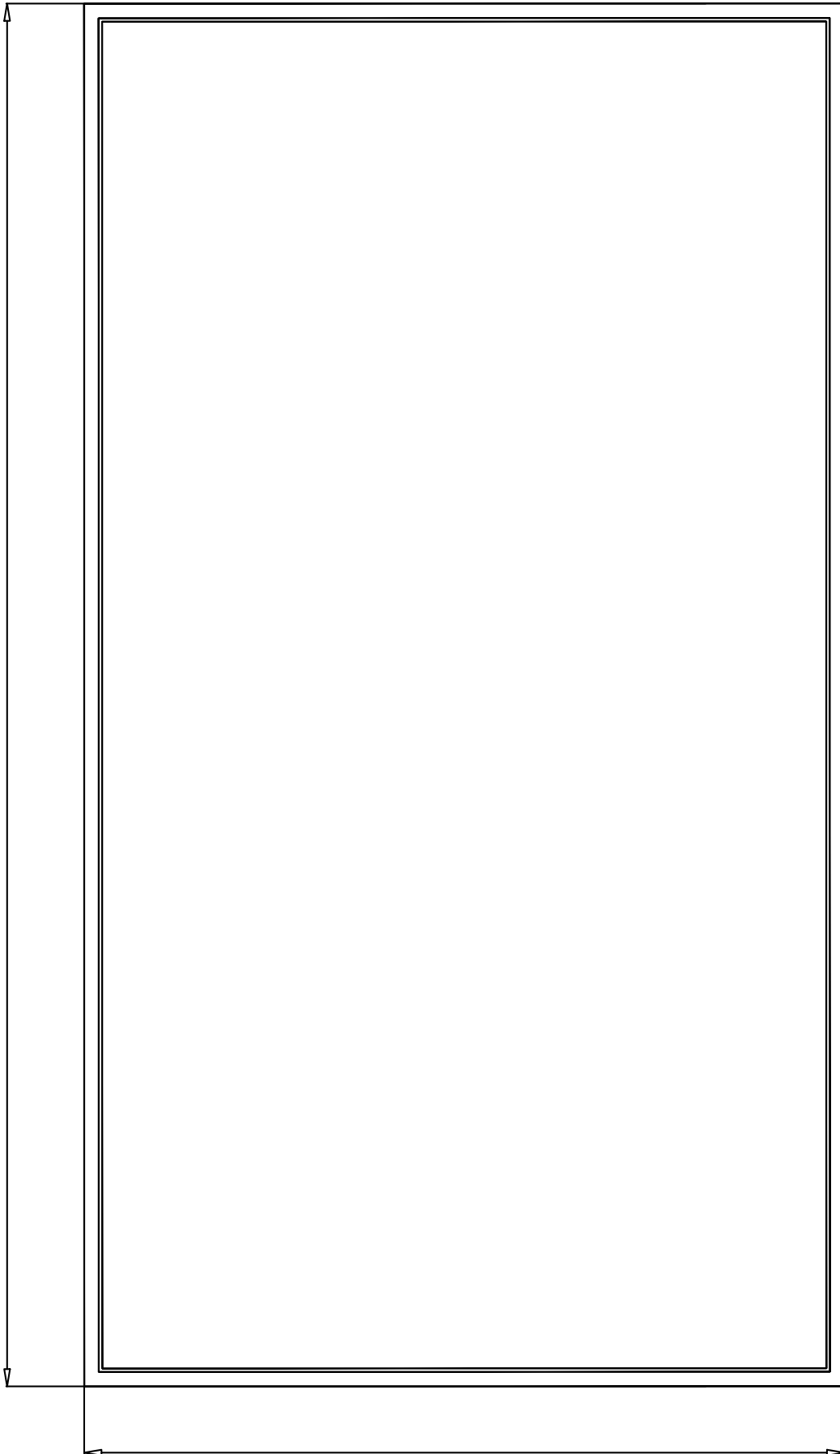

1100

**FRAMED FIXED PANEL**

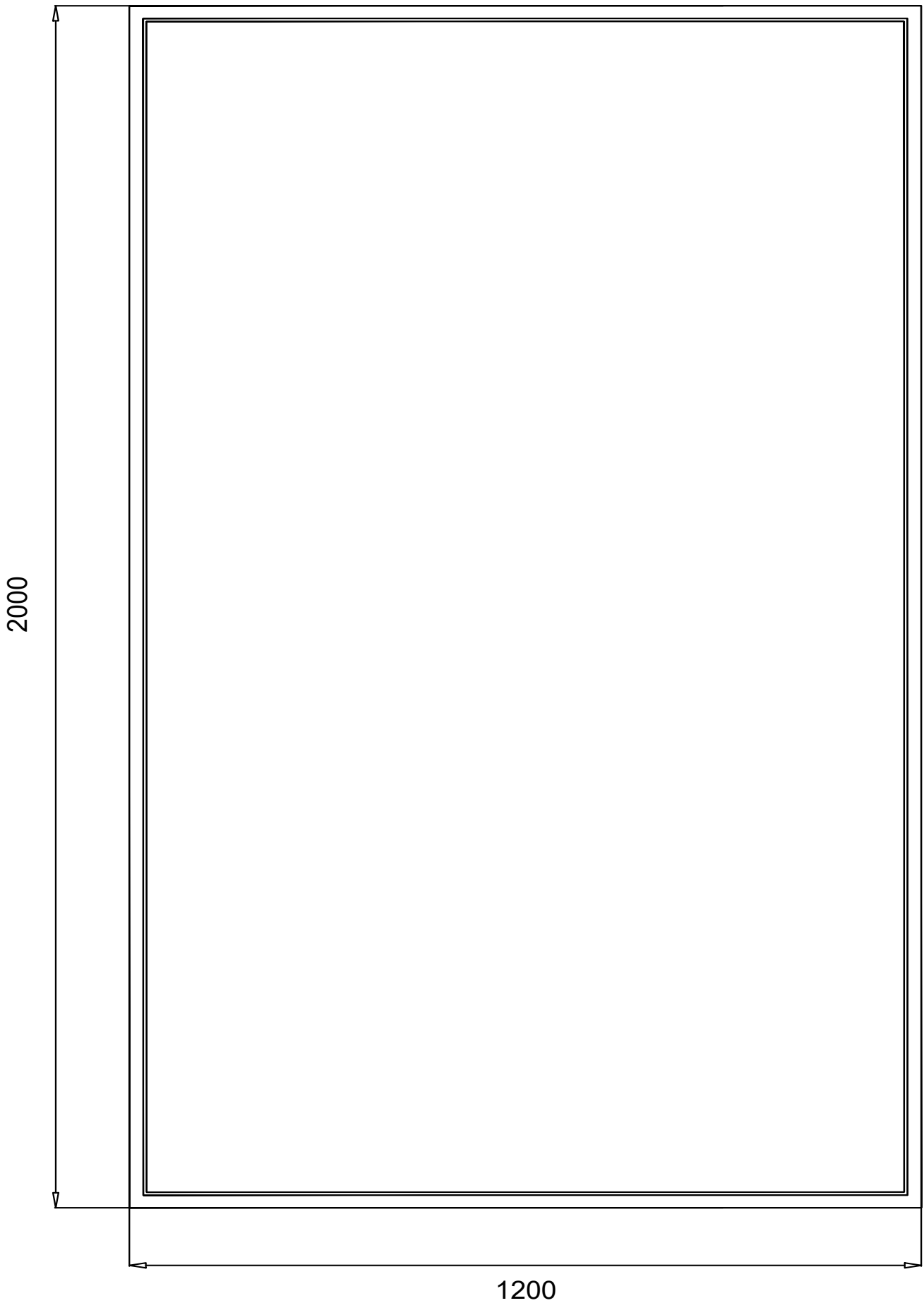

## FRAMED FIXED PANEL

### Important Pre-Installation Information

- Please read this entire instruction book before commencing installation.
- A licensed tradesman must be used for the installation.
- Please ensure all tiles are grouted and silicone work is completed before attempting to install this product

### Maintenance

If water alone is not enough to clean the glass, Custom Glass recommends the use of mild detergent solutions only.

### Tools Required



Silicone Sealant



Drill



Level



Rubber Mallet



Pencil

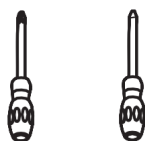

Phillips Screwdriver



Tape Measure



Cutting Pliers



Utility Knife



6mm (1/4") and  
3mm (1/8") Drill Bits



Safety Goggles





Gloves

\* Use the correct type of drill bit for the material being drilled, with 6mm required for anchor fixing and 3mm used for screwing directly into the wall studs.

\*\* As with all toughened glass, take care while handling and wear safety goggles and gloves for personal protection.

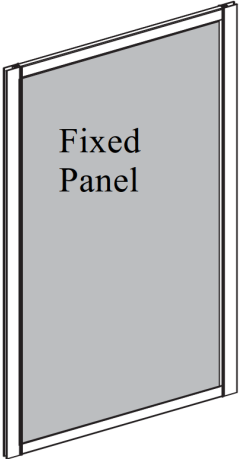
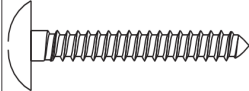
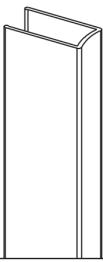
**FRAMED FIXED PANEL**  
**COMPONENTS**
**Fixed Panel Items**

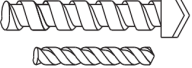
NO.	Designation	Pieces	NO.	Designation	Pieces
1	 Fixed Panel	X1	4	 ST4X35	X4
2	 Wall Channel	X1	6	 ST4X10	X4
3	<b>Fixings</b>  $\phi 8$	X4	<b>Not Supplied</b>  $\phi 8$ $\phi 3.2$		

## FRAMED FIXED PANEL

### FIXED PANEL INSTRUCTIONS

1.

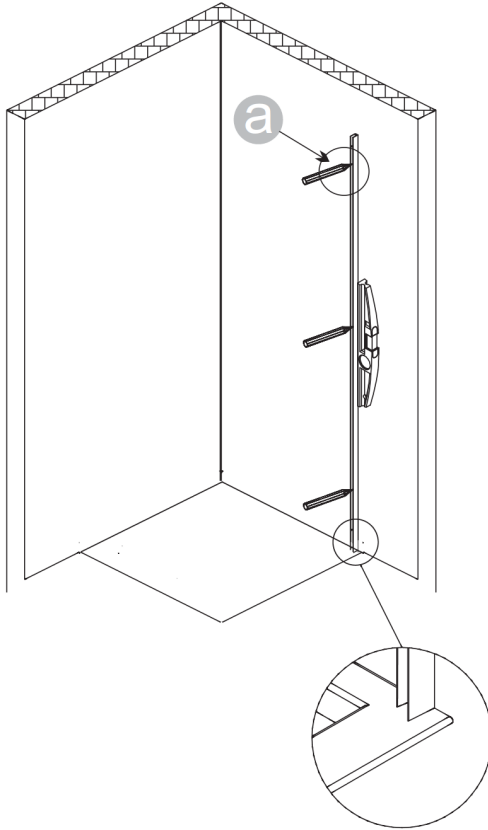

Wall Channel must be level

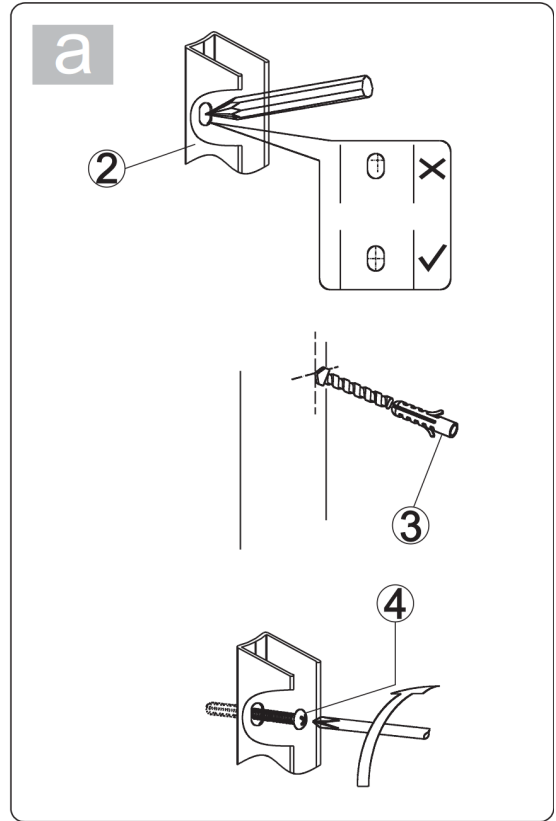

2.

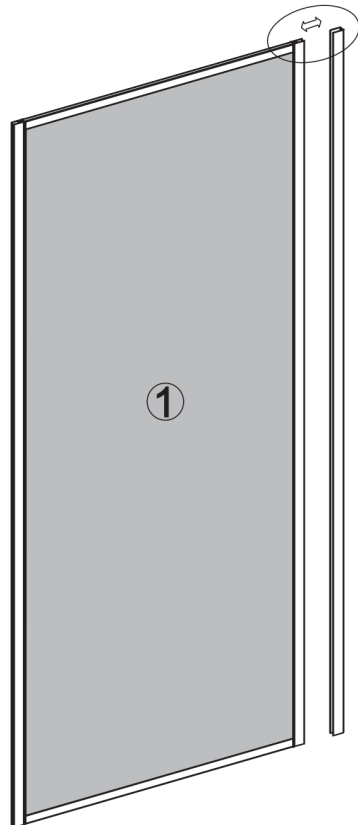

Insert Panel into the wall Channel

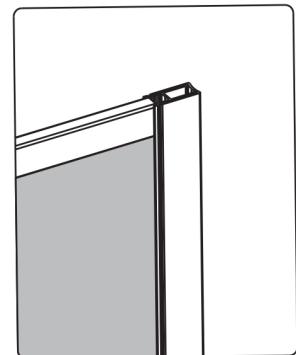



## FRAMED FIXED PANEL

### INSTALLATION INSTRUCTIONS

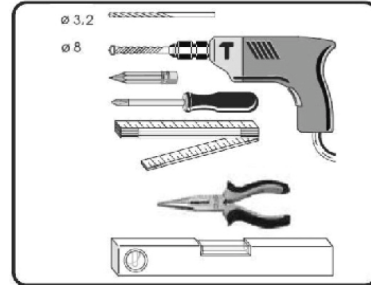
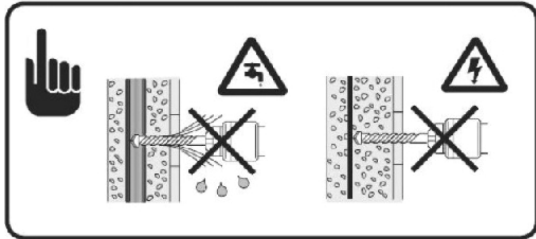

3.

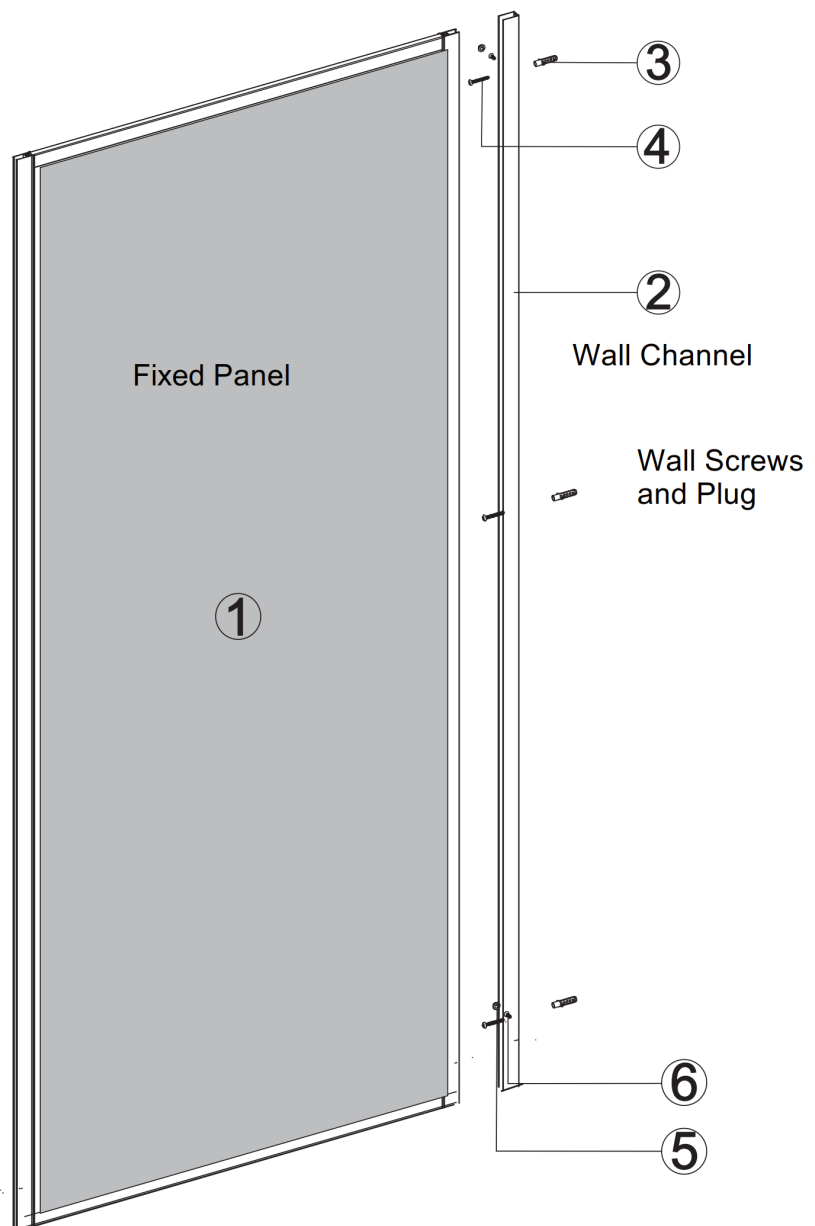

## FRAMED FIXED PANEL

4.

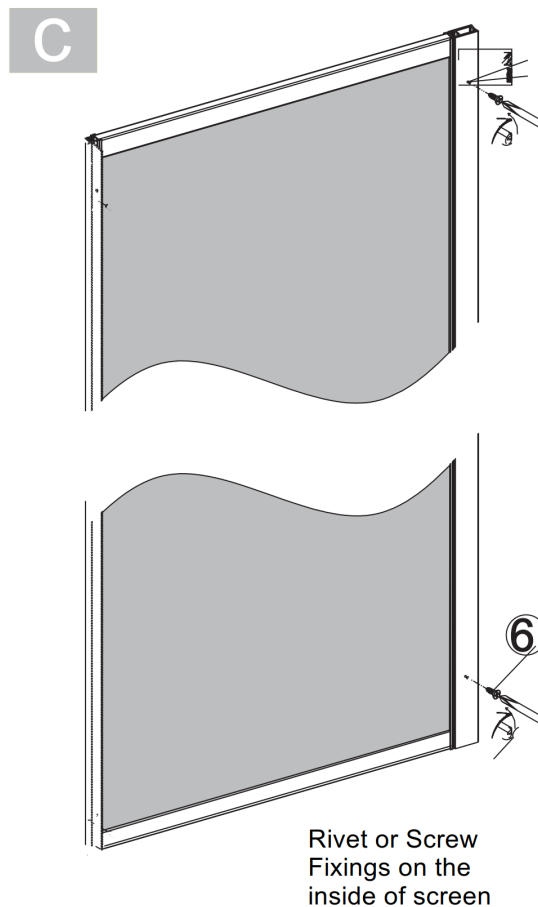
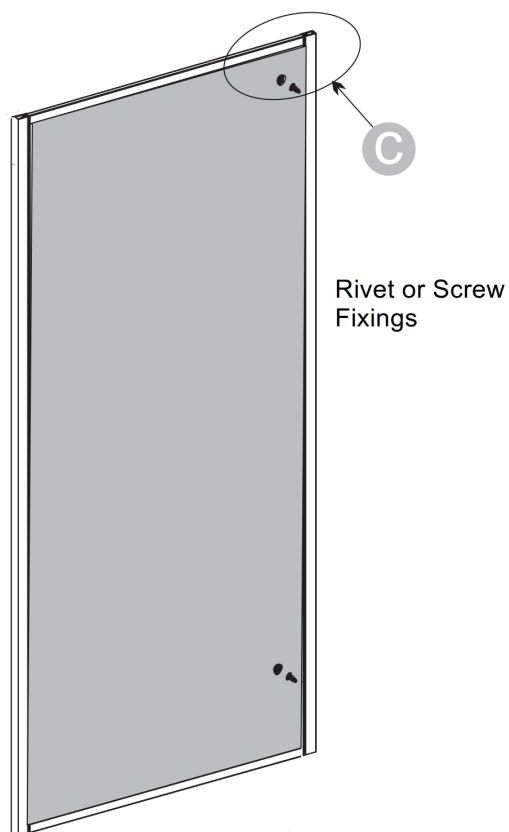

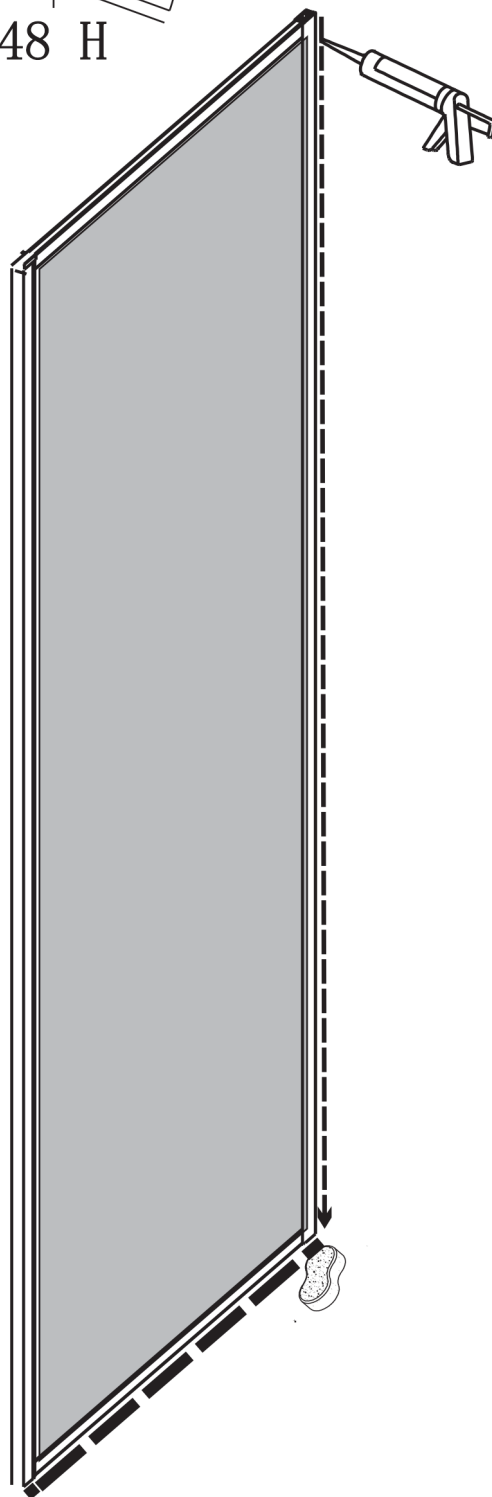
**FRAMED FIXED PANEL**

Silicone  
Down  
both Wall  
Channels  
inside  
and out.  
Only seal  
the bottom  
rails on the  
outside

## **FRAMED FIXED PANEL**

### **DETAILED CLEANING INSTRUCTIONS**

#### **Easy Clean Treated Glass**

After showering we strongly recommend you squeegee the glass to remove water from the surface.

A weekly clean using water and 30% vinegar or a mild detergent is all it takes to remove dirt, soap scum and other contaminants.

Spray the vinegar and water on the glass and wipe with a soft cloth, leave this on the surface for several minutes before rinsing and drying the glass.

#### **Aluminium Frame and Metal Components**

The simplest and most preferred method of cleaning your unit is by washing with clean water and drying with a soft cloth.

Do not use Abrasive powders, steel and Teflon pads or dirty and gritty rags. The anodised coating on the Aluminium is one of the hardest substances known, however, it will be damaged by strong acidic or alkaline solutions. These solutions may dull and discolour the finish.

The most reliable preventative measure to preserve your screen is to wipe the surface dry with a soft cloth after each use.