



In-Ground Cover Box

INSTALLATION GUIDE



IMPORTANT

Henden recommends that this product be installed by a pool or landscape professional.

The lid can hold up to 200kg of direct weight, however, Henden recommends not to walk on it, as it can get hot due to the aluminum material.

WARNING

- > Do not machine compact around the cover box
- > Do not acid wash near the lid

The Henden In-Ground Cover Box is an innovative solution that neatly stores your pool cover beneath the ground.

It complements your new or existing swimming pool area by offering an aesthetically pleasing place to relax and entertain. Made with strong, quality components, the Henden In-Ground Cover Box provides safe, compact storage for your pool cover, protecting it from UV rays and harsh weather. Plus, it's functionally designed for one person operation.

Dimensions

Top view

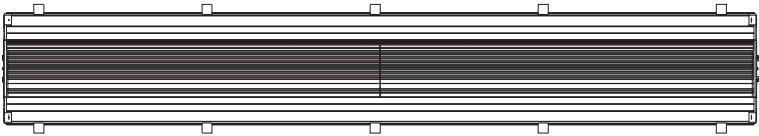

Side view

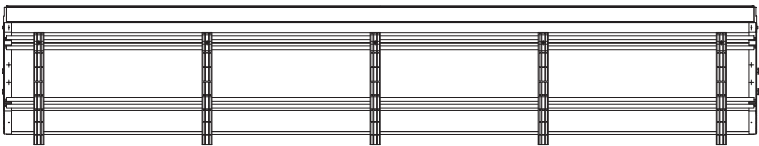

3D view

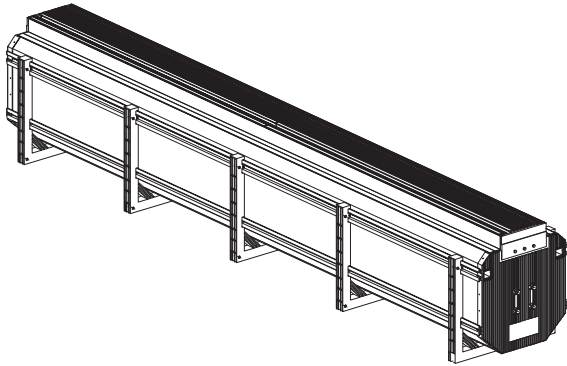

End view

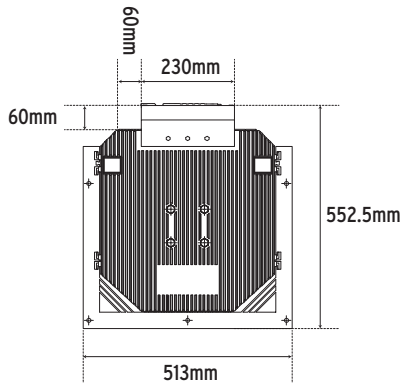

Installing your Henden In-Ground Cover Box

1. Prior to digging, it is important that the headers have been installed. Headers are the coping or cap on the edge of the swimming pool. Headers determine the positioning or placement of the cover box.

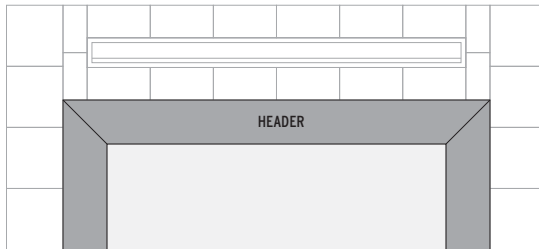

2. Dig and check that all pipes and cables are not in the way of where the cover box will be installed. This should be specified to the pool builder prior to construction of your pool.

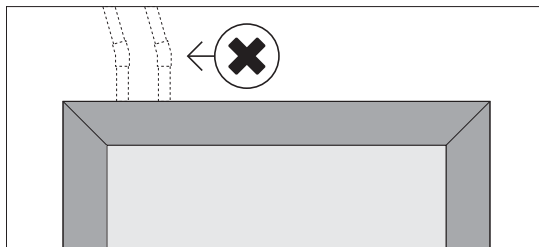

3. Measure the width of pool and allow 150mm to 200mm on either side so that the pool cover can retract on the roller without getting tangled. As a guide, measure 300mm to 400mm (or the width of the pavers that would go in between) from the header to the lid.

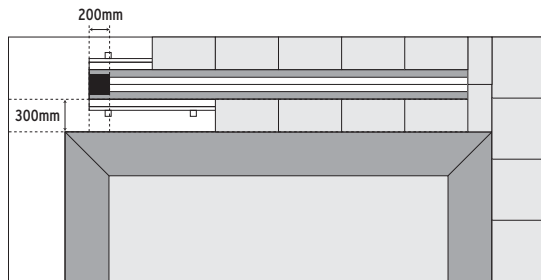

4. Dig a hole that is approximately
- > 600mm deep
 - > 600mm wide
 - > Add 200mm to the length of the cover box

This is so that the cover box has enough room to be moved and adjusted if required.

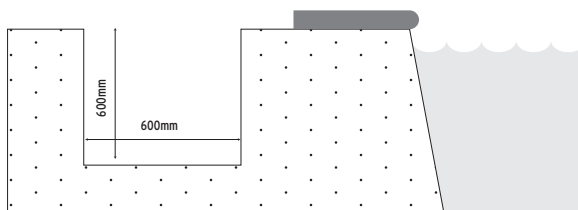

Installing your Henden In-Ground Cover Box

5. Place the cover box into the hole ensuring the lid opens in the correct direction. Also check that the lid height is level with the finished floor level and the cover box is parallel to the pool headers.

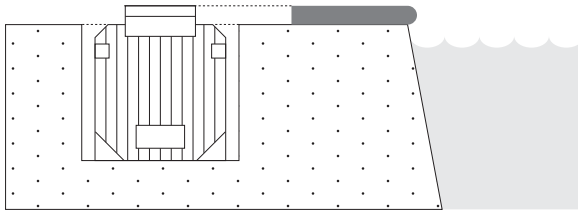

6. Back fill both ends of the cover box approximately 100mm deep. Using a hose, water both ends to ensure compaction. Double check all measurements and levels to ensure the roller box has not moved.

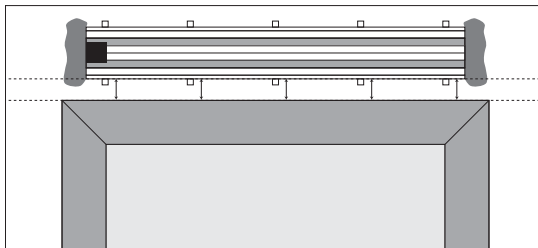

-
7. Use rapid set concrete and pour down the braces to help lock the cover box into position. Then proceed to back fill to complete the installation.

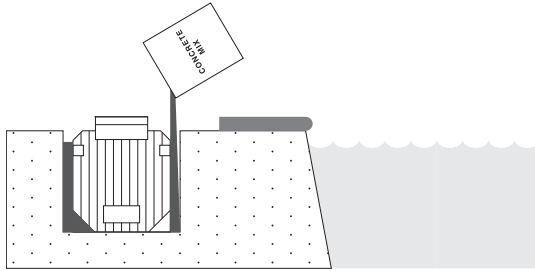

-
8. Ensure all sand and debris is removed from the lid and cover it to protect it.

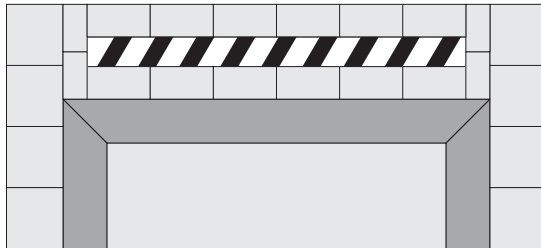

-
9. If the cover is cut to size, open the lid, extend the straps and hook it up to the eyelets.

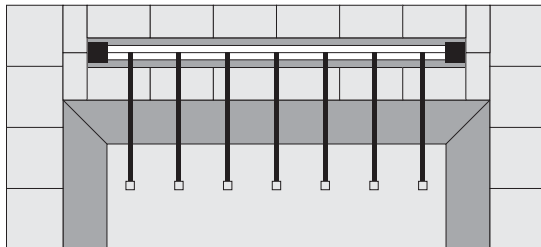

Warranty Information

Your Henden In-Ground Cover Box is covered against manufacturer defects for a total of 5 years on the structure, 3 years on the gear box and 1 year on the outer lid and hinge, cover straps and clips, from the original date of purchase.

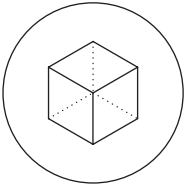

5 years
Structure

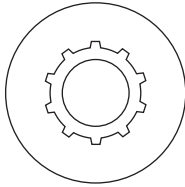

3 years
Gear box

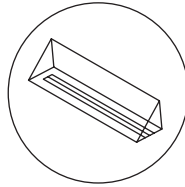

1 year
Outer lid and
hinge

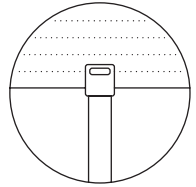

1 year
Cover straps
and clips

Technical and After Sales Support

Should you require technical or after sales support for your Henden In-Ground Cover Box, contact your nearest Reece Irrigation & Pools branch. Visit reece.com.au/storefinder for a complete list of Reece Irrigation & Pools branches.

