

METHVEN

SATINJET ESCAPE MKII

HAND SHOWER WITH WALL BRACKET

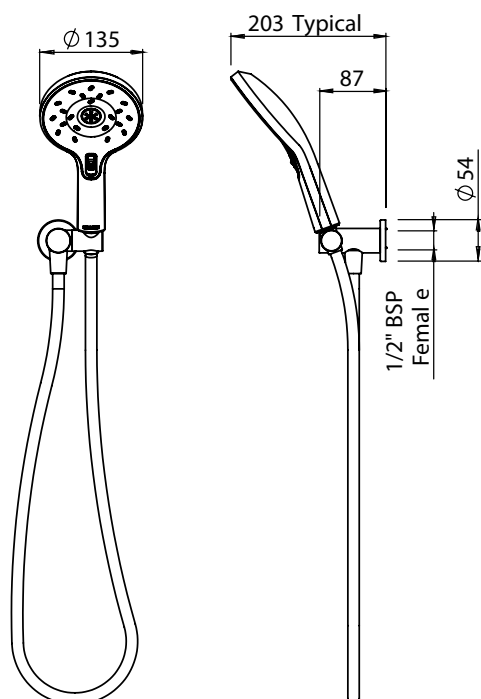

SPECIFICATIONS

Recommended Use	Domestic, hotel and commercial
Colour	Chrome with satin chrome face Chrome with white face
Pressure Rating	Suitable for high pressure applications and has been WELS certified to the following: Minimum operating pressure 150kPa Maximum operating pressure 500kPa
Temperature Rating	Maximum continuous working temperature 70°C (recommended 38°C - 42°C) Minimum 1°C
Suitable Hot Water Units	Storage Tank: Yes Continuous Flow: Yes Gravity Feed: Not recommended
WELS	Stars: 3 Flow rate: 9L/min
Standards	AS/NZS 3662
Spray Patterns	Standard Satinjet; Massage



To see the full METHVEN range at Reece go to www.reece.com.au/bathrooms

CLEANING RECOMMENDATIONS

This bathroom product should not be cleaned with abrasive materials eg. steel wool/scourers. Do not use any corrosive or abrasive cleaning agents containing acids or scouring agents. Bleaches can also discolour products and therefore should not be used. Damage caused by any improper treatment is not covered by the product warranty- refer to Warranty Conditions on the last page.

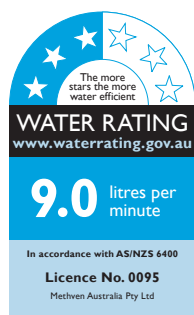

Disclaimer: Products in this specification manual must by regulation be installed by licensed and registered trade people. The manufacturer/distributor reserves the right to vary specifications or delete models from their range without prior notification. Dimensions are nominal measurements only. Dimensions and set-outs listed are correct at time of publication however the manufacturer/distributor takes no responsibility for printing errors.

Tech Page Version 1

METHVEN







reece

METHVEN

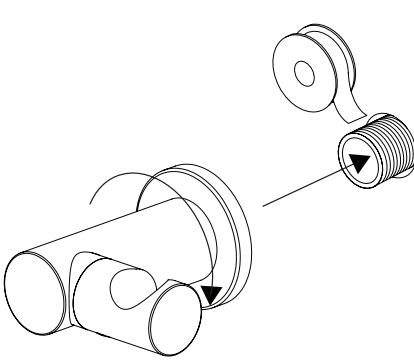
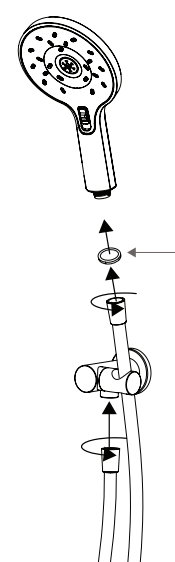
SATINJET ESCAPE MKII

HAND SHOWER WITH WALL BRACKET

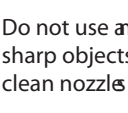
INSTALLATION INSTRUCTIONS

<p>1.</p>  <p>Apply plumbing tape to pipe. Screw wall outlet bracket onto 1/2" nipple pipe ensuring it ends up in the correct position</p>	<p>2.</p>  <p>Flat Hose Washer</p> <p>Insert the flat hose washer into the new hose before screwing into the handset</p>
<h4>CLEANING</h4> <p>Water contains lime which remains on the surface after the water has evaporated. These lime deposits can be prevented from forming by wiping immediately after use.</p> <p>To clean the chrome-plated surface use a soft cloth, soap and warm water. Never use cleaning agents that contain a corrosive acid or a scouring additive.</p> <div style="display: flex; align-items: center;"> <div style="margin-right: 20px;">   </div> <div style="margin-right: 20px;">  </div> <div style="margin-right: 20px;">  </div> <div style="text-align: center;"> <p>Do not use any sharp objects to clean nozzles</p>  </div> </div>	

METHVEN

SATINJET ESCAPE MKII HAND SHOWER WITH WALL BRACKET



REECE PRODUCT QUALITY GUARANTEE

You have purchased a quality product from Reece Pty Ltd ABN 84 004 097 090 ("Reece"). This product is covered by a Lifetime replacement product warranty, including spare parts, and a 12 month warranty covering labour.

LIFETIME YEAR WARRANTY – DOMESTIC USE

This warranty covers faults in the product construction, material and assembly. Products which are, found upon inspection by an authorised Reece representative, to be defective in construction, material or assembly, will be repaired or exchanged with an equivalent product free of charge. Replaced items become Reece's property.

All replacement products will be available for collection without charge to the customer at the nearest Reece branch to the customer's location, or elsewhere as agreed between the customer and Reece.

Labour and Spare Parts

The labour for the replacement of products and spare parts to which this warranty applies will be supplied by Reece or relevant supplier using licensed plumbers engaged by Reece or relevant supplier within 1 year from the date of purchase.

Spare parts found upon inspection by an authorised Reece representative to be defective in construction, material or assembly, will be replaced free of charge for the life of the product.

Warranty Conditions

This warranty will apply only under all of the following conditions:

- The item has been installed by a licensed plumber
- The item has been installed for and subjected to domestic residential use only
- Failure is due to a fault in the manufacture of the product
- Proof of purchase (including the date of purchase) is provided
- The installation of the product is in accordance with the instructions provided

This warranty does not cover products purchased as an ex-display without being fully checked and tested for sale by the manufacturer.

This warranty does not include faults caused by:

- Unsuitable or improper use
- Incorrect installation or installation not in accordance with the instructions provided
- Installation or part installation by the purchaser or any person other than a LICENSED PLUMBER
- Normal wear and tear

- Inadequate or complete lack of maintenance
- Chemical, electrochemical or electrical influences
- Harsh detergents or abrasive cleaners used on product finishes

1 YEAR WARRANTY – COMMERCIAL USE

'Commercial' use is all use other than for normal domestic residential purposes, including use in non-business places as in public buildings, schools, sports centres and in establishments that contain private bathrooms with high frequency of use by many individuals, such as hotels, motels, retirement villages and hospitals.

The Commercial warranty covers this product against manufacturing faults in the construction, material and assembly of both the finished products and any spare parts for a period of 1 year from the date of purchase. Products and spare parts which are found upon inspection by an authorised Reece representative to be defective in construction, material or assembly will be repaired or exchanged free of charge. Replaced items become Reece's property. The labour for the replacement of products and spare parts to which this warranty applies will be supplied by Reece or relevant supplier using licensed plumbers engaged by Reece or relevant supplier. The Warranty Conditions and exclusions which apply to the domestic use warranty also apply to this commercial warranty.

EXCLUSIONS

To the fullest extent permitted by law, Reece excludes all liability for damage or injury to any person, damage to any property, and any indirect consequential or other loss or damage.

CLAIM PROCEDURE

For all warranty queries customers are to contact the branch where the product was purchased. These details can be found on your purchase invoice.

Our goods come with guarantees that cannot be excluded under the Australian Consumer Law. You are entitled to a replacement or refund for a major failure and for compensation for any other reasonably foreseeable loss or damage. You are also entitled to have the goods repaired or replaced if the goods fail to be of acceptable quality and the failure does not amount to a major failure.