

ROCA

L20 SHOWER MIXER

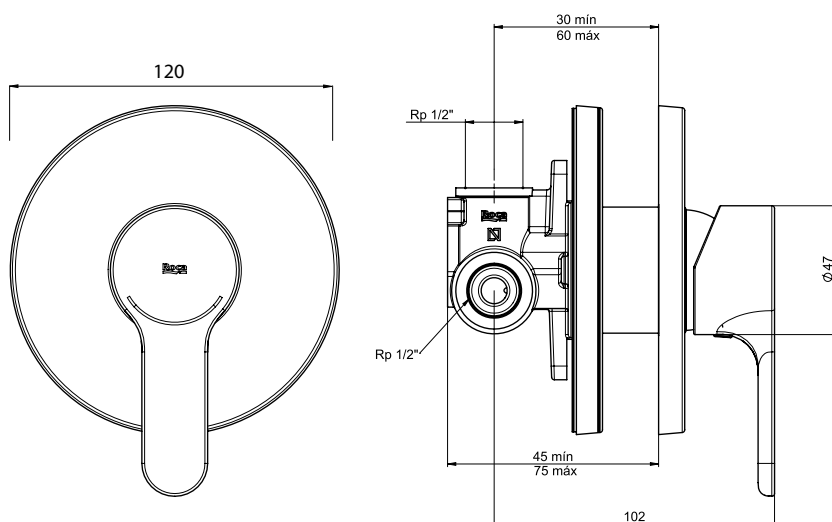

SPECIFICATIONS

Recommended use	Domestic, hotel and commercial
Colour availability	Chrome
Pressure rating	Maximum continuous operating pressure 1000kPa. For best performance and longer life we recommend 150-500kPa. Hot and cold water inlet pressure should be equal.
Temperature rating	Maximum continuous working temperature 80°C
Suitable Hot Water Units	Storage tank: Yes Continuous Flow: Yes Gravity Feed: Not suitable
Standards	AS/NZS 3718



To see the complete Roca range go to www.reece.com.au/bathrooms

CLEANING RECOMMENDATIONS

We recommend the use of soapy water or approved cleaners. This product should not be cleaned with abrasive materials. Damage caused by any improper treatment is not covered by the product warranty - refer to Warranty Page for full Terms and Conditions.













ROCA

L20 SHOWER MIXER

INSTALLATION INSTRUCTIONS

Important Note

Mixer must be installed to the requirements of AS/NZS 3500 by a qualified plumber. Your mixer comes to you already factory assembled and tested. We do not recommend the dismantling of any internal part of the mixer. The mixers are factory tested and sealed so as to give the best performance.

 P 	P kPa	 MAX 1000	
 P 	P kPa	MIN 100  500 MAX	300   200
  T	°C	 -80 MAX.	 65 45 

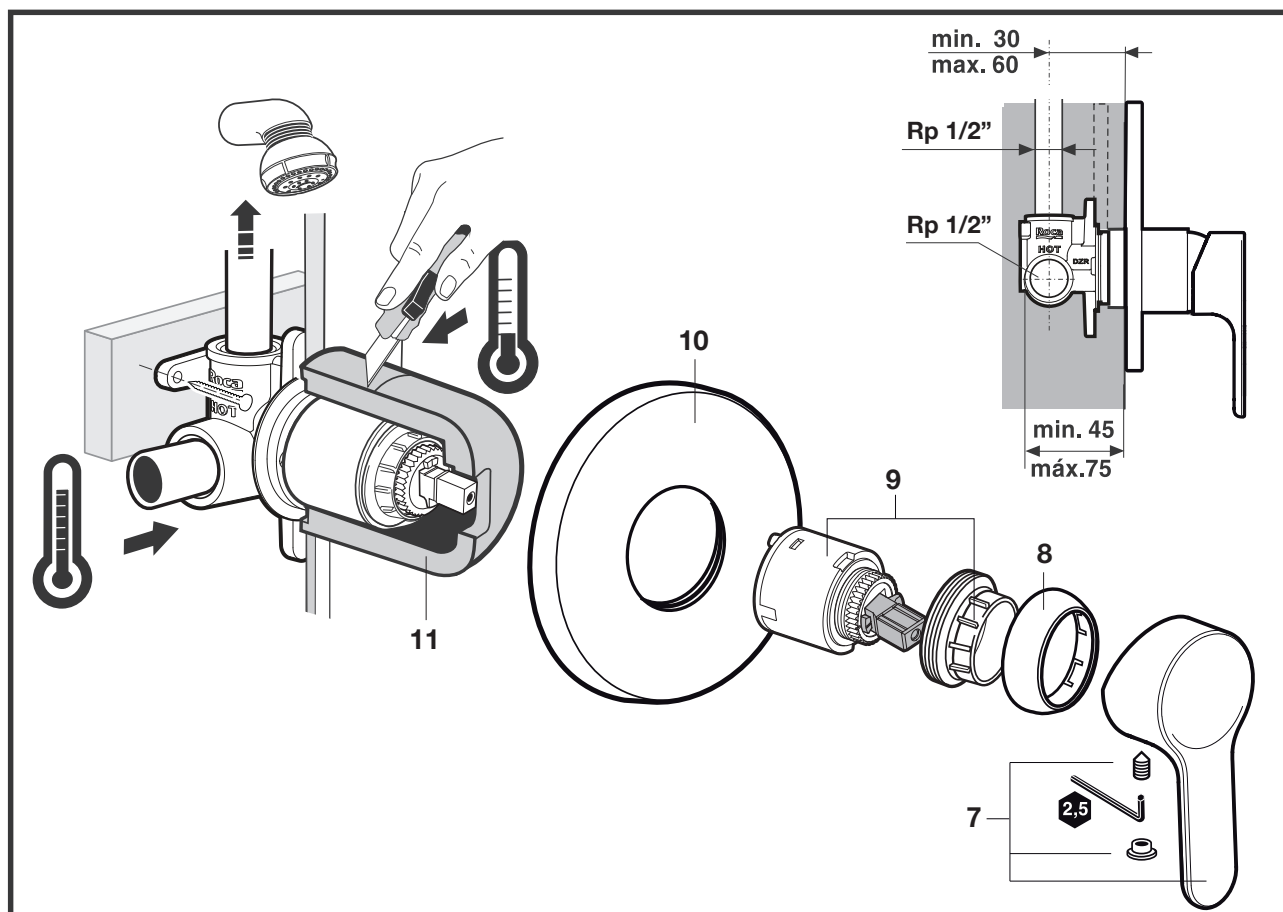

Plumbers, please ensure a copy of the installation instructions is left with the end user for future reference

ROCA L20 SHOWER MIXER

CLEANING INSTRUCTIONS

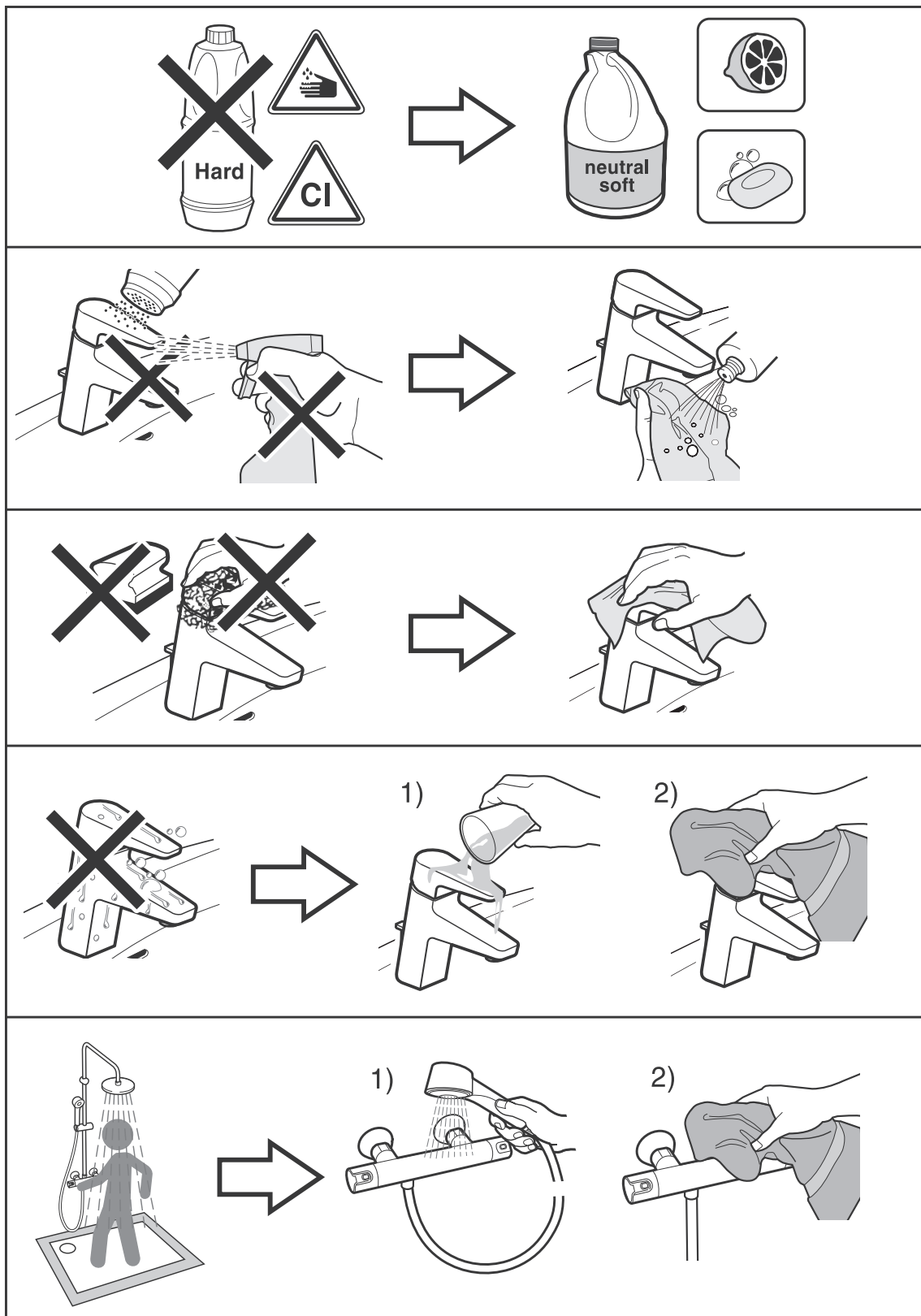

Plumbers, please ensure a copy of the installation instructions is left with the end user for future reference