

# UniGUARD™

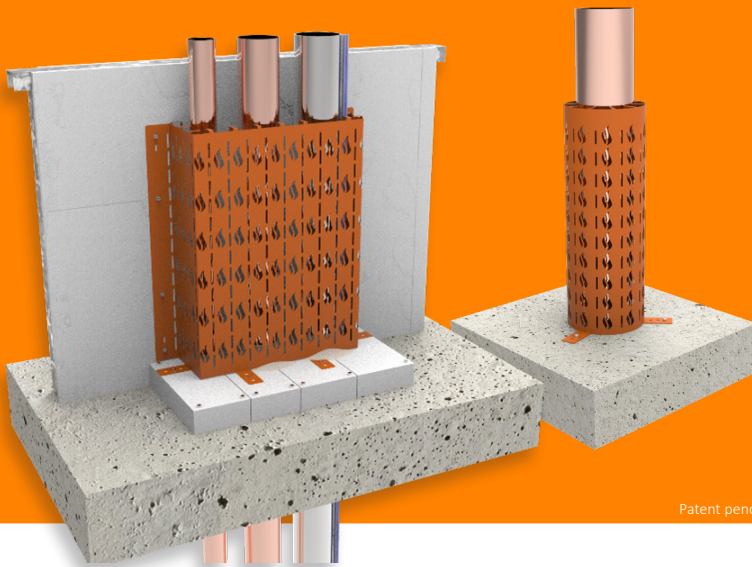

Patent pending

Trafalgar Fire has developed an easier and quicker installation option for wrapping large metal pipes.

The UniGUARD™ system is tested for use around large metal pipe penetrations, where large amounts of insulation wrap are not practical to prevent heat transfer. The UniGUARD™ is a flat packed, easy to transport, insulation guard which gives an easy to install solution for fire stopping.

**NCC 2022 ready!**

Click to Watch Installation Video



## Key Features



- Flat packed for easy shipping, transport and storage
- Simple and quick to install
- More cost effective than wrap systems for large pipes
- FRL's up to-/120/120 for large metal pipes (DN150)
- Equivalent heat transfer performance than wrap systems
- Quicker solution for large pipes that would typically need long lengths of insulation wrap (TWRAP™)
- Tested to AS1530.4-2014

## Applications



- Metal pipe floor penetrations
- Multiple metal pipe penetrations hard against a riser wall
- Steel and copper pipes
- Tested for use in concrete slabs, FyreBATT™ and FyreBOARD Maxilite® substrates



## TRADES



# Table of Contents

Section		Page
	Benefits	3
	Fire Resistance Level	4
FRL Tables	Concrete Floor Slabs	5
	Concrete Floor Slab- Three Sided Applications	6
	Installation Manual	7-9
	System Ranges	10
	FAQ	11
	Technical Drawings	12-13

# UniGUARD™

## What is UniGUARD™?

The UniGUARD™ is a new insulation guard that does away with excessively long lengths of wrap products that are typically needed for large pipes.

UniGUARD™ is shipped flat for easy storage and transportation. Then simply folded around the pipes on site for installation.

## Applications

Suitable for DN150 copper and steel pipes, it is only 600mm tall and a top-side only installation. With multiple use configurations, the UniGUARD™ is a single product with multiple uses dependent on the installation method used.

The UniGUARD™ can wrap around a single pipe as a free-standing guard, bolted to the floor through the pre-formed fixing tabs at the base.

Alternatively, for multiple services against a wall the UniGUARD™ can bend to a three sided guard. This is ideal for tight riser shafts with services tightly packed together with low access.

Please note that the UniGUARD™ achieves the insulation part of the FRL only, so the pipe must first be sealed with FyreFLEX® Sealant as it passes through the concrete floor slab (or through FyreBATT™ or FyreBOARD Maxilite™ floor penetration systems).



# UniGUARD

## Fire Rating – How is fire performance measured?

An FRL (fire resistance level) is a handy way of summarising the performance of a building element. It consists of 3 numbers, all given in minutes:

### FRL 240/240/240

(example)



#### Structural Adequacy

The ability of the building element to support the weight of adjacent building elements.

ie: a brick wall supporting a concrete floor slab above.



#### Integrity

The ability of an element to prevent the passage of flames and hot gasses.

ie: a plasterboard wall remaining intact and not allowing holes to form.

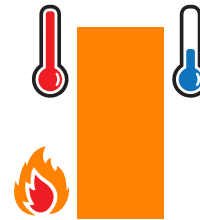

#### Insulation

The ability of an element to resist heat transfer from the exposed face to the unexposed face.

ie: a bundle of cables remaining below a set temperature limit on the unexposed side of the wall penetration system.

*Penetrations are not required to have a Structural Adequacy rating and is usually expressed as a dash. For example, a penetration through a 4-hour load bearing wall would be written as -/240/240.*

## Integrity

The metal pipes must first be sealed with FyreFLEX® sealant at the floor penetration to prevent the fire from physically spreading through the penetration before the UniGUARD™ can be installed. UniGUARD™ has also been tested with FyreBATT™ and FyreBOARD Maxilite® floor penetration systems.

## Insulation (Temperature Rise)

Heat transfer via conduction (or heat rise) will occur through the conductive parts of any penetration system. To limit the heat-rise through penetration systems, the UniGUARD™ allows for an air gap to the service, stopping contact of surrounding building elements with the service. This allows the UniGUARD™ system to achieve up to 2 hours of insulation performance.

## FRL Approvals Tables

### Concrete Floor Slab

Core-hole to suit pipe size

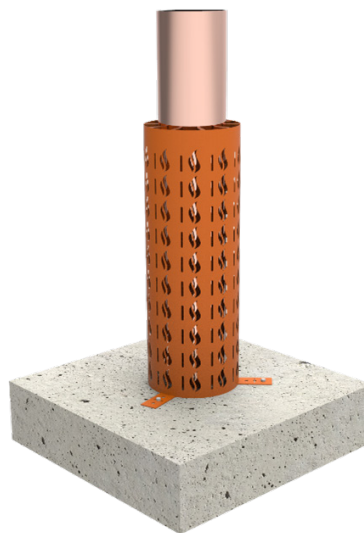

Service Type	Hole Size	FyreFLEX® Sealant	FRL	Test Reference
DN150 Copper Pipe	170mm (core hole)	50mm fill depth into the slab, finished with a 30x30mm fillet on the top side	-/90/90 -/120/120 -/180/120	FRT 200257
NB150 Steel Pipe				
DN100 Copper Pipe	Pending			

FRL TABLES - Concrete Floor Slab

### Concrete Floor Slab

#### Openings up to 800 x 600mm

Oversized openings in concrete slabs can be closed-down with FyreBATT penetration systems, with the UniGUARD™ has been tested and approved.

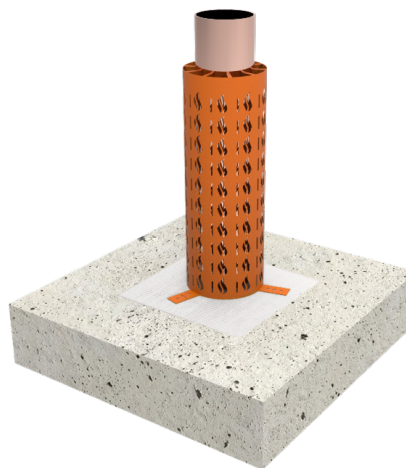

Service Type	Hole Size	FyreFLEX® Sealant	FRL	Test Reference
DN150 Copper Pipe	180mm (core hole in the Fyre-BATT))	Filled to full depth of FyreBATT™ with a 30x30mm fillet	-/90/90 -/120/120 -/180/180	FRT 200385
NB150 Steel Pipe				
DN100 Copper Pipe	Pending			

# FRL Approvals Tables

## Concrete Floor Slab

Three sided applications with FyreBOARD Maxilite® Openings up to 1800 x 1000mm

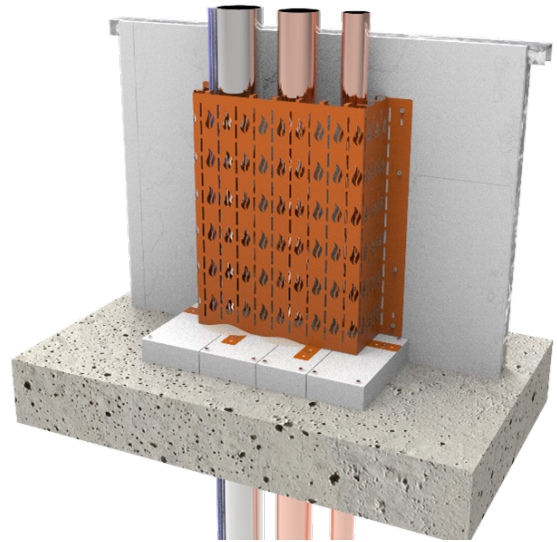

Service Type	Maximum Hole Size (cut into FyreBOARD Maxilite®)	FyreFLEX® Sealant	FRL	Test Reference
DN100 Copper Pipe	135mm	Filled to the full depth of the FyreBOARD Maxilite® finished with a 50x50mm fillet on the top side	-/120/90	FRT 200385
DN65 Copper Pipe	85mm			
NB100 Steel Pipe	135mm			
1 x 3C&E Power	Cable must be in the same hole as above steel pipe			
1 x Fire Alarm Cable				

FRL TABLES - Concrete 3 Sided Applications

The floor penetration system was tested against a non-fire rated plasterboard wall, simulating a non-fire rated riser shaft.

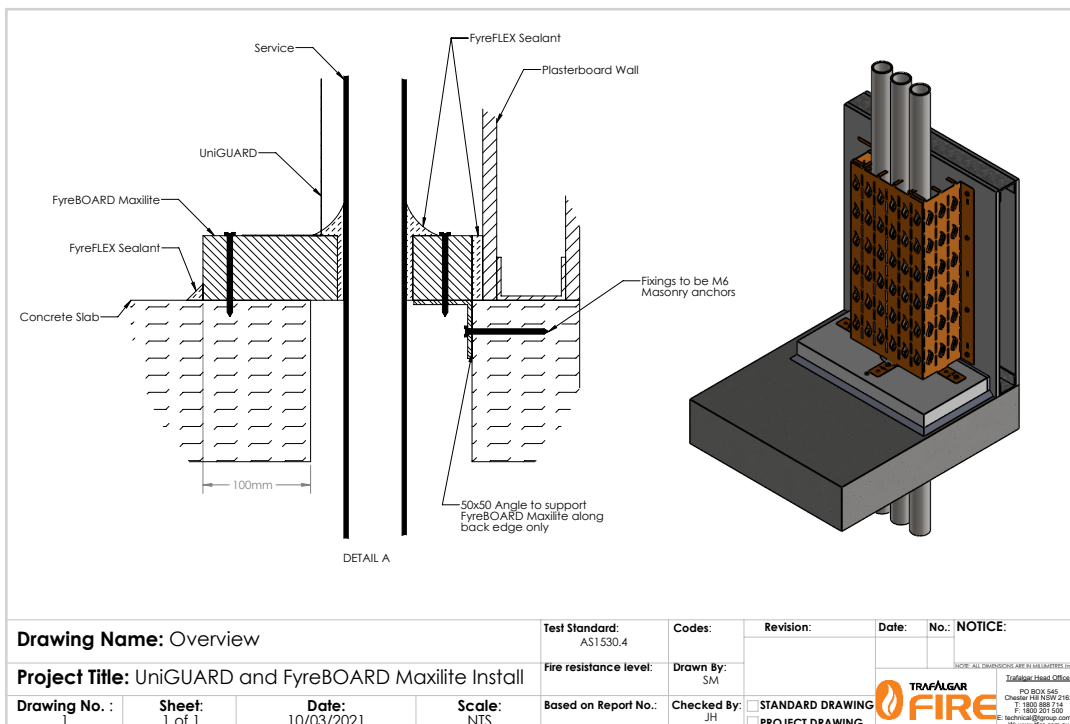

## INSTALLATION

### Core hole penetrations (hole cut to size in a concrete slab)

Click to Watch Installation Video



#### Run Service



Form the correct sized hole per the approval's tables above, then the service can be run through the concrete slab.

#### Seal



Apply FyreFLEX® Sealant to a depth of 50mm into the slab, then finish with a 30x30mm fillet on the top side. Backing rod may be used to set the correct depth.

*If a larger opening is present, FyreBATT™ can be cut to size to suit the opening and friction fit in. The service can then be installed into the batts to the specification of the approval's tables.*

#### Prepare UniGUARD™

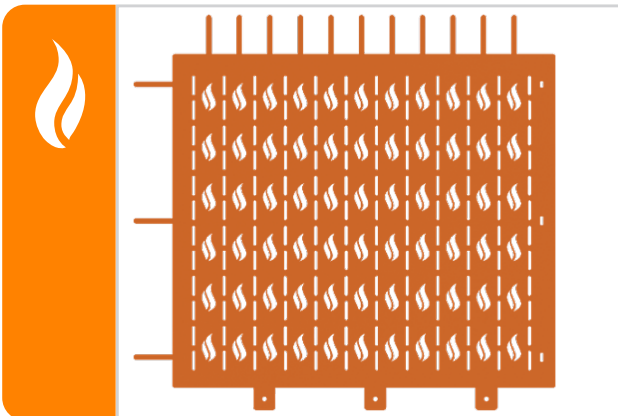

The UniGUARD™ comes flat packed and can be simply bent into for a circle using the bend reliefs across the face of the guard.

Bend out the feet to 90 degrees, then wrap the UniGUARD™ around the pipe to form a neat circle.

#### Install UniGUARD™



Slide the 3x fixing tabs into the preformed slots, and bend them over to hold the UniGUARD™ together in shape.

Using the 3x feet tabs, fix the UniGUARD™ to the concrete floor with M6 masonry anchors (M6x50mm Dynabolts for example) or 90mm pigtail screws for FyreBATT installations.

Bend over top fingers ensuring a 30mm air gap around the pipe.

# INSTALLATION

## Larger openings against a wall

Click to Watch Installation Video



### Prepare Opening



Run the services through a large opening, ensuring 50mm of separation between each service. Install a 50x50mm steel angle along the back edge to support the FyreBOARD Maxilite®.

### Fix FyreBOARD Maxilite®



The 60mm FyreBOARD Maxilite® can be pre-cut and joined around the service. Ensure the board overlaps the slab by 100mm and fix board to the slab with M6x100mm masonry anchors. Also fix the FyreBOARD Maxilite® down to the rear steel angle with 10g x 100mm plasterboard screws at max 400mm centers.

*The UniGUARD™ is made using thin sheet metal, making it easy to bend and manipulate when installing from its flat packed state.*

### Apply Sealant



Apply FyreFLEX® Sealant to the full depth of the FyreBOARD Maxilite®, then finish with a 50x50mm fillet.

A small bead of FyreFLEX® should also be installed around the perimeter of the FyreBOARD Maxilite®.

### Install UniGUARD™

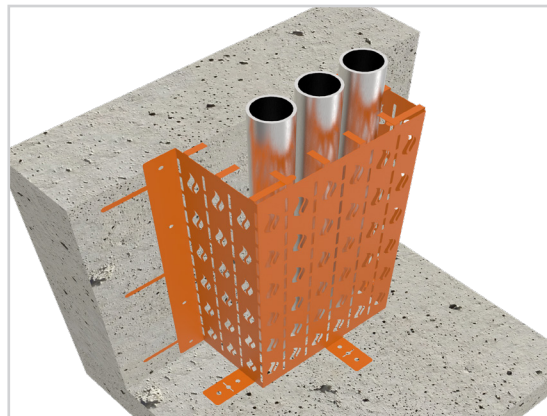

Four bends are required to form the three-sided UniGUARD™ configuration.

The side edges need to bend back to fix to the wall through the pre-formed fixing holes.

Bend over top fingers ensuring a 30mm air gap around the pipe.



## TWRAP™ Vs UniGUARD™



The UniGUARD™ is an alternate method to wrapping services with our TWRAP™. It might be preferred to TWRAP™ for larger services which typically need a large amount of Wrap. For example, for a DN150 copper pipe in a concrete slab treated with FyreFLEX®, the usual amount of TWRAP™ required is 850mm to achieve-/120/120. The same pipe can achieve-/180/120 with the UniGUARD™, which is only 600mm tall. On the other hand, smaller copper pipes may only need 300mm of TWRAP™ so the UniGUARD™ would not be suitable.

## Approved Fixings

	Fixed into	Approved Fixing
UniGUARD™	Concrete Floor Slab	M6 Masonry Anchors
	Walls (3 sided applications)	Screws appropriate for the wall type (plasterboard screws, masonry anchors etc.)
	FyreBOARD Maxilite®	8g x 50mm plasterboard screws
	FyreBATT™	10g x 90mm Pig tail screw

## UniGUARD™

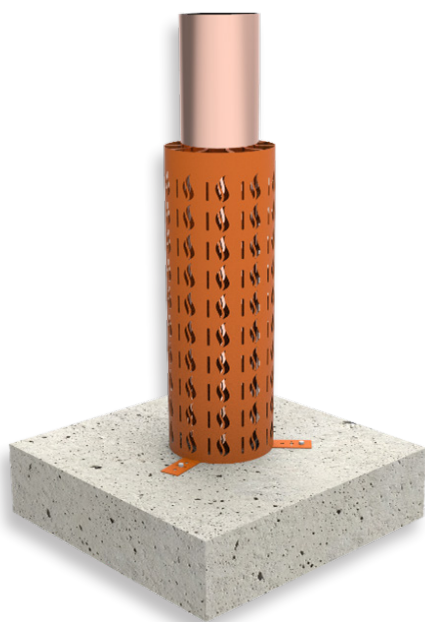

Item Number	Description	Min Order Qty
UniGUARD150	600 x 690 x 0.6mm Powder Coated Orange	1

## UniGUARD Accessories

Item Number	Description	Min Order Qty	Pallet QTY
FyreFLEX 600W FyreFLEX 600G	FyreFLEX Sealant Sausage 600ml White or Grey	18	810
FyreBATT 60mm	Coated mineral fibre Batt 60x600x1000	4	N/A
FyreBOARD Maxilite L 60	2040 x 1220 x 60mm (Blue)	1	17
FyreBOARD Maxilite Half L 60	1020 x 1220 x 60mm (Blue)	1	34
FyreBOARD Maxilite 60	1525 x 1000 x 60mm (White)	1	15
FyreBOARD Maxilite Half 60	760 x 1000 x 60mm (White)	1	30

# FAQ?

**Q Do I need to apply TWRAP™ to these pipes?**

**A** No, UniGUARD™ is used as an alternate to traditional wrap products..

**Q Do I need to apply sealant to the services?**

**A** Yes, the services still need to be sealed with FyreFLEX® Sealant through the slab/FyreBATT/FyreBOARD Maxilite®.

**Q Can UniGUARD™ be used for other sized pipes?**

**A** Not at the moment, however further testing is underway to increase the approvals for this product.

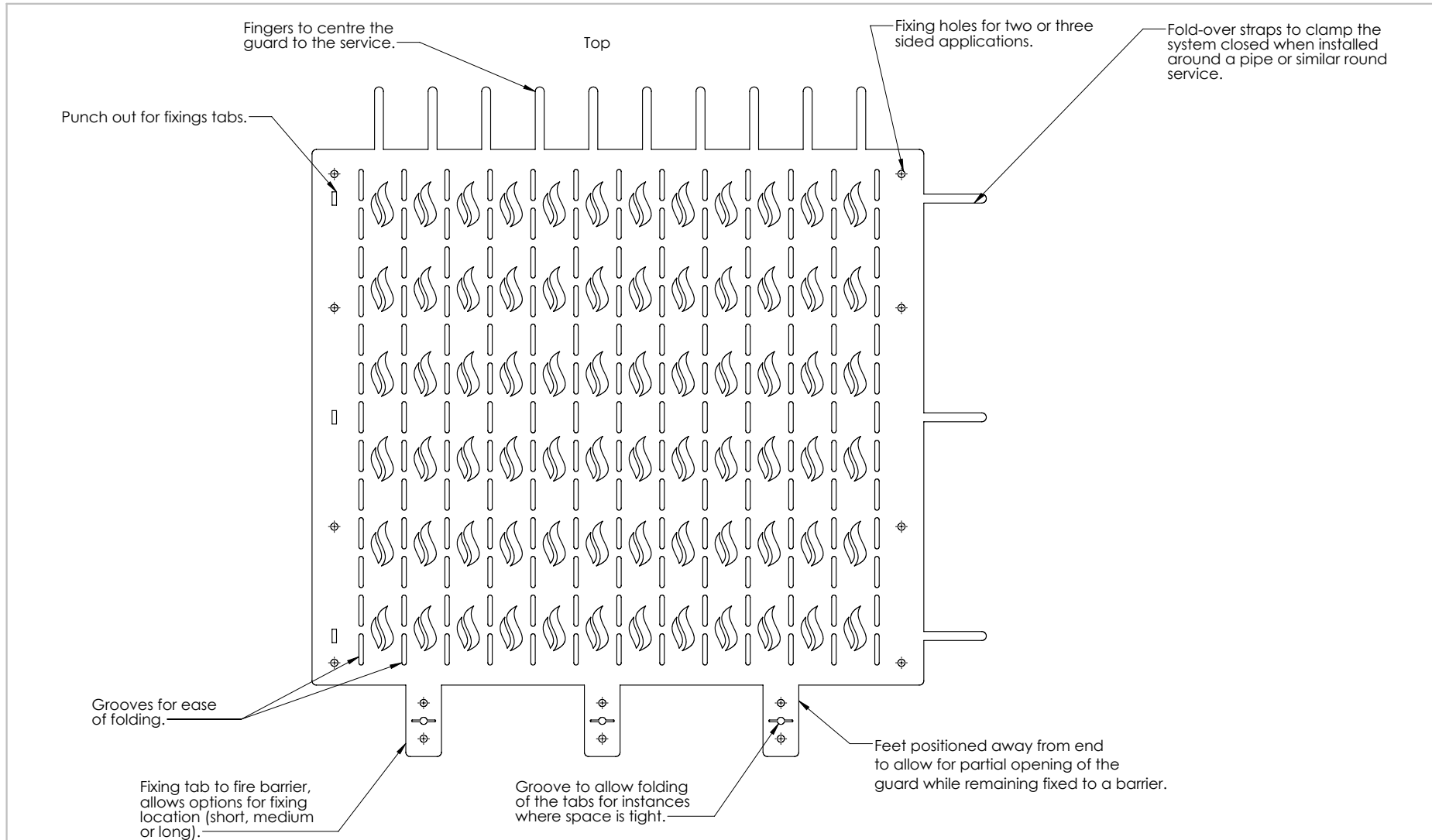

<b>Drawing Name:</b> Overview				<b>Test Standard:</b> AS1530.4	<b>Codes:</b>	<b>Revision:</b>	<b>Date:</b>	<b>No.:</b>	<b>NOTICE:</b>
<b>Project Title:</b> Uni-Guard				<b>Fire resistance level:</b>	<b>Drawn By:</b> SM	<small>NOTE: ALL DIMENSIONS ARE IN MILLIMETRES (mm)</small>			
<b>Drawing No. :</b> 1	<b>Sheet:</b> 1 of 2	<b>Date:</b> 18/02/2021	<b>Scale:</b> NTS	<b>Based on Report No.:</b>	<b>Checked By:</b> JR	<input type="checkbox"/> STANDARD DRAWING	 <p><b>TRAFALGAR</b> <b>FIRE</b></p> <p><small>Trafalgar Head Office:</small> PO BOX 545 Chester Hill NSW 2162 T: 1800 888 714 F: 1800 211 500 E: technical@tgroup.com.au W: www.tfire.com.au</p>		
						<input type="checkbox"/> PROJECT DRAWING			

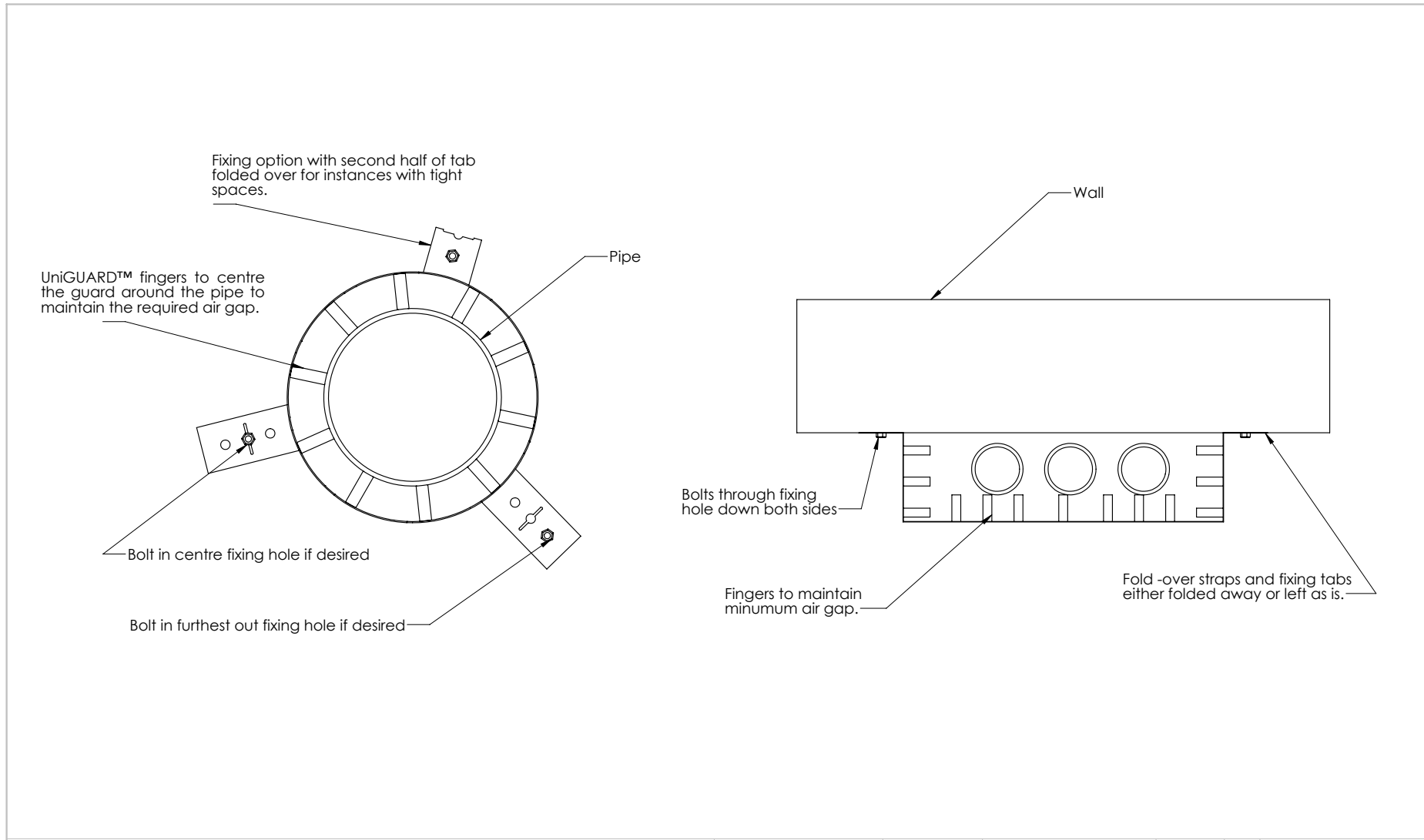

<b>Drawing Name:</b> Installation Configurations				<b>Test Standard:</b> AS1530.4	<b>Codes:</b>	<b>Revision:</b>	<b>Date:</b>	<b>No.:</b>	<b>NOTICE:</b>
<b>Project Title:</b> UniGUARD™				<b>Fire resistance level:</b>	<b>Drawn By:</b> SM	<small>NOTE: ALL DIMENSIONS ARE IN MILLIMETRES (mm)</small>			
<b>Drawing No. :</b> 2	<b>Sheet:</b> 2 of 2	<b>Date:</b> 21/10/2020	<b>Scale:</b> NTS	<b>Based on Report No.:</b>	<b>Checked By:</b> JH	<input type="checkbox"/> STANDARD DRAWING	 <small>Trafalgar Head Office:</small> PO BOX 545 Chester Hill NSW 2162 T: 1800 888 714 F: 1800 201 500 E: technical@tgroup.com.au W: www.tfire.com.au		
						<input type="checkbox"/> PROJECT DRAWING			