

ROTHENBERGER ROGROOVER

Portable roll grooving for steel pipes up to 6"

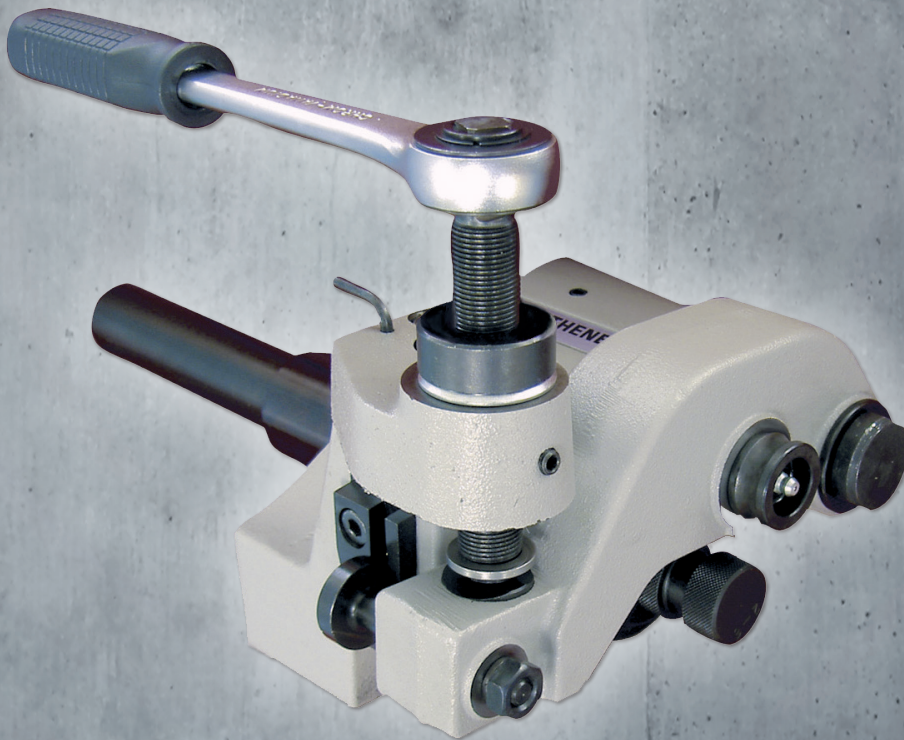

Portable

Designed for one person doing multiple jobs at different sites



Time Saving

Quick and easy to setup, able to be packed up in a few small components



Convenient

Quick connection of pipes where welding isn't allowed

ROLL GROOVING

ROGROOVER

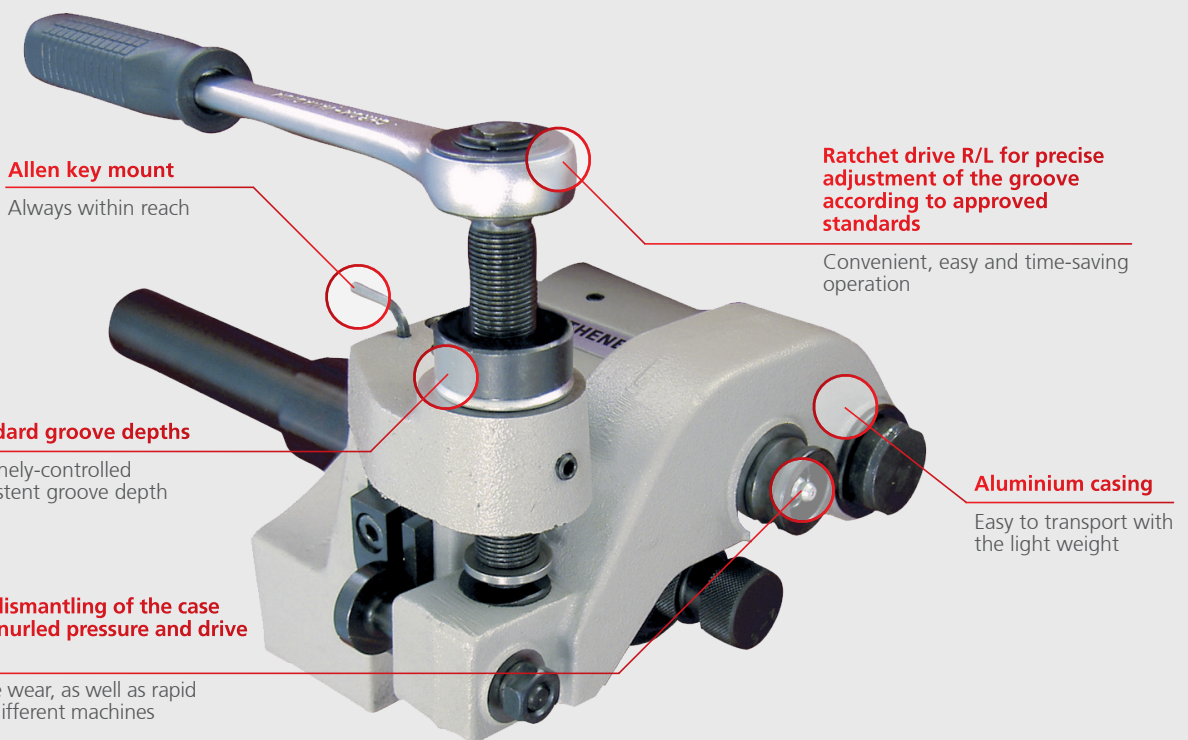

Professional application with threader for the production of grooves



Cost-effective production of grooves



Detailed view

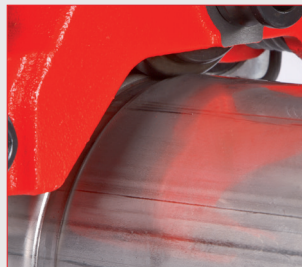

Pipe with grooves



Roll Groover 6"

Portable rolling groover for steel pipes up to Ø 6" (150 mm) for rapid rolling of grooves on standard and thin-walled steel pipes

Suitable for installations, sprinkler systems, larger heading units, industrial use and mining

Application Area

Standard and thin walled steel pipes up to 6".

Lightweight and compact design allows for use with threaders:

- SUPERTRONIC 2000
- SUPERTRONIC 2 SE
- SUPERTRONIC 3 SE
- SUPERTRONIC 4 SE

Key Features

- Quick connection of pipes anywhere where welding isn't allowed
- Long life and little wear
- Easy to transport with the lightweight aluminium casing
- Adjustable and finely-controlled arrester for consistent groove depth
- Convenient, easy and time-saving operation
- Kits available for roll grooving only, or roll grooving and threading up to 2"

A real portability solution for the mobile tradesman:

We recommend the following selections as the ideal mobile grooving and threading setup, for tradesmen doing multiple small or low-volume jobs at different sites, requiring the equipment to be easily relocated and used with just one operator.

Compact for quick and easy setup, and able to be packed up into only a few small components that will easily fit into the back of most work vehicles, without taking up much space.

Variants

Model		 kg
8870922KIT1	FOR ROLL GROOVING	42
8870922KIT2	FOR ROLL GROOVING & THREADING	49

8870922KIT1 includes:
ROGROOVER (no. 8870922), Supertronic 2000 machine only (no. 71250), Die head adaptor (no. 71271), Base plate to suit ST2000 (8870921), Portable work stand (no. 70751)

8870922KIT2 includes:
ROGROOVER (no. 8870922), Supertronic 2000 threading set 1/2" to 2" (no. 71256), Base plate to suit ST2000 (8870921), Portable work stand (no. 70751)

NOTE:

If you only need to roll groove to 6", order 8870922KIT1
If you need to roll groove to 6" and thread (up to 2") order 8870922KIT2

Technical Data

Description	
Working capacity	SCH10 - 2-6" steel pipe
	SCH40 - 2-3" steel pipe
Weight KIT1	42 kg
Weight KIT2	49 kg



ROGROOVER



Work stand



Die head adaptor



Supertronic 2000

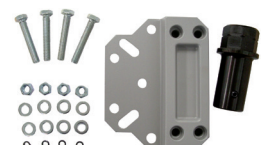

Base plate

THREADING

ST2000

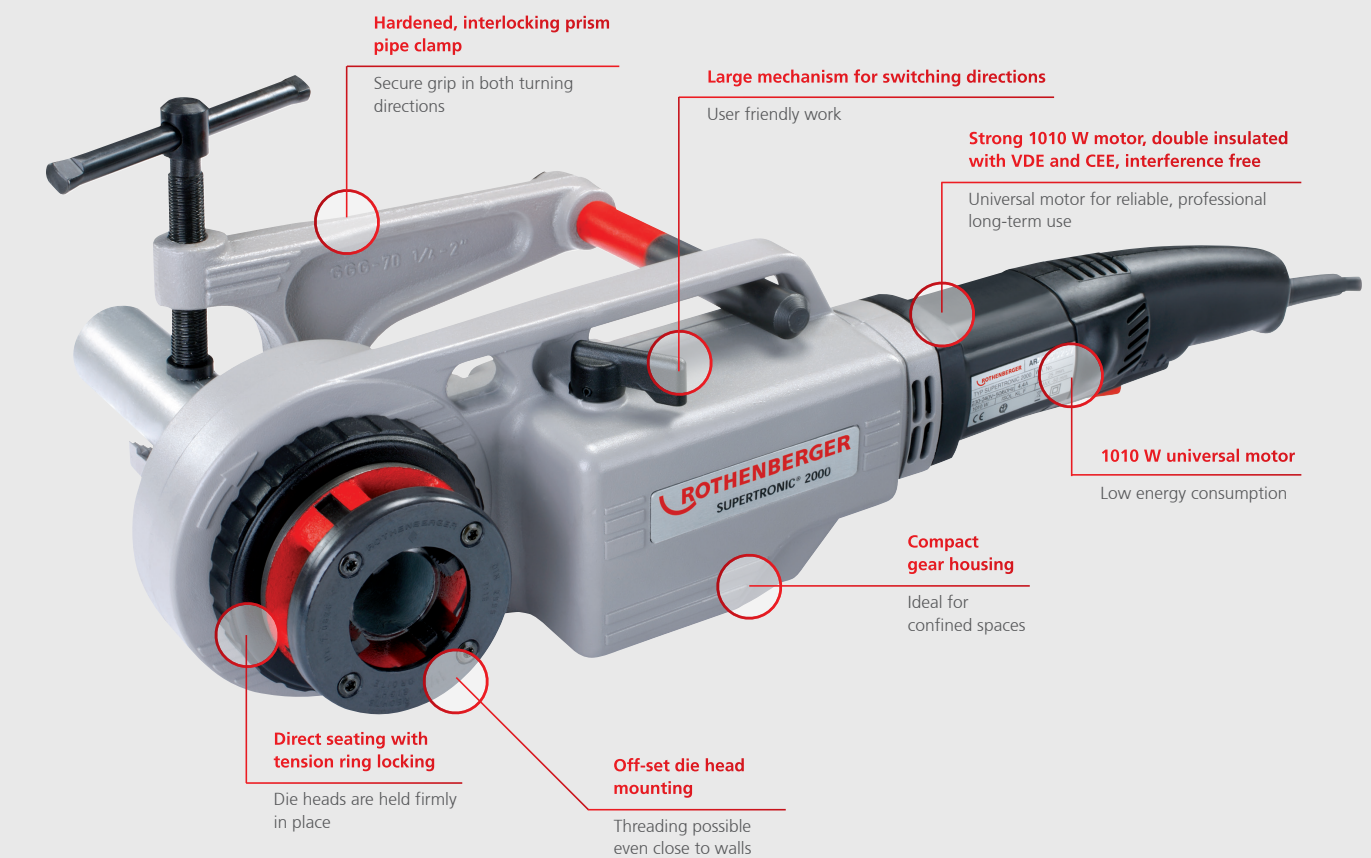

Easy insertion of the die heads



Use with roll grooving tool ROGROOVER



Die head adaptor (No. 71271)



High reduction gears

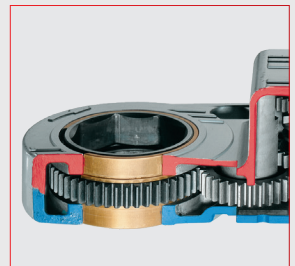

SUPERTRONIC 2000

Power threader 1/4 - 2"

For quick and effortless production of precise and reliable thread connections to approved standards

Application Area

For threading of

BSPT right: 1/4 - 2"

NPT: 1/4 - 2"

High reduction gears with spur wheel teeth, induction tempered, 7 parallel gear shafts, each ball bearing mounted

High, consistent power transmission when fully loaded

Performance:

Strong 1010 watt motor, double insulated with VDE and CEE, interference free for reliable long-term use

Threading speed:

15 - 25 rpm, rapid reverse 60 rpm

(4 x faster reverse with reverse drive)

Maintenance friendly with continuous lubrication

Key Features

- Secure grip in both turning directions with the hardened, interlocking prism pipe clamp
- Die heads are held firmly in place through direct seating with tension ring locking
- Off-set die head mounting allows for threading even close to walls
- Ideal for confined spaces (corners and shafts)
- User-friendly work with the large mechanism for switching directions
- Reliable motor for long-term use

Variants

Model		kg
71256	BSPT R 1/2, 3/4, 1, 1.1/2 & 2"	18
71250	Supertronic 2000 machine only	6.8

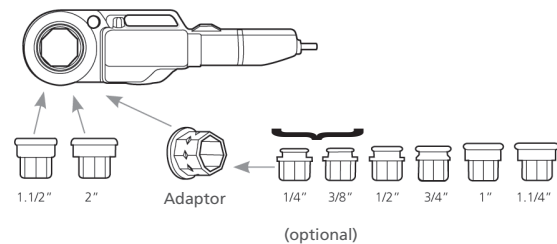

Work in confined spaces



Threading oil No. 65010



+ Further Accessories



Pipe Support Stand
No. 10640



Heavy Duty and Aluminium Pipe Wrenches
Sizes 6" to 60" (HD) 10" to 60" (AL)

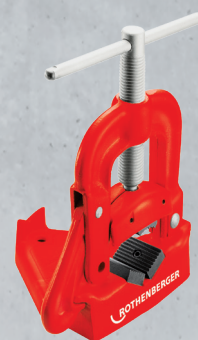

Hinged Yoke Vice
No. 70710
Can attach to portable
work stand (No. 70751)

Further Products

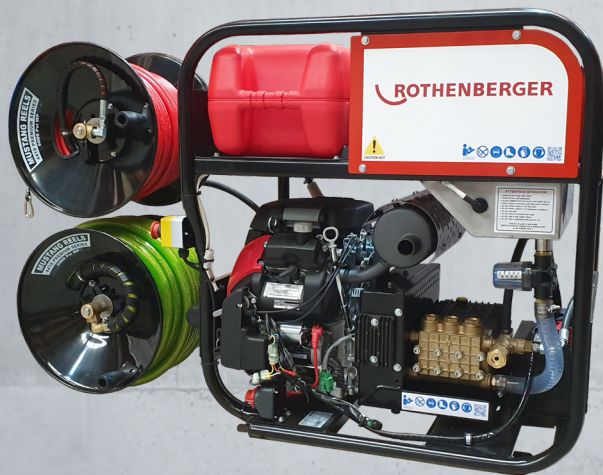

ROBLAST Jetter
No. ROBLAST



ROCAM® 4+ 65 m
No. 1500002619

ROTHENBERGER Australia

6 / 13 Hoyle Avenue
Castle Hill, NSW, 2154

☎ 02 9899 7577
☎ 02 9899 7677
✉ sales-au@rothenberger.com
🌐 rothenberger.com.au