

Essential Inverter Heat Pump

QUICK START GUIDE

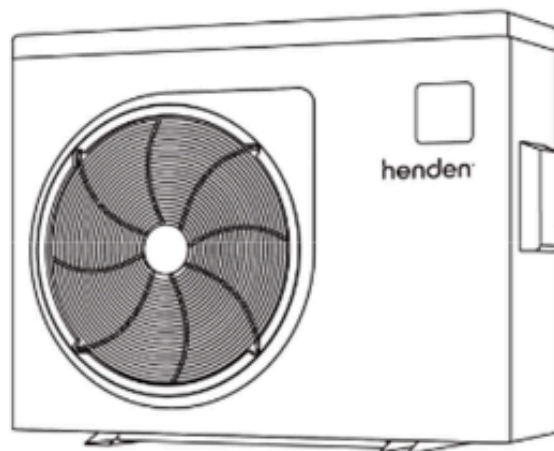

Thank you for purchasing a Henden Inverter Heat Pump.

Built with Inverter Technology for energy efficiency and designed for super quiet operation. Harness the power of this high performing heat pump and enjoy more time in the pool.

HELPFUL HINTS

- Prepare the installation area by removing debris or anything that could restrict ventilation.
- Regularly check the condensate drain for any blockages or debris build up. This will ensure optimal drainage.
- Make sure there is water flowing through the Henden Inverter Heat Pump when operating.
- To maximise efficiency, install the Henden Inverter Heat Pump in line with the ventilation diagrams depicted.
- If you intend to connect the Henden Inverter Heat Pump to the Henden Heat Pump App, ensure you have strong Wi-Fi in the installation location. more than -50dBm is considered suitable for use.

IMPORTANT
Please read carefully



CAUTIONS AND WARNINGS



WARNING: Electrical installation must be carried out by a licenced electrician in accordance with the wiring rules and local regulations.

Keep the Henden Inverter Heat Pump away from any potential fire source.

The Henden Inverter Heat Pump must be placed in a well ventilated area.

Repair must be carried out by manufacturer approved service personnel.

Date Issued: November 2024

Scan to view the complete owners and installation manual:



Thank you for purchasing a Henden Essential Inverter Heat Pump.

Harness the power of this high performing heat pump. Built with DC inverter technology for energy efficiency and quiet operation, this heat pump is essential for any residential pool.

Helpful Hints

- The surroundings of the Henden Essential Inverter Heat Pump should be kept clear to avoid restricting ventilation.
- Install the Henden Essential Inverter Heat Pump in a well-ventilated area.
- Regularly check the condensate hose for blockages and clean as necessary.
- Ensure the Wi-Fi strength at the site of installation is strong (more than -50dBm is recommended).
- Install the Henden Essential Inverter Heat Pump in line with the ventilation diagrams in this guide.
- For optimal heating, the Henden Essential Inverter Heat Pump should be <10m from the pool.
- For a complete heating solution, pair with a Henden 550 Micron Solar Pool Cover. This addition helps reduce energy consumption, heat loss and water evaporation.

Cautions and Warnings

- Installation and maintenance must be carried out by a professional pool builder/service agent in accordance with the installation instructions.
- Repairs should be carried out in a well-ventilated area.
- Failure to follow the installation instructions, building codes, relevant standards and local regulations may cause serious bodily injury and/or property damage.
- This Inverter Heat Pump contains R32 refrigerant gas which is a flammable gas. Keep away from any source of fire.
- Turn *off* the power during thunderstorms and severe weather.
- The Inverter Heat Pump must be positioned on a concrete base. It is recommended that the heat pump is secured using M10 bolts and suitably raised from the ground.
- Do not lift the Inverter Heat Pump using the water unions.
- This appliance is not intended for use by persons (including children) with reduced physical sensory or mental capabilities, or lack of experience and knowledge, unless they have been given supervision or instruction concerning use of the appliance by a person responsible for their safety.
- Children should be supervised to ensure that they do not play with the appliance.

SPECIFICATIONS

Model	Henden Essential Inverter Heat Pump 9kW	Henden Essential Inverter Heat Pump 13kW	Henden Essential Inverter Heat Pump 17kW	Henden Essential Inverter Heat Pump 21kW	Henden Essential Inverter Heat Pump 24kW
Advised pool volume (m ³)	20-35	30-50	35-65	45-80	55-90
Working air temp (°C)	0°C-43°C				
Performance Condition: Air 26°C, Water 26°C, Humidity 80%					
Heating capacity (kW)	9.0	12.5	16.0	20.0	24.0
C.O.P	10.6-6.8	11.6-7.0	11.2-7.1	11.8-6.5	11.8-6.5
C.O.P at 50% capacity	9.6	10.1	9.7	10.2	10.2
Performance Condition: Air 15°C, Water 26°C, Humidity 70%					
Heating capacity (kW)	6.3	8.5	11.0	14.0	16.0
C.O.P	6.1-4.5	6.3-4.8	6.4-4.7	6.5-4.6	6.5-4.6
C.O.P at 50% capacity	5.7	6.1	5.9	6.1	6.2
Performance Condition: Air 35°C, Water 28°C, Humidity 80%					
Cooling capacity (kW)	3.1	4.6	5.6	7.8	9.5
Electrical Rating					
Power supply	230V / 1Ph / 50Hz				
Rated input: Power (kW) / Current (A) Heating (top), Cooling (bottom)	1.60/7.00 1.10/4.90	2.50/11.00 1.90/8.40	3.40/15.00 2.30/9.90	4.20/18.00 2.80/12.00	4.30/19.00 2.80/12.00
Rated input power (kW) at air 15°C	0.36-1.40	0.47-1.78	0.59-2.34	0.75-3.04	0.86-3.48
Rated input current (A) at air 15°C	1.57-6.09	2.02-7.74	2.52-10.17	3.26-13.21	3.74-15.13
Heat Pump Details					
Advised water flow rate (m ³ /h)	3-4	4-6	6.5-8.5	8-10	10-12
Water connection pipe diameter (mm)	48.3				
Dimensions LxWxH (mm)	872x349x654	872x349x654	962x349x654	962x349x754	961x420x758
Net Weight (kg)	46	49	60	58	68

Note: Please take into consideration that the heat pump performance and parameters are different under various conditions.

Note: Related parameters are subject to adjustment periodically for technical improvement without further notice. For details, please refer to the data plate.

INSTALLATION

Positioning the Henden Essential Inverter Heat Pump

1. To begin, position the Henden Essential Inverter Heat Pump on solid level ground. Do not install the unit in an enclosed area.

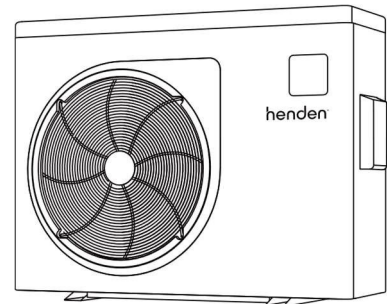

2. Check that there are no objects blocking the air inlet and that the minimum clearance guidelines displayed are followed.

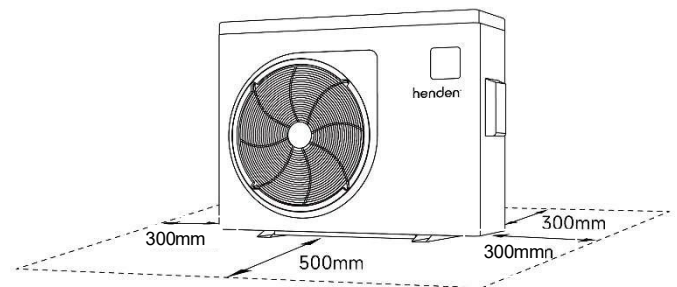

3. Place the 4 rubber feet supplied under the Henden Essential Inverter Heat Pump.

Handy Tip! Henden recommends using M10 Bolts to fix the unit to concrete.

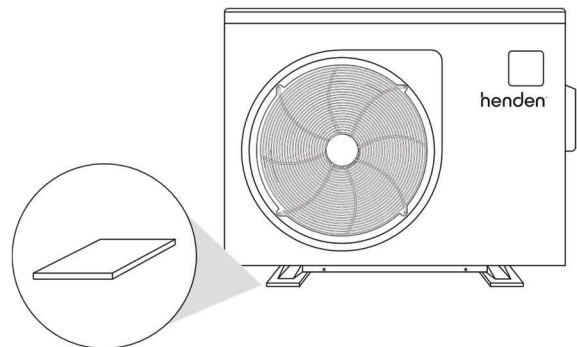

4. Ensure the Henden Essential Inverter Heat Pump is installed with electrical protection devices, including a circuit breaker and electrical isolation switch in accordance with the Wiring Rules.

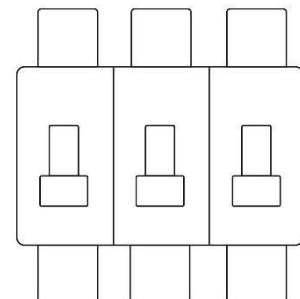

Electrical Installations



WARNING! Electrical installation must only be carried out by a licensed electrician. Electrical Installations must be in accordance with the Wiring Rules, local regulations and the instructions stated in the full manual. To access the full manual, scan the QR code on the front cover of this guide.

Connecting the Condensation Drain

1. Locate the condensate drain thru-hole under the heater and snap-in the supplied elbow on securely. Attach hose to the barb on the elbow.

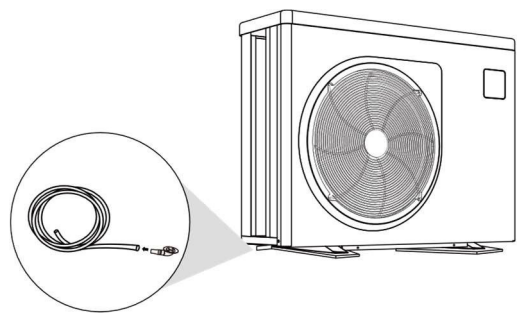

2. Run the drain hose downhill to a suitable location. For example, a garden or nearby stormwater drain. Note: the hose can drain up to 10 litres of condensation per hour.

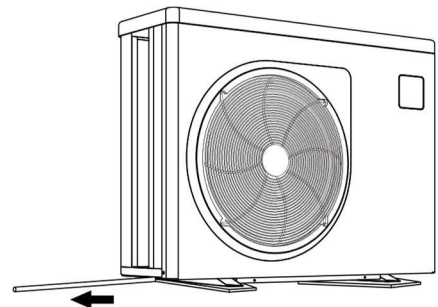

Connecting the pipework

1. Unscrew the plastic nut to remove the blanking cap.

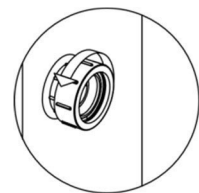

2. Glue the tail to the pipework then use the nut to secure it to the water union on the heat pump.

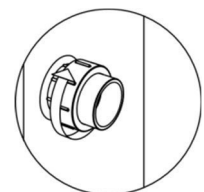

Warning! The inlet and outlet water unions cannot support the weight of soft/flexible pipes. The heat pump must be connected using rigid pipes supported independently.

Handy Tip! To ensure heating efficiency, the pipe run from the pool to the heat pump should be <10m.

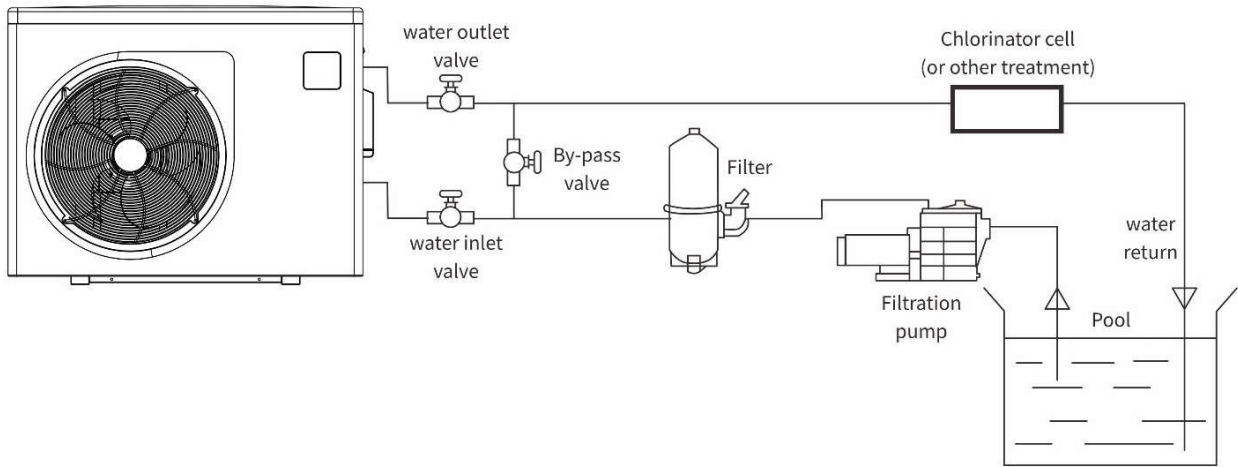

External Connectors Installation

Depending on the type of pool heating and cooling requirements, the Henden Essential Inverter Heat Pump may be operated by external controller.

There are 3 connectors on the side of the unit. These are for external control, RS485 and Pump Control.

- Ext. Control - a dry contact that when closed the heat pump initiates heating/ cooling, and when open the heat pump terminates heating/ cooling. This connector is pre-fitted with a bridging cable which needs to be removed if used with an external controller.
- RS485 - used in conjunction with an external controller with Modbus support.
- Pump Control - a dry contact for controlling water pump using heat pump control logic.

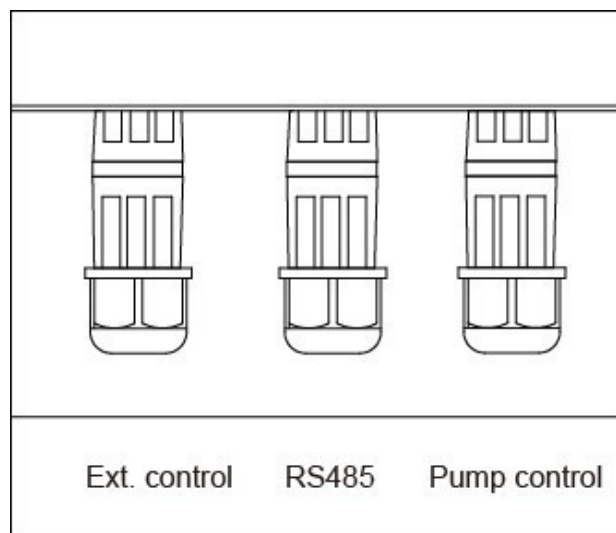

Warning: Above connections are suitable only for use with extra-low voltage. Mains power supply connection must not be made to the connectors.

Disassembling and connecting the signal wire

Follow the diagram below to disassemble to connection point.

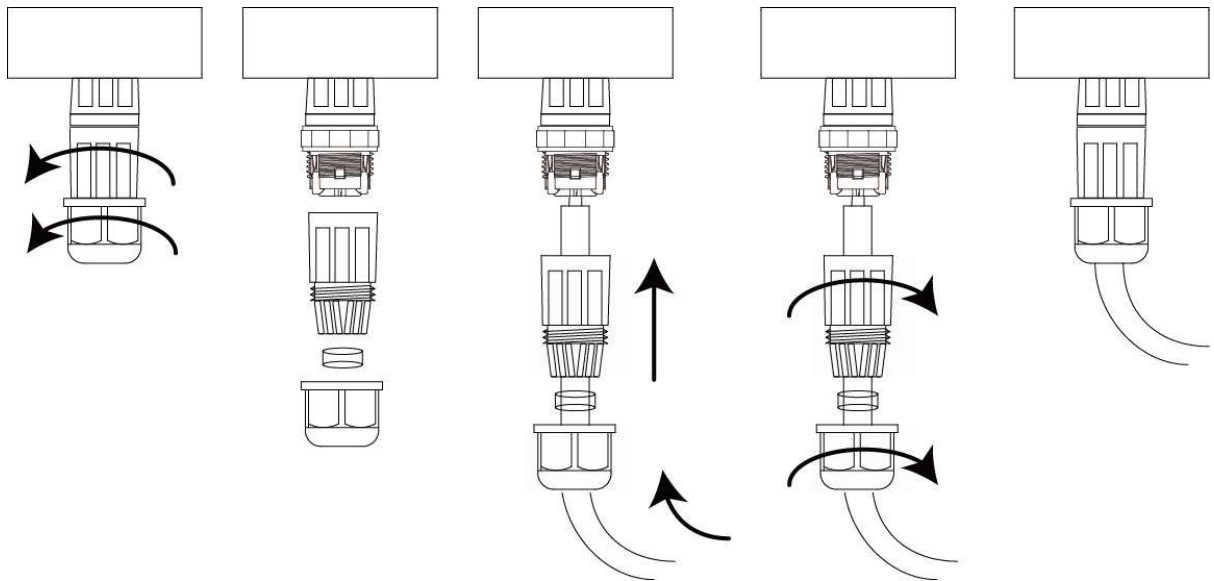

Wiring cables to the connectors

Note: Each connector has a different terminal layout. Follow the direction below..

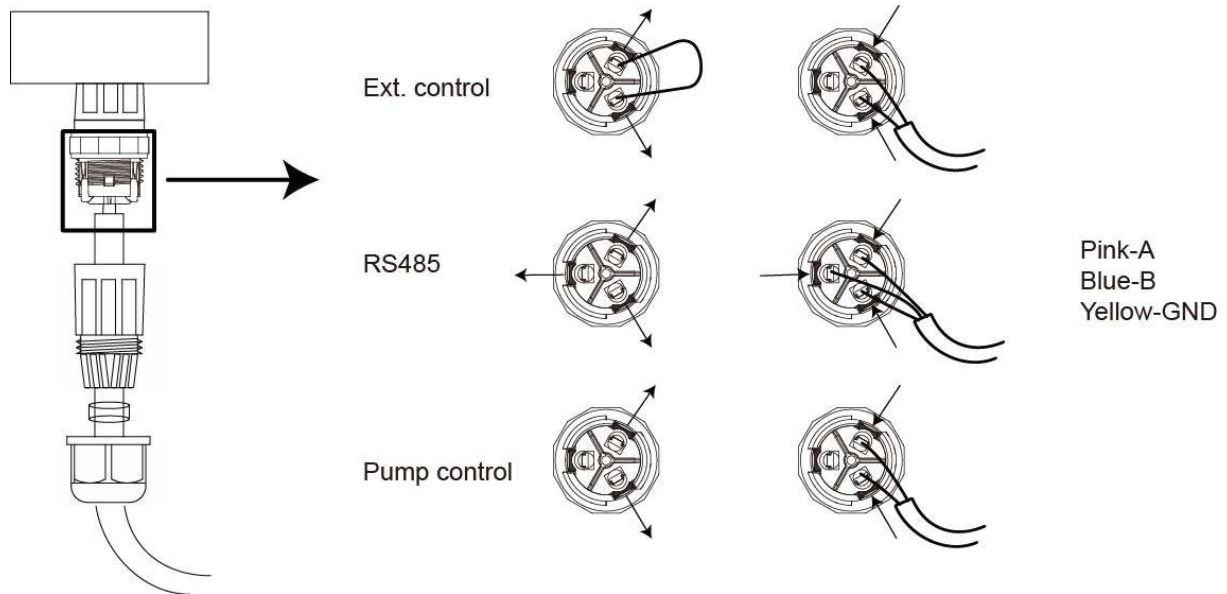

a. Wiring Ext. Control Cable to the connector

After disassembling the connection point, pull the operation key outward. Remove the original wiring and connect the signal wire to the Pink and Blue Port. Once complete, push the operation key inward to lock the signal wire. (Outer diameter dimension of the signal wire : 5-9MM)

b. Wiring RS485 to the connector

After disassembling the connection point, pull the operation key outward. Connect the corresponding signal line according to the terminal of the corresponding colour. Once complete, push the operation key inward to lock the signal wire. (Outer diameter

dimension of the signal wire : 3.5-7MM)

- Pink is connected to signal line A
- Blue is connected to signal line B
- Yellow is connected to GND signal line

c. Wiring Pump Control to the connector

After disassembling the connection point, pull the operation key outward. Remove the original wiring and connect the signal wire to the Pink and Blue Port. Once complete, push the operation key inward to lock the signal wire. (Outer diameter dimension of

the signal wire : 5-9MM)

Setting up the Flow Bypass

1. Create a flow bypass between the inlet and outlet pipework to ensure optimal efficiency. See an example of this using 3 x valves below.

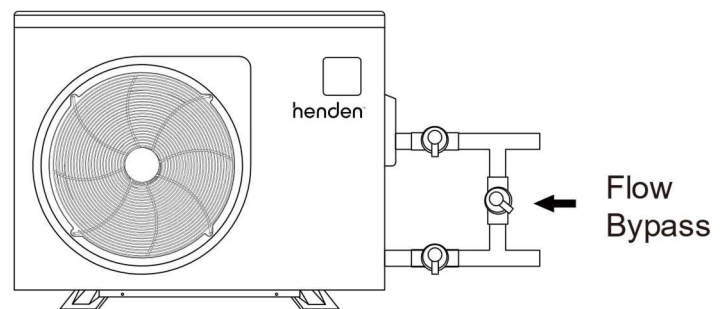

FIRST TIME START UP

1. Open any isolation valves fitted to the heat pump connections.

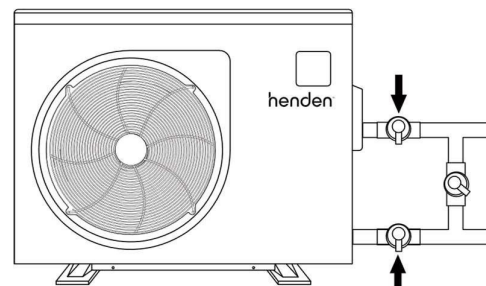

2. With the bypass valve fully open, turn the pool pump on.



3. Check that the pool system circuit is fully filled with water. Check there are no water leaks and verify adequate flow to and from the pool.

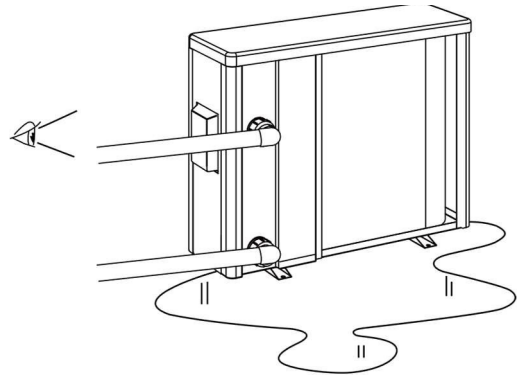

4. Turn on the electrical power supply to the Henden Essential Inverter Heat Pump from the isolation switch.

5. Press the power symbol on the control panel. The Henden Essential Inverter Heat Pump will turn on within a few seconds.



6. Once on, the Henden Essential will run for 1 minute before the compressor kicks in.

7. To adjust the bypass and calibrate the flow rate, open all isolating valves.

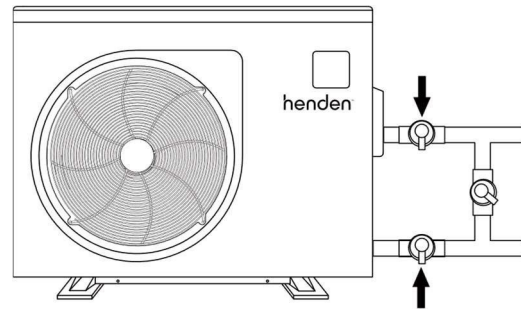

8. To adjust the bypass and calibrate the flow rate, first fully close the flow bypass.

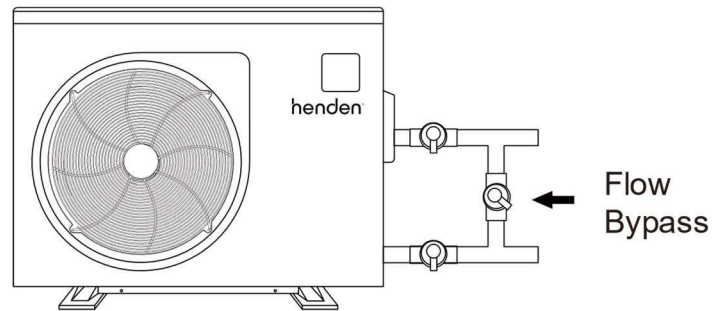

9. Wait 3-4 minutes until the Henden Essential Inverter Heat Pump is at 100% capacity.



10. Slowly open the flow bypass valve to increase the temperature differential between the inlet and outlet. Closing the bypass valve will decrease the temperature differential. Adjust until optimum differential of 2-3°C is achieved.

Handy Tip! Wait two minutes between each adjustment.

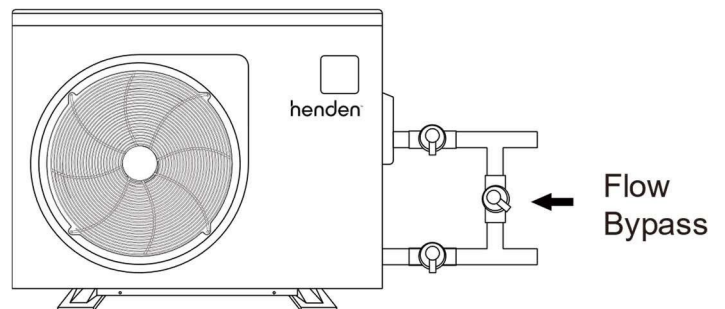

11. The initial start-up is complete. Allow the heat pump to run 24 hours per day until the desired pool temperature is reached. This can take several days.



USING THE APP

The ***Henden Heat Pump*** App can be used to control and monitor your Henden Inverter Heat Pump via Wi-Fi.





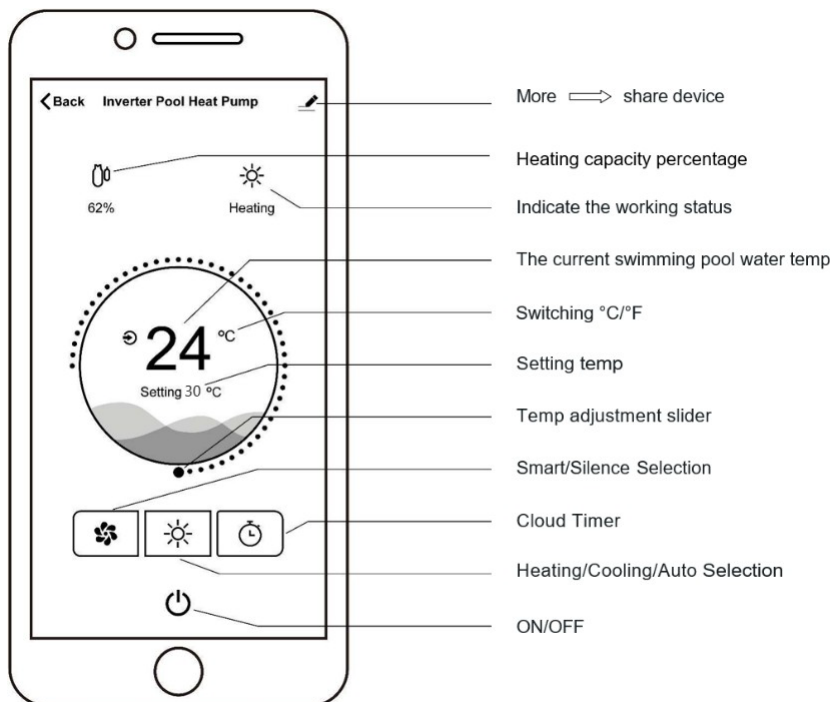
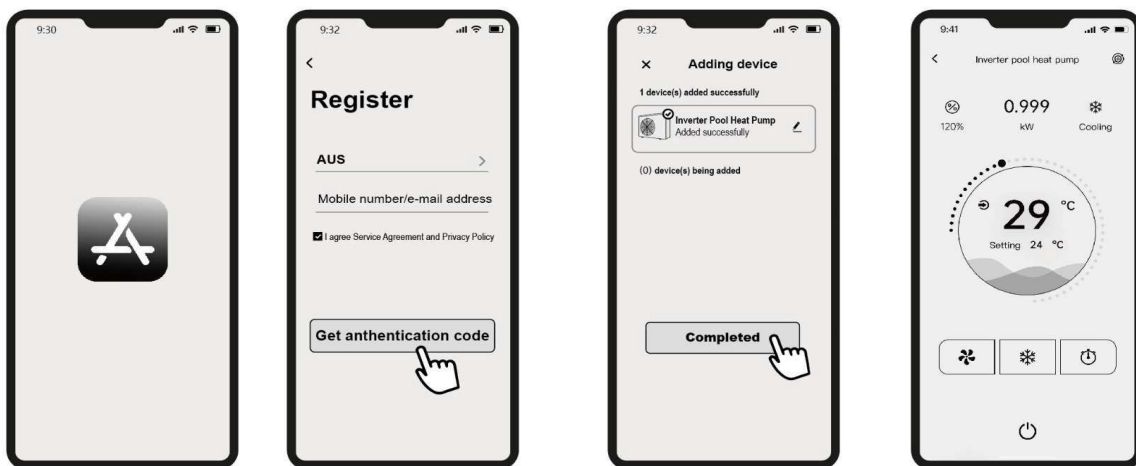

To set up the ***Henden Heat Pump*** App, follow the steps below:

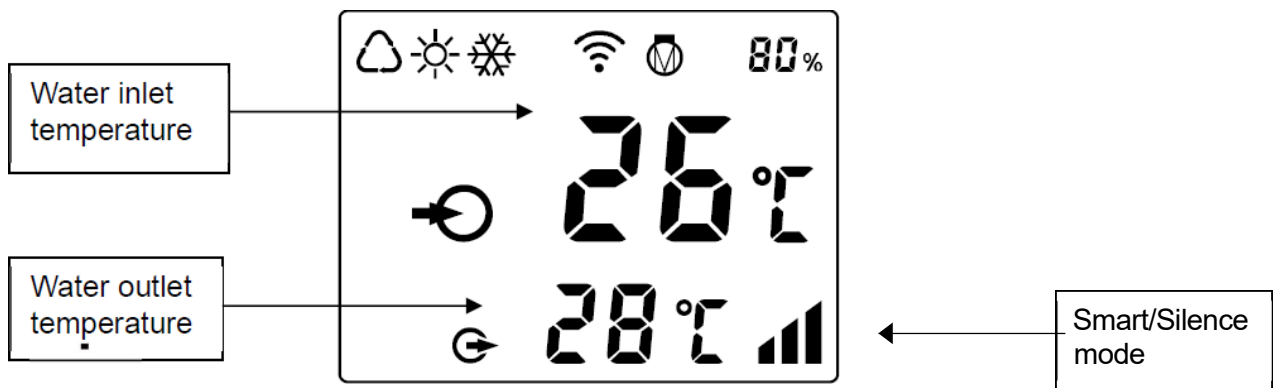



1. Open the Apple App Store or Google Play and download ***Henden Heat Pump***.
2. Open ***Henden Heat Pump*** and follow the prompts to create an account.
3. Press and hold the power button on the Inverter Heat Pump for 3 seconds to activate Wi-Fi pairing.
4. Open the ***Henden Heat Pump*** and select Add a Device.
5. Follow the prompts in the App to set and monitor the pool water temperature



Interpreting the keys:



	Auto
	Heating
	Cooling
	Heating capacity percentage
	Wi-Fi connection
	Water inlet
	Water outlet

SYMBOL	DESIGNATION	FUNCTION
	ON/OFF	<ol style="list-style-type: none"> 1. Power On/Off 2. Wi-Fi setting
	Unlock	<ol style="list-style-type: none"> 1. Press it for 3 seconds to unlock/lock screen 2. After screen is unlocked, press it to select mode. Auto 12~40°C Heating 18~40°C Cooling 12~30°C
	Speed	Select Smart/Silence mode
	Up/ Down	Adjust set temperature

MAINTENANCE

1. Clean the pool filter regularly to ensure adequate water flow through the heater and avoid damage.
2. Use freshwater at a low pressure to clean the fins on the air inlet regularly.
3. If not in use for long periods of time (e.g. colder months), discharge all water in the Henden Essential Inverter Heat Pump, including the water at the bottom. This prevents water from freezing in the Henden Essential Inverter Heat Pump and potentially causing damage.

This page has been left intentionally blank.

Date Issued: November 2024.

This page has been left intentionally blank.

Date Issued: November 2024.

This page has been left intentionally blank.

Date Issued: November 2024.