

# KDD 9/9T 350W 4P-1 3SA

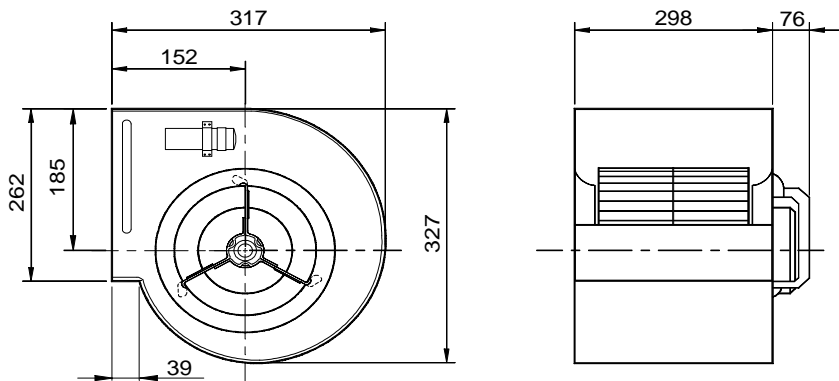

|      |                |       |           |          |               |
|------|----------------|-------|-----------|----------|---------------|
| VOLT | 220-240        | Ph    | 1         | SL.      | KD09004.1     |
| WATT | 350            | Hz    | 50        | Part No. | CE-AD1F733.00 |
| RPM  | 1330/1150/1050 | Cl.   | F         | uF/V     | 12.5/450      |
| POLE | 4              | Temp. | min -20°C | N. Amp   | 2.4           |
| IP   | 21             |       | max +40°C | M. Amp   | 3.3           |
|      |                |       |           | Date     | 11/5/01       |
|      |                |       |           | Weight   | 13.0 kg       |

## Wiring diagram

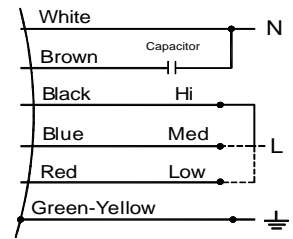

All Dimension in mm

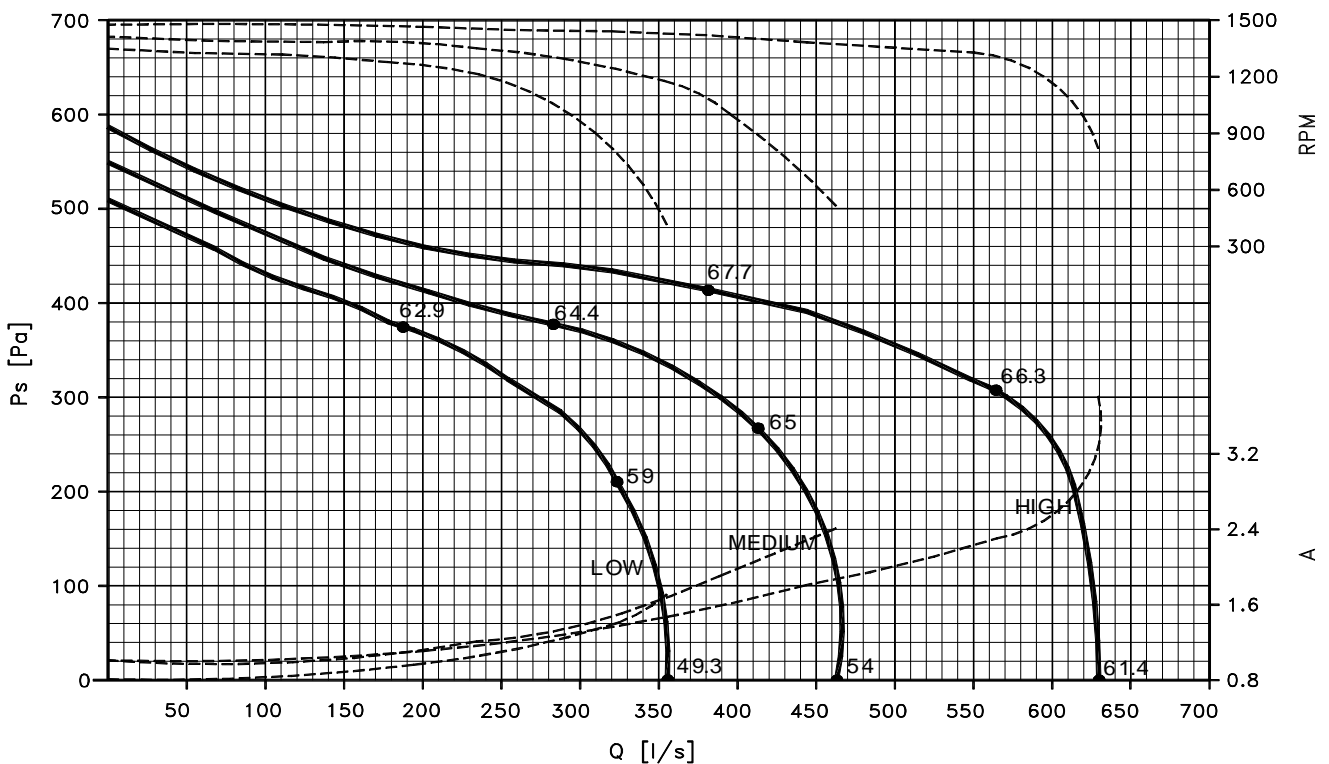

\* Sound Lp(A) at 1 m free field.

\* Performance shown is for installation type B - free inlet, ducted outlet