

## MODELS

## RBA MODULAR RAILS

<b>RBA4601-171</b>	Raffaello 90° LH Accessible Grab Rail, White
<b>RBA4601-178</b>	Raffaello 90° LH Accessible Grab Rail, Matte Black
<b>RBA4601-179</b>	Raffaello 90° LH Accessible Grab Rail, Chrome
<b>RBA4601-181</b>	Raffaello 90° RH Accessible Grab Rail, White
<b>RBA4601-188</b>	Raffaello 90° RH Accessible Grab Rail, Matte Black
<b>RBA4601-189</b>	Raffaello 90° RH Accessible Grab Rail, Chrome
<b>RBA4601-259</b>	Raffaello 90° LH Wraparound Grab Rail, Matte Black
<b>RBA4601-260</b>	Raffaello 90° RH Wraparound Grab Rail, Matte Black

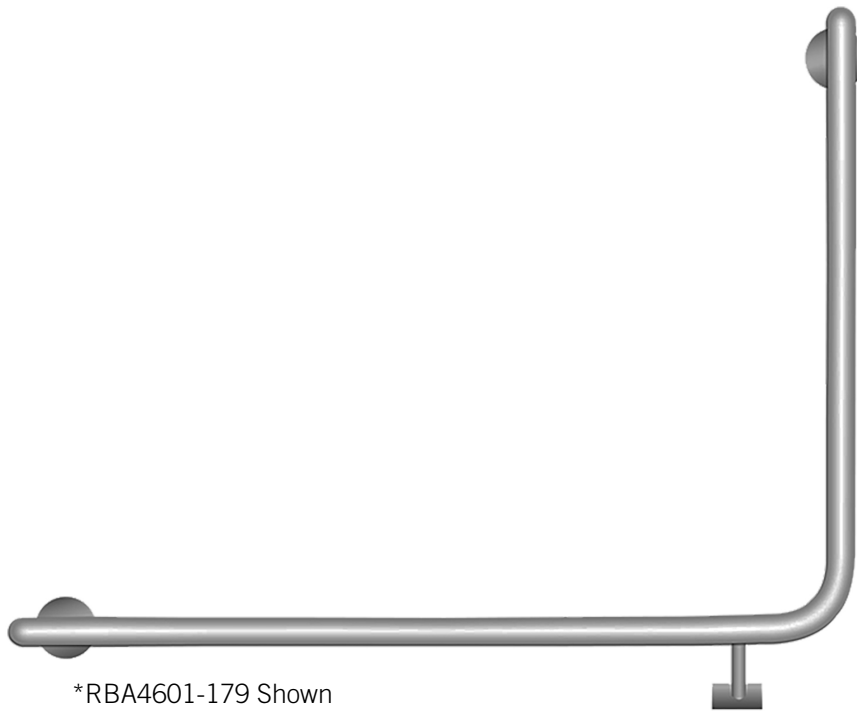

\*RBA4601-179 Shown



## Attention

You are responsible for the safe operation of this unit. For optimum installation use at least 4 suitable screws for each wall-plate. Screws should be selected to suit the wall type. Grab Rails are no stronger than the anchors or walls to which they are attached, and therefore, must be firmly secured in order to support the loads for which they are intended.

Exceeding the maximum load values may cause permanent product damage. If this happens, cease use until checked by a specialised maintenance person. Improper use, such as for gymnastic exercises or as a step, may cause accidents with serious consequences. Reliable operation and product safety depend on the way the products are installed and used.

Ensure installation is performed by qualified personnel. Incorrect installation can seriously compromise product functionality.

## Maintenance and Cleaning Instructions

Do not use detergents containing bleach, acids, alkalis, or chlorine or abrasive products. Do not use abrasive objects (e.g. scouring pads). Do not use chemicals that can damage plastic. Clean the surface with water and a neutral detergent; rinse carefully and dry with a clean cloth. If alternative cleaning methods and/or chemicals are used, warranty may become void.

## Tools Required

- Screw Driver
- Extended Driver Bit
- Spirit Level

## Components Supplied for RBA4601-17 Series & RBA4601-18 Series

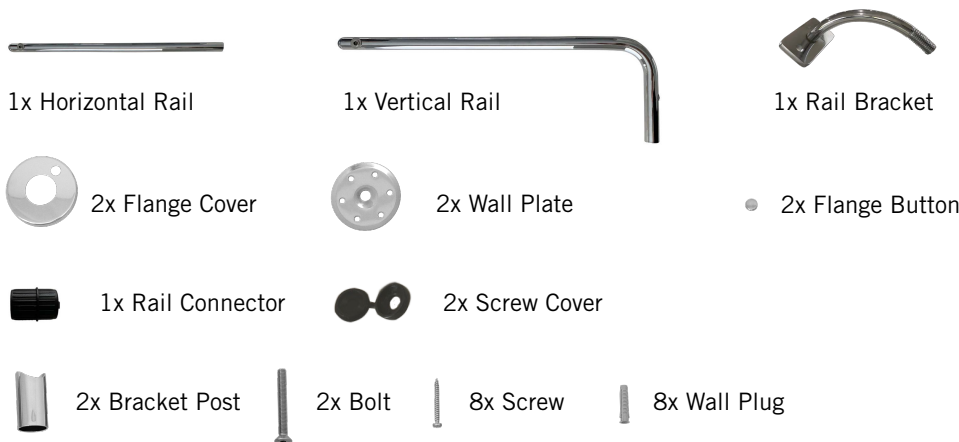

## Components Supplied for RBA4601-260 & RBA4601-259



1. Lay rail flat with thread facing up

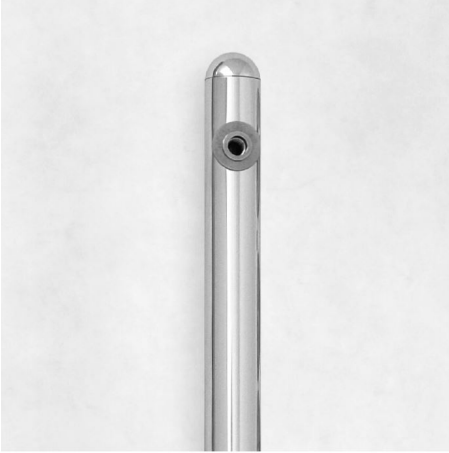

2. Place bracket post onto rail



3. Slide flange cover over post



4. Insert bolt through wall plate



5. Insert wall plate and bolt assembly

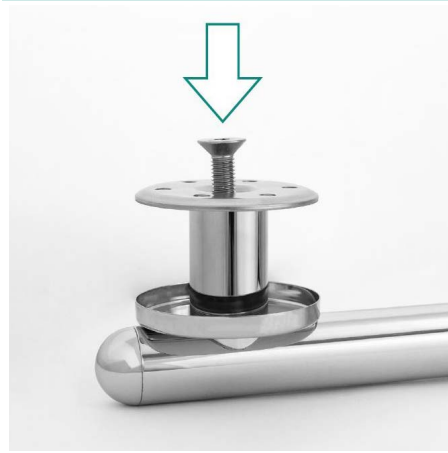

6. Tighten



7. Repeat for other fixing points



8. Screw rail bracket into threaded insert

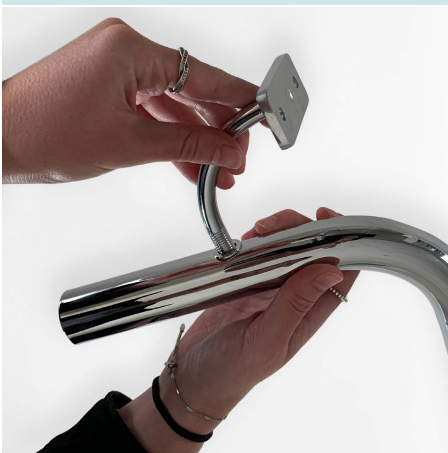

9. Connect rails.

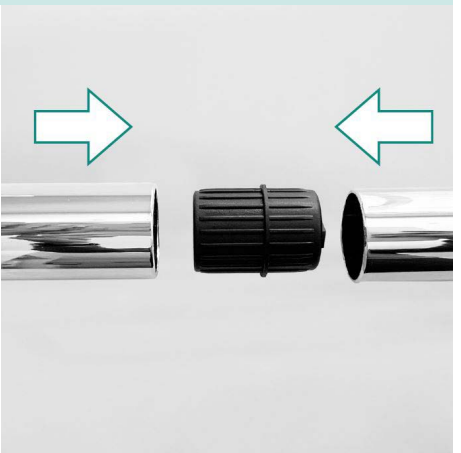

10. Ensure snug fit.



11. Ensure rail is level



12. Mark location to install.



13. Position flange cover so the hole is over the screw fixing point. Secure the first screw.

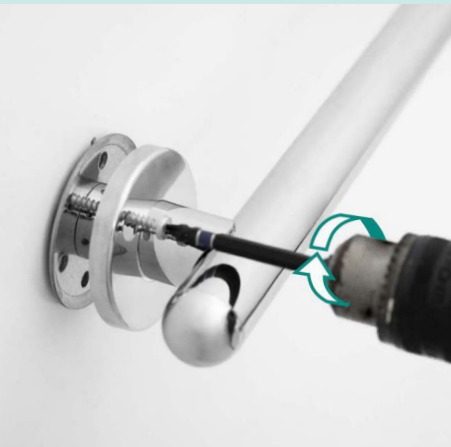

14. Rotate the flange cover so the hole is positioned over a new screw fixing point.

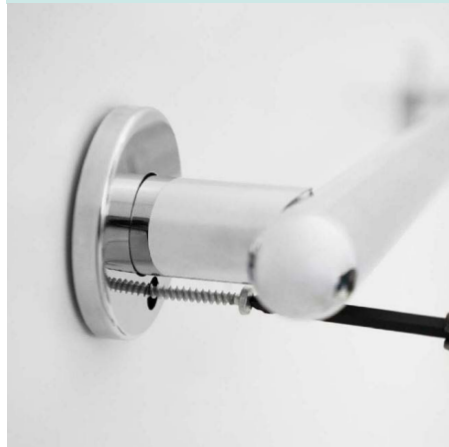

15. Push flange cover over wall plate and insert flange button.



16. Place screw into screw cover before securing rail bracket

