











Mizu Stream Non-Heated Towel Rail

INSTALLATION INSTRUCTIONS

Parts for wall-mounted installation

| | | | |
|--|--|--|--|
|  4x |  3x |  4x |  3x |
|  3x |  4x |  1x |  1x |
|  1x |  4x |  1x | |

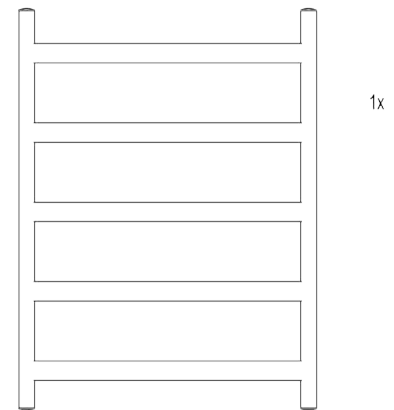

*generic product image used

1

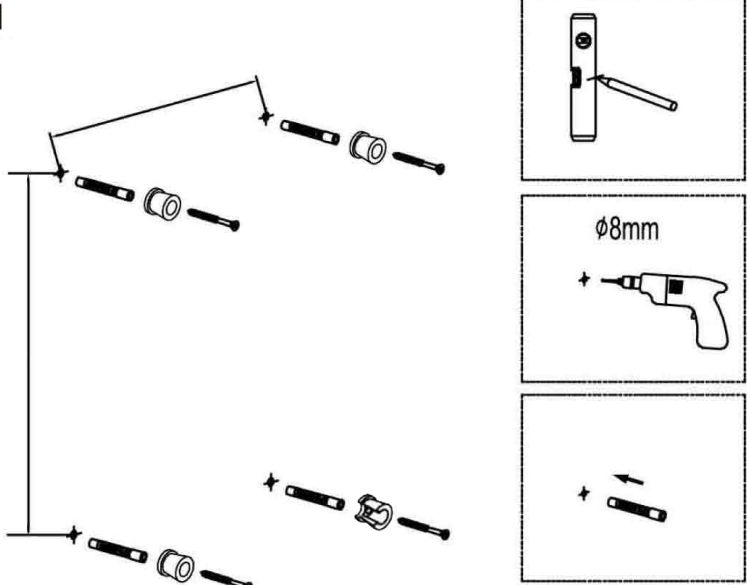

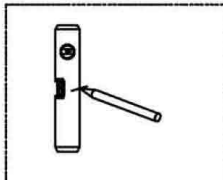

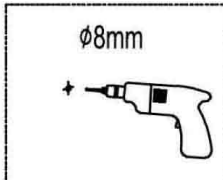

Ø8mm

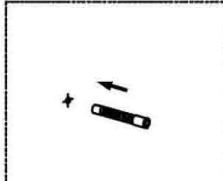

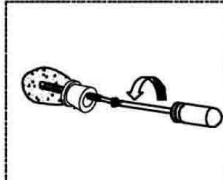





- Fix to the wall as pictured

- Use the fixing point distances provided to mark out the fixing points.
- Before drilling, check that the product aligns to the marked fixing points and make adjustments if necessary.
- Note: Wall materials vary. The fixing kit supplied is suited for solid wall fixing. For timber framed walls, please ensure the product is fixed to a stud/noggin behind the wall. Where a stud/noggin is not available, please use suitable hollow wall fixing.

Mizu Stream Non-Heated Towel Rail

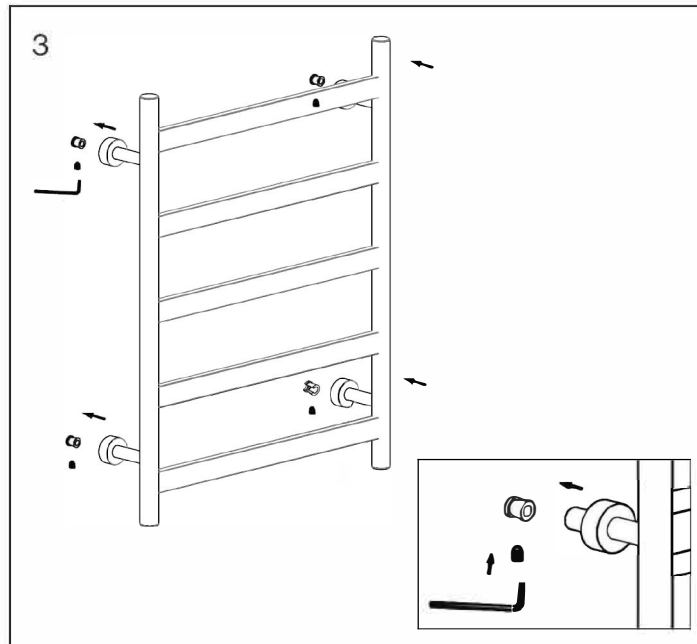
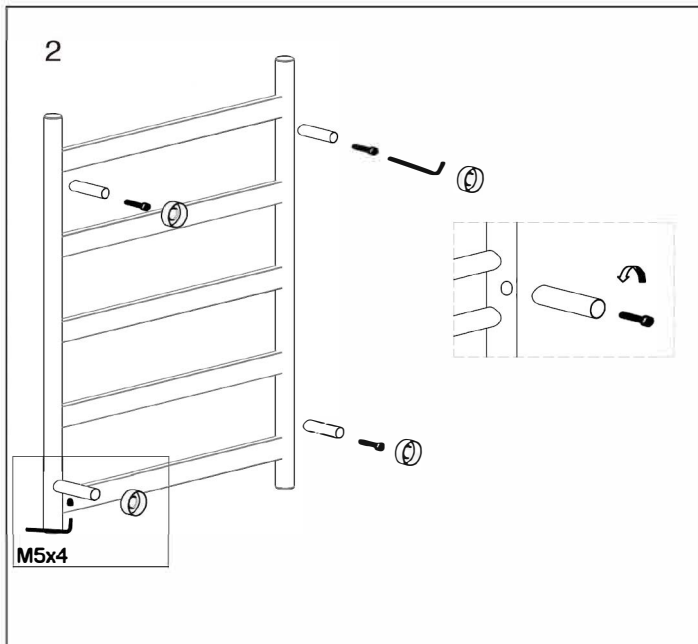

- With the allen key provided, tighten the grub screws to ensure that towel rail stays in position.

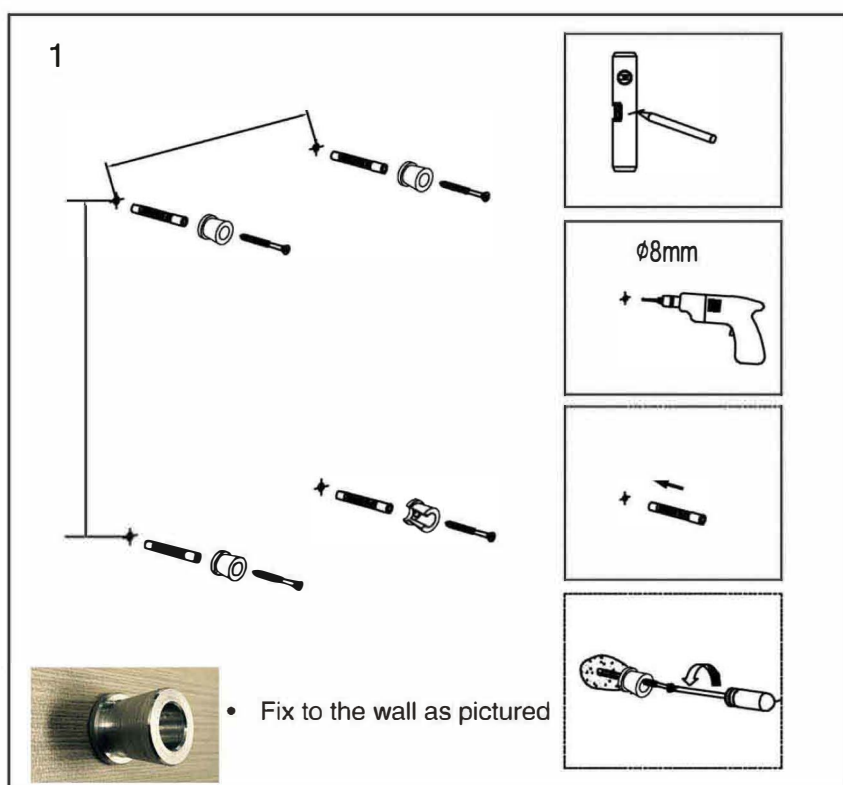

- Use the fixing point distances provided to mark out the fixing points.
- Before drilling, check that the product aligns to the marked fixing points and make adjustments if necessary.
- Note: Wall materials vary. The fixing kit supplied is suited for solid wall fixing. For timber framed walls, please ensure the product is fixed to a stud/noggin behind the wall. Where a stud/noggin is not available, please use suitable hollow wall fixing.