

Owner's Guide and Installation Instructions



Air Sourced 251E280 Heat Pump Water Heater

EVERHOT

*This water heater must be installed and serviced by a qualified person.
Please leave this guide with the householder.*

An electronic copy of these Owner's Guide and Installation Instructions can be downloaded from rheem.com.au.

PATENTS

This water heater may be protected by one or more patents or registered designs in the name of Rheem Australia Pty Ltd.

TRADE MARKS

® Registered trademark of Rheem Australia Pty Ltd.
™ Trademark of Rheem Australia Pty Ltd.

Note: Every care has been taken to ensure accuracy in preparation of this publication. No liability can be accepted for any consequences, which may arise as a result of its application.

CONTENTS

HOUSEHOLDER

This booklet contains important information about your new water heater, including terms of the Everhot warranty.

We recommend you read pages 7 to 29, and the terms of the Everhot warranty on pages 4 to 6.

The other pages are intended for the installer but may be of interest.

Warranty	4
Safety, Warnings, Installation Notes	7
About Your Water Heater	10
Display Panel	14
Maintenance Requirements.....	22
Water Supplies.....	24
Save A Service Call	27
Installation.....	30
Connections – Plumbing	37
Connections – Electrical.....	40
Commissioning.....	42
Draining The Water Heater	43
Maintenance, Repair, Decommissioning, Disposal	44
Installation Report	49

RHEEM AUSTRALIA PTY LTD, A.B.N. 21 098 823 511

www.rheem.com.au

For Service Telephone 131 031 AUSTRALIA

EVERHOT HEAT PUMP WATER HEATER WARRANTY

- AUSTRALIA -

HEAT PUMP WATER HEATER MODELS 251E280

1. THE EVERHOT WARRANTY – GENERAL

- 1.1 This warranty is given in Australia by Rheem Australia Pty Limited ABN 21 098 823 511 of 1 Alan Street, Rydalmere New South Wales, the manufacturer of Everhot mains pressure water heaters.
- 1.2 Rheem offer a trained and qualified national service network who will repair or replace components at the address of the water heater subject to the terms of the Everhot warranty. Rheem Service, in addition can provide preventative maintenance and advice on the operation of your water heater. The Rheem Service contact number is 131031, with Contact Centre personnel available 24 hours, 7 days a week to take your call and if necessary to arrange a service call for during normal working hours Monday to Friday (hours subject to change).
- 1.3 For details about this warranty, you can contact us on 131031 or by email at warrantyenquiry@rheem.com.au (not for service bookings).
- 1.4 The terms of this warranty and what is covered by it are set out in sections 2 and 3 and apply to water heaters manufactured from the 1st June 2024.
- 1.5 If a subsequent version of this warranty is published, the terms of that warranty and what is covered by it will apply to water heaters manufactured after the date specified in the subsequent version.

2. TERMS OF THE EVERHOT WARRANTY AND EXCLUSIONS TO IT

- 2.1 The decision of whether to repair or replace a faulty component is at Rheem's sole discretion.
- 2.2 If you require a call out and we find that the fault is not covered by the Everhot warranty, you are responsible for our standard call out charge. If you wish to have the relevant component repaired or replaced by Rheem, that service will be at your cost.
- 2.3 Where a failed component or cylinder is replaced under this warranty, the balance of the original warranty period will remain effective. The replacement does not carry a new Everhot warranty.
- 2.4 Where the water heater is installed outside the boundaries of a metropolitan area as defined by Rheem or further than 25 km from either a regional Rheem branch office or an Accredited Rheem Service Agent's office, the cost of transport, insurance and travelling between the nearest branch office or Rheem Accredited Service Agent's office and the installed site shall be the owner's responsibility.
- 2.5 Where the water heater is installed in a position that does not allow safe or ready access, the cost of that access, including the cost of additional materials handling and/or safety equipment, shall be the owner's responsibility. In other words, the cost of dismantling or removing cupboards, doors or walls and the cost of any special equipment to bring the water heater to floor or ground level or to a serviceable position is not covered by this warranty.
- 2.6 This warranty only applies to the original and genuine Everhot water heater in its original installed location and any genuine Everhot replacement parts.
- 2.7 The Everhot warranty does not cover faults that are a result of:
 - a) Accidental damage to the water heater or any component (for example: (i) Acts of God such as floods, storms, fires, lightning strikes and the like; and (ii) third party acts or omissions).
 - b) Misuse or abnormal use of the water heater.
 - c) Installation not in accordance with the Owner's Guide and Installation Instructions or with relevant statutory and local requirements in the State or Territory in which the water heater is installed.
 - d) Connection at any time to a water supply that does not comply with the water supply guidelines as outlined in the Owner's Guide and Installation Instructions.

EVERHOT HEAT PUMP WATER HEATER WARRANTY - AUSTRALIA -

HEAT PUMP WATER HEATER MODELS 251E280

- e) Repairs, attempts to repair or modifications to the water heater by a person other than Rheem Service or a Rheem Accredited Service Agent.
 - f) Faulty plumbing or faulty power supply.
 - g) Failure to maintain the water heater in accordance with the Owner's Guide and Installation Instructions.
 - h) Transport damage.
 - i) Fair wear and tear from adverse conditions (for example, corrosion).
 - j) Cosmetic defects.
 - k) Ice formation in the waterways of a water heater system incorporating a freeze protection system where the electricity supply has been switched off or has failed.
- 2.8 Rheem may reject a claim under this warranty in its sole discretion if a third party solar diverter is connected to the water heater.
- 2.9 Subject to any statutory provisions to the contrary, this warranty excludes any and all claims for damage to furniture, carpet, walls, foundations or any other consequential loss either directly or indirectly due to leakage from the water heater, or due to leakage from fittings and/ or pipe work of metal, plastic or other materials caused by water temperature, workmanship or other modes of failure.
- 2.10 If the water heater is not sized to supply the hot water demand in accordance with the guidelines in the Everhot water heater literature, any resultant fault will not be covered by the Everhot warranty.

3. WHAT IS COVERED BY THE EVERHOT WARRANTY FOR THE WATER HEATERS DETAILED IN THIS DOCUMENT

- 3.1 Rheem will repair or replace a faulty component of your water heater if it fails to operate in accordance with its specifications as follows:

What components are covered	The period from the date of installation in which the fault must appear in order to be covered	What coverage you receive
251E280 models		
All components	Year 1	Repair and/or replacement of the faulty component, free of charge, including labour.
Sealed System* components (if the water heater is installed in a single-family domestic dwelling)	Years 2 & 3	Repair and/or replacement of the faulty component, free of charge, including labour.
The cylinder (if the water heater is installed in a single-family domestic dwelling)	Years 2 & 3	Repair and / or replacement of the cylinder, free of charge, including labour.
	Years 4 & 5	Replacement cylinder, free of charge. Installation and repair labour costs are the responsibility of the owner.
The cylinder (if the water heater is <u>not</u> installed in a single-family domestic dwelling)	Years 2 & 3	Replacement cylinder, free of charge. Installation and repair labour costs are the responsibility of the owner.

* The Sealed System includes components that carry refrigerant only, e.g. Compressor, Condenser, TX Valve, Receiver / Drier, Evaporator and associated pipe work.

EVERHOT HEAT PUMP WATER HEATER WARRANTY - AUSTRALIA -

HEAT PUMP WATER HEATER MODELS 251E280

- 3.2 Without limiting the periods shown in the table in Clause 3.1, a 5-year whole-of-product warranty applies where a rebate has been received under Solar Victoria's Solar Homes Program. For further details, call 131 031. Proof of receipt of the rebate is required to be produced at the time of the service call.

4. ENTITLEMENT TO MAKE A CLAIM UNDER THIS WARRANTY

- 4.1 To be entitled to make a claim under this warranty you need to:
- a) Be the owner of the water heater or have consent of the owner to act on their behalf
 - b) Contact Rheem Service without undue delay after detection of the defect and, in any event, within the applicable warranty period.
- 4.2 You are not entitled to make a claim under this warranty if your water heater:
- a) Does not have its original serial numbers or rating labels.
 - b) Is not installed in Australia.

5. HOW TO MAKE A CLAIM UNDER THIS WARRANTY

- 5.1 If you wish to make a claim under this warranty, you need to:
- a) Contact Rheem on 131031 and provide owner's details, address of the water heater, a contact number and date of installation of the water heater or if that's unavailable, the date of manufacture and serial number (from the rating label on the water heater).
 - b) Rheem will arrange for the water heater to be tested and assessed on-site.
 - c) If Rheem determines that you have a valid warranty claim, Rheem will repair or replace the water heater in accordance with this warranty.
- 5.2 Any expenses incurred in the making of a claim under this warranty will be borne by you.

6. THE AUSTRALIAN CONSUMER LAW

- 6.1 Our goods come with guarantees that cannot be excluded under the Australian Consumer Law. You are entitled to a replacement or refund for a major failure and for compensation for any other reasonably foreseeable loss or damage. You are also entitled to have the goods repaired or replaced if the goods fail to be of acceptable quality and the failure does not amount to a major failure.
- 6.2 The Everhot warranty (set out above) is in addition to any rights and remedies that you may have under the Australian Consumer Law.

SAFETY, WARNINGS, INSTALLATION NOTES

It is important you read the following [Safety and Warnings](#), and [Relief Valves](#) information.

SAFETY AND WARNINGS

- The heat pump will operate until a water temperature of 60°C is reached. If the ambient air temperature is outside of the heat pump's operating range and heating of water is required, an electric heating unit will heat the water to this setting.

These temperatures are sufficiently hot to cause severe scalding. Water at this temperature may have been plumbed to fixtures where water hotter than 50°C is allowed, such as the kitchen and laundry.

Refer to;

- [“How Hot Should the Water Be?”](#) on page 11, and
 - [“Hotter Water Increases the Risk of Scald Injury”](#) on page 11, and
 - [“Temperature Adjustment”](#) on page 11.
- This water heater is only intended to be operated by persons who have the experience or the knowledge and the capabilities to do so.
 - This water heater is not intended to be operated by persons with reduced physical, sensory or mental capabilities i.e. the infirm, or by children. Children should be supervised to ensure they do not interfere with or play with or at the water heater.
 - If the electrical supply conduit to the water heater is damaged, it must be replaced by a qualified person in order to avoid a hazard. Phone Rheem Service or their nearest Accredited Service Agent to arrange for an inspection.
 - This water heater uses 220 V - 240 V a.c. electrical power for operation of the control systems and the electrically operated components. The removal of the access covers will expose 220 V - 240 V a.c. wiring. They must only be removed by a qualified person. Do not operate the water heater with any of the covers removed.
 - This water heater is supplied with an electronic thermostat, an over-temperature energy cut-out and a combination temperature pressure relief valve. These devices must not be tampered with or removed. The water heater must not be operated unless each of these devices is fitted and is in working order.

The Everhot warranty may not cover faults if the relief valve or other safety devices are tampered with or if the installation is not in accordance with these instructions.

- **DANGER:** The operation of the over-temperature cut-out on the thermostat indicates a possibly dangerous situation. If the over-temperature cut-out operates, it must not be reset and the water heater must be serviced by a qualified person.
- For continued safety of this water heater, it must be installed, operated and maintained in accordance with the Owner's Guide and Installation Instructions.
- The lever on the temperature pressure relief valve and expansion control valve (if fitted) requires to be operated every six (6) months to clear any deposits and to ensure the valve and its drain line are not blocked.

Refer to:

- [“Relief Valves”](#) on page 8, and
 - [“Minor Maintenance Every Six Months”](#) on page 22.
- Servicing of the water heater must only be carried out by qualified personnel. Phone Rheem Service or their nearest Accredited Service Agent.
 - Only a person qualified to install or service a water heater can drain the water heater, if this is required.
 - Do not modify this water heater.

- In areas where there is a risk of freezing conditions, power must be available to the water heater at all times and the electrical supply to the water heater should not be switched off, otherwise damage could result.

Refer to:

- “Freeze Protection” on page 10, and
- “To Turn Off the Water Heater” on page 12.
- Do not use **aerosols, stain removers and household chemicals** in the vicinity of this water heater while it is in operation. Gases from some aerosol sprays, stain removers and household chemicals are corrosive to the materials used in the heat pump system.
- Do not store swimming pool chemicals, household cleaners, etc., near the water heater.
- Ensure the air flow, air inlet louvres and outlet grille are not obstructed in any way at any time.



WARNINGS – REFRIGERANT

- Be aware that the refrigerant used in this heat pump is flammable and may not contain an odour if it were to leak.
- Do not use any means to accelerate the defrosting process of the evaporator coil or other components of the heat pump.
- Do not pierce or burn any components of the heat pump.

RELIEF VALVES

Temperature Pressure Relief Valve

This water heater incorporates a temperature pressure relief valve located near the top of the water heater. This valve is essential for the water heater’s safe operation.

It is possible for the valve to discharge a quantity of water through the drain line during each heating period. This quantity should be equal to approximately 1/50 of the hot water used, as water expands by this volume when heated.

Expansion Control Valve

In many areas, including South Australia, Western Australia and scaling water areas, it is mandatory an expansion control valve is fitted to the cold water line to the water heater.

The expansion control valve will discharge the quantity of water from its drain line during the heating period instead of the temperature pressure relief valve as it has a lower pressure rating.

Valve Operation

Continuous leakage of water from either valve and its drain line may indicate a problem with the water heater. Refer to “**Temperature Pressure Relief Valve or Expansion Control Valve Running**” on page 28.

Warning: Never block the outlet of either valve or their drain lines for any reason. A relief valve drain must be left open to atmosphere and be installed in a continuously downward direction.

In locations where water pipes are prone to freezing, the relief valve drain line must be insulated and not exceed 300 mm in length before discharging into a tundish through an air gap.

Operate the easing lever on the temperature pressure relief valve and expansion control valve once every six (6) months to clear any deposits and ensure the valve and its drain line are not blocked. **It is very important the lever is raised and lowered gently.** Refer to “**Minor Maintenance Every Six Months**” on page 22.

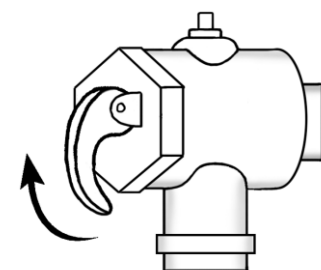
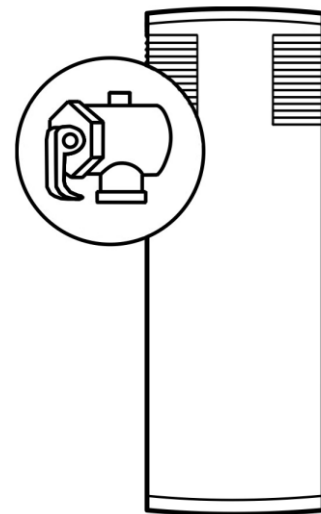

lift until water flows from the drain line – lower gently

outlet / drain line

⚠ Warning: Water discharged from the temperature pressure relief valve drain line will be hot. Exercise care to avoid any splashing of water by standing clear of the drain line's point of discharge when operating either valve's easing lever.

⚠ DANGER: Failure to operate the easing lever on the relief valve once every six (6) months may result in the water heater cylinder failing, or under certain circumstances, exploding.

If water does not flow freely from the drain line when the lever is lifted, then the water heater must be checked. Phone Rheem Service or their nearest Accredited Service Agent to arrange for an inspection.

The temperature pressure relief valve should be replaced at intervals not exceeding five (5) years and the expansion control valve should be checked for performance or replaced at intervals not exceeding five (5) years. The checking of the valves performance or replacement should occur more frequently in areas where there is a high incidence of water deposits. Refer to **"Water Supplies"** on page 24.

INSTALLATION NOTES

This water heater must be installed:

- by a qualified person,
- in accordance with the installation instructions,
- in compliance with the Plumbing Code of Australia (PCA) and Plumbing Standard AS/NZS 3500.4,
 - This water heater is designed for outdoor installation only in a well ventilated area.
 - This water heater is intended to be permanently connected to the water mains and not connected by a hose-set. A braided flexible hose or semi-flexible connector may be used for connection to the water heater, where permitted by AS/NZS 3500.4.
 - Refer to **dimensions diagram** on page 34 for clearance requirements to provide adequate ventilation for the heat pump.
- in compliance with the Australian / New Zealand Wiring Rules AS/NZS 3000,
 - Isolation switches must be installed in the electrical circuit to the water heater in accordance with the Wiring Rules, so the water heater can be switched off.
 - The water heater must be directly connected to the mains power supply.
 - The power supply wires are to be directly connected to the terminal block and earth tab connection, with no excess wire loops inside the front cover. The temperature rating of the power supply wires insulation must suit this application, or the wiring protected by insulating sleeving with an appropriate temperature rating if it can make contact with the internal storage cylinder. The temperature of the internal storage cylinder can reach 60°C under normal operation.
- in compliance with all local codes and regulatory authority requirements.

Installation and commissioning requirements and details for the installing plumber and licensed electrical worker are contained on **pages** 30 to 43.

Mains pressure water supply

The water heater is designed to operate at mains pressure by connecting directly to the mains water supply.

The water heater is supplied with a temperature pressure relief valve with a pressure rating of 1000 kPa. If an expansion control valve has been installed on the cold water line to the water heater, this should have a pressure rating of 850 kPa.

The maximum mains water supply pressure for the water heater is 800 kPa if an expansion control valve is not installed, or 680 kPa if an expansion control valve is installed. If the mains supply pressure in your area exceeds these values, a pressure limiting valve must be installed.

The supply pressure should be greater than 350 kPa for true mains pressure operation to be achieved.

ABOUT YOUR WATER HEATER

WATER HEATER APPLICATION

This water heater is designed for use in a single family domestic dwelling for the purpose of heating potable water. Its use in an application other than this may shorten its life.

MODEL TYPE

Your Everhot® air sourced heat pump water heater is designed for outdoor installation only. The model you have chosen is a 251E280 water heater and is recommended for connection to an uninterrupted 24 hour continuous tariff power supply. Depending upon the size of the household and its hot water requirements and if the Electricity Retailer permits, an extended off-peak (overnight and day) or Extended time-controlled power supply connection of a minimum 16 hours per day may also be suitable.

An Everhot heat pump water heater consumes less energy than an electric water heater. The impact on an electricity account will depend on the tariff arrangement of the water heater replaced and where you live. Contact your energy provider for more information on tariff arrangements and cost comparisons.

The Everhot air sourced heat pump water heater has a vitreous enamel lined steel cylinder. The water heater's evaporator absorbs heat from the surrounding air and transfers this heat into the water.

When hot water is drawn off and cold water enters the tank, a sensor activates a fan, a compressor and the heat pump control system. The fan draws outside air in through the air inlet louvres at the top of the water heater. Heat is absorbed from the air by an evaporator and transferred into the water through a heat exchanger wrapped around the water heater cylinder. The resulting cold air is then discharged through the air outlet louvres back to atmosphere. This process continues while ever heating is required until the water in the storage tank reaches a temperature of 60°C.

Even on cloudy or cold days, heat is drawn from the surrounding air. The heat pump will operate when the ambient air temperature is from -6°C to 43°C. The electric heating unit will operate when the ambient air temperature falls below -6°C or rises above 43°C if heating is required. The efficiency of the heat pump increases as the surrounding ambient air temperature increases.

Automatic safety controls are fitted to the water heater to provide safe and efficient operation.

ELECTRIC BOOSTING

Ice may begin to form on the evaporator reducing the heat pump efficiency, when the ambient air temperature falls below 7°C and the heat pump has been operating for an extended period. If the heat pump operates between -6°C and 7°C for longer than 3 hours 20 minutes, the electric heating unit will turn on to assist in the heating of the water. At ambient air temperatures below -6°C, the water heater deactivates the heat pump operation and switches to the electric heating unit. During these periods the evaporator will defrost if necessary.

When operating at a temperature outside of the heat pump's operating range, the electric heating unit will heat the water in the water heater. The water will be heated to the Hot Water Temperature Set Point.

FREEZE PROTECTION

The water heater has an active de-frost function so the heat pump operates automatically to remove ice which may form on its evaporator coil.

 **Warning:** Do not use any means to accelerate the defrosting process of the evaporator coil or other components of the heat pump.

The water heater also has a freeze protection function built in for extremely cold conditions. When a power supply is available to the water heater and the Display Panel is turned off at the water heater, the electric heating unit will automatically turn on if the water temperature in the water heater falls to 5°C. It will heat the water until the water temperature reaches 10°C and then turn off.



⚠ Warning: In areas where the ambient air temperature may fall below 4°C, power must be available to the water heater at all times.

The water heater has NO WARRANTY for freeze damage if power is unavailable at the water heater.

HOW HOT SHOULD THE WATER BE?

The heat pump is designed to operate until a water temperature of 60°C is reached. If heating is required and the ambient air temperature is outside of the heat pump's operating range, the water temperature is boosted automatically to 60°C by the electric heating unit.

Australian Standard AS/NZS 3500.4 'Plumbing and drainage – Heated water services' requires a water heater to store water at a temperature not less than 60°C or the water heater to satisfy the requirements of Australian Standard AS 3498, to inhibit the growth of legionella bacteria.

If a Timer period is set or the heat pump is connected to an Extended time-controlled power supply, this water heater meets these requirements provided the heat pump is energised for a sufficient period of time each day. Refer to "Timer Control" on page 11.



maximum temperature from heat pump operation and electric heating unit operation;
minimum recommended stored water temperature

maximum recommended supply temperature to bathrooms and ensuite

HOTTER WATER INCREASES THE RISK OF SCALD INJURY

⚠ Warning: This water heater can deliver hot water at temperatures up to 60°C, sufficiently hot to cause severe scalding. Water at this temperature may have been plumbed to fixtures where water hotter than 50°C is allowed, such as the kitchen and laundry.

Check the water temperature before use, such as when entering a shower or filling a bath or basin, to ensure it is suitable for the application and will not cause scald injury.

We recommend and it may also be required by regulations that an approved temperature limiting device be fitted into the hot water pipe work to the bathroom and ensuite when this water heater is installed. This will keep the water temperature below 50°C at the bathroom and ensuite. The risk of scald injury will be reduced and still allow hotter water to the kitchen and laundry.

TEMPERATURE ADJUSTMENT

The thermostat and sensors controlling the heat pump and the electric heating unit are factory set and not adjustable.

DISPLAY PANEL

The water heater has a Display Panel to indicate the status of the water heater. The Display Panel also allows the user to select and use the Timer function. Refer to "Display Panel" on page 14.

TIMER CONTROL

A Timer function on the Display Panel allows the hours of operation of the water heater to be set during one timed period in a 24-hour period. Refer to "Clock and Timer" on page 18.

It may be desirable to operate the water heater during daytime hours when the air temperature is warmer and the heat pump is more efficient, or not to operate between certain hours, such as during peak energy demand periods of a Time of Use electricity supply when more expensive tariffs may apply.

If the water heater is set to run during a timed period, the heat pump and the electric heating unit will not operate outside of this timed period. It is therefore necessary for the hours of operation set by the Timer to be sufficient in each 24-hour period to heat up the full volume of water in the tank from cold to 60°C. The hours of operation sufficient to achieve this will depend on various factors, including the climate and amount of hot water used during the period in which the Timer operates. As a guide, for this water heater this can be up to eight (8) hours in a cold climate in winter (if no hot water is used during this period). If hot water is used, the hours of operation set by the Timer may need to be increased.

Note: If there is a risk of freezing conditions, the electrical supply to the water heater should not be switched off, otherwise damage could result. Refer to "Freeze Protection" on page 10.

PRECAUTIONS

The water heater must be maintained in accordance with the Owner's Guide and Installation Instructions. Refer to "Maintenance Requirements" on page 22 and to "Anode Inspection and Replacement" on page 25.

If this water heater is to be used where an uninterrupted hot water supply is necessary for your application or business you should ensure that you have back-up redundancy within the hot water system design. This should ensure the continuity of hot water supply in the event that this water heater were to become inoperable for any reason. We recommend you seek advice from your plumber or specifier about your needs and building back-up redundancy into your hot water supply system.

TO TURN OFF THE WATER HEATER

If it is necessary to turn off the water heater:

- Switch off the electrical supply at the water heater isolating switch on the switchboard or at the isolating switch at the water heater.
- Close the cold water isolation valve at the inlet to the water heater.

Note: If there is a risk of freezing conditions, the electrical supply to the water heater should not be switched off at the isolating switch, otherwise damage could result. Refer to "Freeze Protection" on page 10.

TO TURN ON THE WATER HEATER

- Open the cold water isolation valve fully on the cold water line to the water heater.
- Switch on the electrical supply at the water heater isolating switch on the switchboard and at the isolating switch at the water heater.
- Check and if required turn the water heater on at the Display Panel.

Note: When the electrical supply is switched on, there will be a knocking sound coming from the heat pump for a short period of time. This is the electronic expansion valve operating. This is normal and not a fault with the heat pump.

HEAT PUMP OPERATION

The heat pump may take up to 5 minutes to commence operating when the power supply is switched on. The heat pump will only operate when:

- power is available at the water heater, and
- the water in the storage tank requires heating, and
- the water temperature in the lower part of the water heater is greater than 11°C below the Hot Water Temperature Set Point.

If the ambient air temperature is below -6°C or above 43°C and the system calls for heating, the heat pump will not operate, and the electric heating unit will operate instead.

When the heat pump is operating, the system may switch to the electric heating unit if it detects that the ambient air temperature is below the minimum operating temperature of -6°C or above the maximum operating temperature of 43°C. It may also switch back to heat pump operation from the electric heating unit if it detects the ambient air temperature has moved back to within the heat pump's operating temperature range.

Note: The heat pump may not turn on after having just completed a heating cycle and more hot water is drawn from the water heater, or whilst the heat pump was operating and either power was switched off or it was turned "Off" at the Display Panel. The heat pump will wait a few minutes before operating and the conditions for start-up are favourable.

GOING ON HOLIDAYS

If you plan to be away from home for a few nights, we suggest you leave the water heater switched on.

If you plan to be away for a longer period, you can conserve energy by turning the water heater off at the Display Panel. The electrical supply remains available to the water heater. The heat pump and electric heating unit are prevented from operating under normal operation. The electric heating unit will operate as part of the freeze protection function if the water in the water heater falls to 5°C. Refer to [“Turn the water heater “Off” at the Display Panel”](#) on page 17 and [“Freeze Protection Function”](#) on page 21.

It is not advised to switch off the water heater at the isolating switch if there is the risk of freeze conditions. Refer to [“To Turn Off The Water Heater”](#) on page 12.

VICTORIAN CUSTOMERS

Notice to Victorian Customers from the Victorian Building Authority. This water heater must be installed by a licensed person as required by the Victorian Building Act 1993.

Only a licensed person will give you a Compliance Certificate, showing that the work complies with all the relevant Standards. Only a licensed person will have insurance protecting their workmanship for 6 years. Make sure you use a licensed person to install this water heater and ask for your Compliance Certificate.

DOES THE WATER CHEMISTRY AFFECT THE WATER HEATER?

The water heater is suitable for most public water supplies, however some water chemistries may have detrimental effects on the water heater, its components and fittings. Refer to [“Water Supplies”](#) on page 24.

If you are in a known harsh water area or you are not sure of your water chemistry, have your water checked against the conditions [described on pages 24 to 26](#).

HOW LONG WILL THE WATER HEATER LAST?

The water heater is supported by a manufacturer’s warranty ([refer to page 4](#)). There are a number of factors that will affect the length of service the water heater will provide. These include but are not limited to the water chemistry, the water pressure, the water temperature (inlet and outlet) and the water usage pattern. Refer to [“Precautions”](#) on page 12.

ENVIRONMENT

At the end of the service life of the heat pump water heater and prior to the water heater being disposed of, a person qualified to work with refrigerants must recover the refrigerant from within the sealed system. The refrigerant must not be vented to atmosphere. Phone Rheem Service or their nearest Accredited Service Agent to arrange for an inspection.

DISPLAY PANEL

DISPLAY PANEL AND ICONS

The water heater has a Display Panel to allow the user to view the current operational status of the water heater and to enable user input functionality.

LEDs on the Display Panel illuminate to display icons when there is power to the water heater and the water heater is turned on at the Display Panel. The display icons provide information on the water heater's current operational status and mode setting, average water temperature in the water heater, usable hot water quantity available, the time, Timer function settings, and fault codes.

The Display Panel also has printed Selection Keys to enable the user to turn the water heater on or off at the Display Panel, set or change the time setting, and set the Timer.

- Refer to [“Display Panel – Display Icons and Selection Keys”](#) on page 15 to view the Display icons and Selection Keys which display on the Display Panel.
- Refer to [“Display Icons and Selection Keys Explained”](#) on page 16 for an explanation of each of the icons and keys.

Memory – The water heater has a memory function. When the electricity supply is switched on to the water heater after having been switched off, or if electricity is reinstated to the water heater after a time controlled electricity supply period, previous settings remain stored. The water heater and heat pump will return to the programmed state at the time the electricity supply being interrupted.

It is necessary to turn the water heater “On” at the Display Panel after the electricity supply is switched on to the water heater at the water heater isolating switch for the first time. The water heater must be “On” at the Display Panel for the heat pump and electric booster unit to operate and heat the water and for the Display icons to illuminate.

FUNCTIONS AND OPERATIONAL MODES OF THE WATER HEATER

Water Temperature Display

The average water temperature in the water heater is displayed in the Main Display Area of the Display Panel. Refer to [“Display Panel – Display Icons and Selection Keys”](#) on page 15 for the Main Display Area.

ECO Mode

This is the standard heating mode. The ECO (Energy Conservation Only) Mode allows the Heat Pump to operate when heating is required, and the ambient temperature is within the heat pump's operating range of -6°C to 43°C. Refer to [“ECO Mode”](#) on page 17.

Useable Hot Water Quantity Display

The Display Panel features a Useable Water Quantity display icon. This icon indicates the quantity of usable hot water in the water heater. Refer to [“Useable Water Quantity Display”](#) on page 18.

Clock and Timer Function

The water heater has a clock function to enable the time to be displayed. It is necessary to set the clock to use the Timer setting function of the water heater.

The Timer function enables one timed period to be set in a 24 hour period. The Timer can be used to control the time of operation of the heat pump.

Refer to [“Clock and Timer”](#) on page 18.

Fault Codes

In the event the water heater develops a fault, a code will display in the Timer / Clock Display Area. This function of the water heater indicates to the user a service call is required. Refer to [“Fault Codes”](#) on page 21.







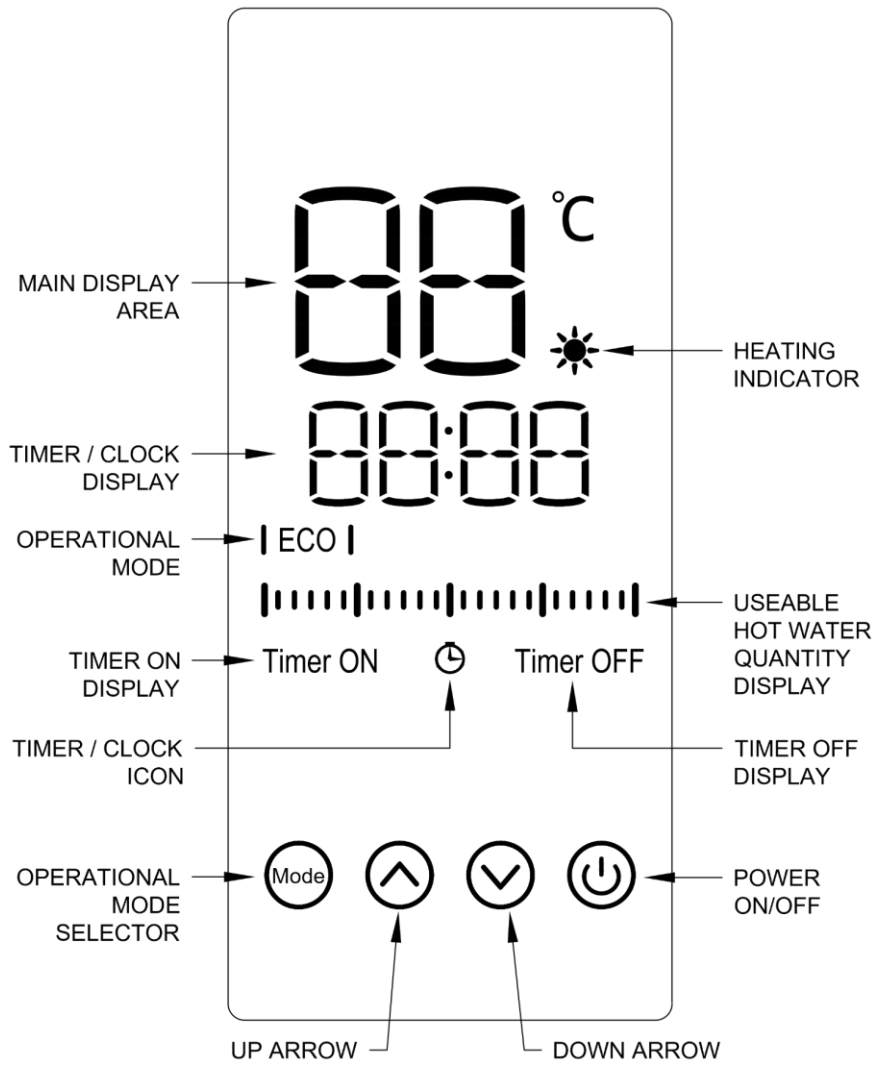



Freeze Protection Function

The water heater has a freeze protection function built in for extremely cold conditions to protect the water heater when the Display Panel is turned off at the water heater. Refer to [“Freeze Protection Function”](#) on page 21.

DISPLAY PANEL – DISPLAY ICONS AND SELECTION KEYS



DISPLAY ICONS AND SELECTION KEYS EXPLAINED

Icon Keys	Description
	On / Off Key: ** used to switch the water heater “On” or “Off” at the Display Panel and to reilluminate the Display Panel fully after it has gone out and become dark..
	Main Display Area: illuminates the Average Water Temperature in the water heater in degrees Celsius. During the setting of the Timer function, it displays 'on' or 'of' depending on whether the Timer ON or Timer OFF time is being set.
	Celsius Icon: illuminates when the Main Display Area displays the Average Water Temperature.
	Heating Indicator Icon: illuminates solid when heating of the water is taking place by the heat pump in ECO Mode or flashing when the electric heating unit is operating without the heat pump.
	Timer / Clock Display Area: displays the time or the Timer ON or Timer OFF setting, depending upon the operational status of the water heater. A Fault Code is displayed here if the water heater were to develop a fault.
	ECO (Energy Conservation Only) Mode Icon: This is the standard heat pump heating mode.
	Useable Hot Water Quantity Display Icon: illuminates to display the quantity of usable hot water in the water heater. The number of bars illustrates the average water temperature in the water heater calculated from the water temperature in both the upper part and lower part of the water heater.
	Timer / Clock Icon: illuminates when a Timer period is set.
Timer ON	Timer On Display: illuminates when the Timer ON period is being set.
Timer OFF	Timer Off Display: illuminates when the Timer OFF period is being set.
	Operational Mode Selector Key: This key is used to enter or leave the Clock setting function, and Timer ON and Timer OFF setting functions.
	Up Arrow Key: used to increase the time values during the Clock and Timer setting functions.
	Down Arrow Key: used to decrease the time values during the Clock and Timer setting functions.

**** Note – On / Off Key:** The On / Off key only turns the Heat Pump and electric heating unit “Off” at the Display Panel. It does not switch off or isolate the electricity supply to the water heater or Display Panel. If it is necessary to switch off the electricity supply to the water heater, then this must be done at the water heater isolating switch on the switchboard or at the isolating switch adjacent to the water heater.

TURNING THE WATER HEATER “ON” OR “OFF” AT THE DISPLAY PANEL

Turn the water heater “On” at the Display Panel

- When the water heater is “Off” at the Display Panel, press the “On / Off” key to turn the water heater “On” at the Display Panel.

The average water temperature in the water heater illuminates in the Main Display Area.

The time (if set) illuminates in the Timer / Clock Display Area.

The ECO Operational Mode icon illuminates.

The Useable Water Quantity icon bars illuminate (if the water is hot).

The Timer / Clock icon illuminates if the Timer is set.

The Display Panel will remain fully illuminated for one (1) minute if a key is not pressed or after a key is pressed. It will then go out and become dark.

Note: When the water heater is turned on at the Display Panel after the electrical supply is switched on at the isolating switch, there may be a knocking sound coming from the heat pump for a short period of time. This is the electronic expansion valve operating. This is normal and not a fault with the heat pump. This knocking sound may also occur when the water heater is reconnected to power from a time controlled electrical supply after having been off.

Reilluminating the Display Panel

- To reilluminate the Display Panel fully after it has gone out, press the “On / Off” key.

Turn the water heater “Off” at the Display Panel

- When the water heater is “On” at the Display Panel, press and hold the “On / Off” key for more than four (4) seconds to turn the water heater “Off” at the Display Panel.

Holding the “On / Off” key for less than four (4) seconds, leaves the water heater turned “On”.

The average water temperature display in the Main Display Area goes out.

The Time display and ECO Operational Mode icon go out.

The Useable Water Quantity icon bars go out.

Note: If the Display Panel is in a ‘dark’ state, i.e. the Display Panel is out, it will be necessary to press the “On / Off” key twice. The first press reilluminates the Display Panel fully, the second press turns off the water heater at the Display Panel.

ECO MODE

The ECO (Energy Conservation Only) Mode is the standard day to day operational and heating mode by the heat pump. This mode allows for the Heat Pump to operate during normal operation when heating is required. The ECO icon illuminates on the Display Panel.

The heat pump will operate when there is:

- electricity supply to the water heater, and
- the water heater is turned “On” at the Display Panel, and
- the water temperature in the lower part of the water heater is greater than 11°C below the Hot Water Temperature Set Point, and
- the ambient temperature is between the heat pump’s operating range of -6°C to 43°C.

 The image shows the ECO icon, which consists of the letters "ECO" in a bold, sans-serif font, enclosed within a vertical rectangular frame on the left side.

If the heat pump operates between -6°C and 7°C for an extended period of time, the electric heating unit may turn on to assist in the heating of the water.

The electric heating unit will operate if the ambient air temperature is outside of the heat pump’s operating range of -6°C to 43°C and heating of the water is required.

USEABLE HOT WATER QUANTITY DISPLAY

The Display Panel features a Useable Hot Water Quantity display icon. This icon indicates the quantity of usable hot water in the water heater. The more bars illuminated, the more hot water there is available.

The display ranges from no illumination of bars, which indicates the average temperature of the water in the water heater is below 36°C, to the illumination of twenty five bars, which indicates the water heater is full of hot water. The number of bars illustrate the average water temperature in the water heater calculated from the water temperature in both the upper part and lower part of the water heater. It is an approximation only.



Useable Hot Water Quantity Display

The first solid vertical bar represents an average tank temperature of 36°C. Each subsequent solid bar represents an increase of average water temperature in the water heater by 1°C. When all 25 bars are illuminated solid, the average tank temperature is 60°C or above. It may be above 60°C if the Hot Water Temperature Set Point is greater than 60°C.

Whilst the water heater is heating water, the illuminated bars will fluctuate back and forth from left to right.

CLOCK AND TIMER

Clock

The water heater has a clock function. The clock must be set in order to use the Timer setting function of the water heater.

The setting of the clock includes hours and minutes only. It does not include day, month, or year. Once the clock is set, the time in hours and minutes is displayed in the Timer / Clock Display when the water heater is "On" at the Display Panel.

The clock is a 24 hour clock, i.e. if the time is 4:30PM, it will show as 16:30 on the clock.

Timer

The water heater has a Timer function. One timed period can be set within a 24 hour period. The Timer operates over a 24 hour period, it does not allow for days or months to be programmed.

The Timer is used in conjunction with the ECO Mode to control the times of operation of the heat pump. The heat pump and the electric heating unit will not operate outside of this timed period under ECO Mode operation.

It may be desirable to operate the water heater during daytime hours when the air temperature is warmer and the heat pump is more efficient, or not to operate between certain hours, such as during peak energy demand periods of a Time of Use electricity supply when more expensive tariffs may apply.

The Timer displays use a 24 hour clock, i.e. if the time being set is 4:30PM, it will show as 16:30.

Notes

- If a Timer period is not set, the Timer / Clock icon does not illuminate.
- It is necessary for the hours of operation set by the Timer to be sufficient to heat up the full volume of water in the tank from cold to its set point of 60°C, to ensure the hot water consumption requirements of the household are met. The hours of operation sufficient to achieve this will depend on various factors, including the climate and amount of hot water used during the period in which the Timer operates. The heat pump will take longer to heat water in the cooler winter months than in the warmer summer months. As a guide, for this water heater this can be up to eight (8) hours in a cold climate in winter (if no hot water is used during this period). If hot water is used, the hours of operation set by the Timer may need to be increased.
- The Timer period may need to be reset at the start and finish of Daylight Saving.
- The clock and Timer period can only be set when the water heater is "Off" at the Display Panel.
- If the Timer OFF setting is earlier in the day than the Timer ON setting, then the Timer will turn OFF the following day.

- If the Timer is set and the scheduled power ON and scheduled power OFF times are the same, the scheduled power OFF setting will over-ride the scheduled power ON setting. The heat pump will remain off and will not operate. The Display Panel and Timer / Clock icon will remain illuminated.
- If there is no action for 10 seconds during the setting of the Clock or the Timer period, the Display Panel exits the clock or Timer programming. The last programmed Clock time or Timer setting will be saved.

To set the Clock

1. Turn the water heater “Off” at the Display Panel.

- Press the “On / Off” key.



The displays and icons go out. The Display Screen is blank.

Note: If the Display Panel is in the ‘dimmed’ state, it will be necessary to press the “On / Off” key twice. The first press reilluminates the Display Panel fully, the second press turns off the water heater at the Display Panel.

2. Activate the Clock setting screen.

- Press the “MODE” key 3 times.

A beeping sound will be heard with each press of the key. If the beeping sound is not heard at the press of the key, then press the key again. Use the sound feedback to help with the press count.



The current Time setting illuminates in the Timer / Clock Display and the hour digits commence to flash.



A colon separates the hour digits (on left) and minute digits (on right) on the display.

3. Set the Clock time.

- Press the "Up" key or "Down" key to select the hour digits.



- Press the “Mode” key to save the hour digits.

The minute digits commence to flash.



- Press the "Up" key or "Down" key to select the minute digits.

- Press the “Mode” key to save the minute digits.



Note: The display switches to the Timer setting.

Proceed to Step 1 if a Timer period is to be set.

Either ‘oN’ or ‘oF’ will flash in the Main Display Area. The Timer / Clock icon will also flash.

If a Timer period is not to be set and ‘oN’ is flashing in the Main Display area, then:

- Press the “Down” key.

‘oF’ will commence flashing in the Main Display Area.

- Press the “Mode” key.

The ‘oF’ icon goes out and the Display Panel is blank.



The water heater remains “OFF” at the Display Panel. It will be necessary to turn the water heater “ON” again at the Display Panel.

To set the Timer

1. Set the Timer ON time.

If a Timer period is to be set and 'oF' is flashing in the Main Display area, then:

- Press the "Up" key.

'oN' will commence flashing in the Main Display Area.

- Press the "Mode" key.

The hour digits flash in the Timer / Clock Display Area.

The Timer ON and Timer / Clock icons illuminate and flash.

- Press the "Up" key or "Down" key to select the hour digits.

- Press the "Mode" key to save the hour digits.

The minute digits commence to flash.

- Press the "Up" key or "Down" key to select the minute digits.

- Press the "Mode" key to save the minute digits.

The Timer ON icon goes out.

The Timer OFF and Timer / Clock icons illuminate and flash.

The hour digits flash in the Timer / Clock Display Area.



2. Set the Timer OFF time.

- Press the "Up" key or "Down" key to select the hour digits.

- Press the "Mode" key to save the hour digits.

The minute digits commence to flash.

- Press the "Up" key or "Down" key to select the minute digits.

- Press the "Mode" key to save the minute digits.

The Display returns to an off state. The displays and icons go out. The Display Screen is blank.

3. Turn the water heater "On" at the Display Panel

- Refer to "Turn the water heater "On" at the Display Panel" on page 17.

To turn the Timer Function Off

To turn the Timer function off, so power is available to the heat pump 24 hours a day:

4. Turn the water heater "Off" at the Display Panel and activate the Clock setting screen.

- Follow Steps 1 and 2 of the procedure "To Set the Clock" on page 19.

The hour digits in the Timer / Clock Display commence to flash.

5. Turn the Timer Function off.

- Press the "Mode" key.

The minute digits commence to flash.

- Press the "Mode" key a second time.

The Timer / Clock Display goes out.

'oN', displayed in the Main Display Area, and the Timer / Clock icon both commence to flash.

If 'oF' is flashing in the Main Display Area instead of 'oN', there is no need to press the "Down" key.

- Press the "Down" key.

'oF' flashes in the Main Display Area and the Timer / Clock icon continues to flash.

- Press the "Mode" key a third time.

The Timer / Clock icon and 'oF' in the Main Display Area go out and the Display Panel is blank.

The Timer is no longer set.

The water heater remains "OFF" at the Display Panel. It will be necessary to turn the water heater "ON" again at the Display Panel.



FAULT CODES

A fault code will display in the Timer / Clock Display Area in the event the water heater develops a fault. In addition, a one off six (6) second beeping alarm will sound from the Display Panel if a fault code is displayed.

The fault code will display alternately with the current time display. If there is more than one fault code, each code will display alternately with the other fault code(s) and the current time display.

The fault codes which may appear are:

- **F01, F02, F03, F04, F05, F06, F07, F08** – The heat pump will not operate. The electric heating unit will operate to heat the water when heating is required, to provide hot water until a service call is made to repair the fault.
- **F10, F11** – The electric heating unit will not operate. The heat pump will operate to heat the water when heating is required. A service call is required to repair the fault.
- **F09, F13** – The heat pump and electric heating unit will not operate and there will be no heating of the water.
- **F12** – The heat pump and electric heating unit will not operate. This is an over-temperature fault which will reset when the hot water in the bottom two thirds of tank is either replaced with cold water as hot water is drawn off, or the water temperature reduces through tank heat loss. If the fault reoccurs, a service call must be made.

If one or more of the above codes is displayed on the Display Panel, make a note of the fault code(s) and phone Rheem Service or their nearest Accredited Service Agent to arrange for an inspection.

FREEZE PROTECTION FUNCTION

The water heater has a freeze protection function built in to protect the water heater in extremely cold conditions and the water temperature in the water heater falls to 5°C. This condition will only occur if the Display Panel is turned off at the water heater. The power supply to the water heater must be turned on at the isolating switch and power must be available to the water heater.

The electric heating unit will automatically turn on if the water temperature in the water heater falls to 5°C. It will heat the water until the water temperature reaches 10°C and then turn off.

The code **Fd** and the Heating Indicator Icon will illuminate solid in the Display area of the Display Panel.

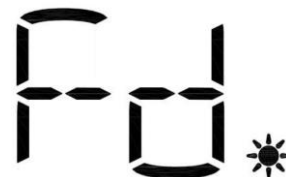

MAINTENANCE REQUIREMENTS

MINOR MAINTENANCE EVERY SIX MONTHS

It is recommended minor maintenance be performed every six (6) months. Minor maintenance can be performed by the dwelling occupant.

Switch off the electrical supply at the power outlet to the water heater prior to performing general maintenance. This will prevent the water heater from operating while you clean or spray around the water heater. Switch on the electrical supply at the power outlet to the water heater when finished performing the general maintenance.

The minor maintenance includes:

- Operate the easing lever on the temperature pressure relief valve. **It is very important the lever is raised and lowered gently.** Refer to “Relief Valves” on page 8.

⚠ Warning: Water discharged from the temperature pressure relief valve drain line will be hot. Exercise care to avoid any splashing of water by standing clear of the drain line’s point of discharge when operating the valve’s easing lever.

- Operate the easing lever on the expansion control valve. **It is very important the lever is raised and lowered gently.** Refer to “Relief Valves” on page 8.

If water does not flow freely from the drain line of either the temperature relief valve or expansion control valve when the easing lever is operated, phone Rheem Service or their nearest Accredited Service Agent to arrange for an inspection.

- The jacket of the water heater can be cleaned with a soft cloth and warm mild soapy water if required. Under no circumstances should abrasive materials or powders be used.

- Inspect around the air inlet and outlet louvres and the water heater in general for plant growth.

- Trim back any shrubs, bushes or other plants which have encroached around the water heater.

Plant growth across the air inlet and outlet louvres can interfere with the performance of the water heater.

- Inspect around the water heater for infestations of insects, such as ants. Insects encroaching into or nesting in the water heater can interfere with the operation of the water heater and also damage components. The area around the water heater can be sprayed with insecticide to rid the area of insects.

⚠ Warning: Do not spray insecticide near the water heater while the heat pump is operating.

- If necessary to rid the area of insects:

- Ensure the electrical supply at the power outlet to the water heater has been switched off.

- Spray the affected area, taking care not to spray into the air inlet or outlet louvres or onto the surface of the water heater.

- Wait a few minutes to allow any aerosol gases to dissipate before switching on the electrical supply at the power outlet to the water heater.

- Inspect and check the condensate drain hose.

- Remove the drain hose from the drain spigot towards the rear of the heat pump. Use a garden hose to run water through the drain hose and dislodge any foreign bodies. Reconnect the drain hose to the drain spigot. Ensure the garden hose and drain hose are well clear of the heat pump and its components.

- Clear away any build-up or snow or ice from around the water heater.

MAJOR SERVICE EVERY FIVE YEARS

It is recommended a major service be conducted on the water heater every five (5) years.

⚠ Warning: Servicing of a water heater must only be carried out by qualified personnel. Phone Rheem Service or their nearest Accredited Service Agent.

Note: The major service and routine replacement of any components, such as the anode and relief valve(s), are not included in the Everhot warranty. A charge will be made for this work. Only genuine replacement parts should be used on this water heater. This service does not involve accessing the refrigerant circuit (sealed system).

The major service includes:

- Replace the temperature pressure relief valve.
- Inspect and flush the expansion control valve (if fitted). If required, replace the valve.
- Inspect and if required, replace the anode.

If the anode is not replaced, it should be replaced within three years of this service.

Refer to **"Anode Inspection and Replacement"** on page 25.

- Check the electric heating unit for excessive calcium build-up or corrosion and replace if necessary.
- Flush the water heater tank (if required).
- Check and clean the heat pump of dust and residue.
- Check and inspect the heat pump for operation.
- Visually check the unit for any potential problems.
- Inspect all connections.
- Inspect around the air inlet and outlet louvres and the water heater in general for plant growth.
- Inspect around the water heater for infestations of insects, such as ants.
- Inspect and check the condensate drain hose.
- Check the items covered in the minor maintenance

Note: The water heater may need to be drained during this service. After the completion of the service, the water heater will take some time to reheat the water. Depending upon the power supply connection, hot water may not be available until the next day.

HEAT PUMP SYSTEM

It is recommended the evaporator and refrigeration system is checked every five years. In particularly dusty environments, it may be necessary to have the heat pump system checked and cleaned of dust and residue on a more regular basis. This must only be conducted by qualified personnel.

WATER SUPPLIES

This water heater must be installed in accordance with this advice to be covered by the Everhot warranty.

This water heater is manufactured to suit the water conditions of most public reticulated water supplies. However, there are some known water chemistries which can have detrimental effects on the water heater and its operation and / or life expectancy. If you are unsure of your water chemistry, you may be able to obtain information from your local water supply authority. This water heater should only be connected to a water supply which complies with these guidelines for the Everhot warranty to apply.

CHANGE OF WATER SUPPLY

The changing or alternating from one water supply to another can have a detrimental effect on the operation and / or life expectation of a water heater cylinder, a temperature pressure relief valve and a heating unit.

Where there is a changeover from one water supply to another, e.g. a rainwater tank supply, bore water supply, desalinated water supply, public reticulated water supply or water brought in from another supply, then water chemistry information should be sought from the supplier or it should be tested to ensure the water supply meets the requirements given in these guidelines for the Everhot warranty to apply.

ANODE

The vitreous enamel lined cylinder of the water heater is only covered by the Everhot warranty when the total dissolved solids (TDS) content in the water is less than 2500 mg/L and when the correct colour coded anode is used. If an incorrect colour coded anode is used in the water heater, any resultant faults will not be covered by the Everhot warranty. In addition, the use of an incorrect colour coded anode may shorten the life of the water heater cylinder.

The correct colour coded anode is as shown in the following table:

Total Dissolved Solids	Anode colour code
0 – 40 mg/L	Green
40 – 150 mg/L	Green or Black
150 – 400 mg/L	Black
400 – 600 mg/L	Black or Blue
600 – 2500 mg/L	Blue
2500 mg/L +	Blue (no cylinder warranty)

The changing of anodes must be carried out by a qualified person.

Note: Some water analysis reports may state the conductivity of the water rather than the level of total dissolved solids. Conductivity, measured in microsiemens per centimetre ($\mu\text{S} / \text{cm}$), is directly proportional to the TDS content of the water. TDS, in mg / L, is approximately 70% of the conductivity in $\mu\text{S} / \text{cm}$.

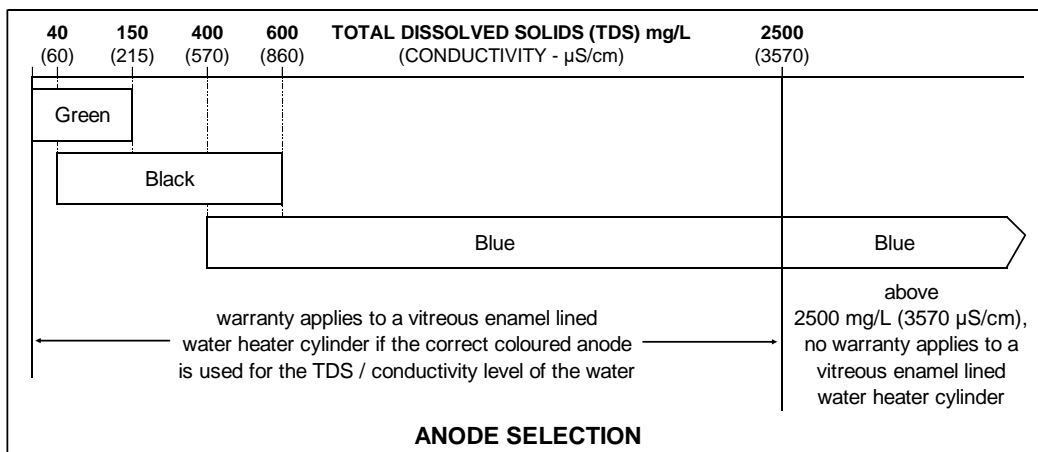

ANODE INSPECTION AND REPLACEMENT

The anode installed in your water heater will slowly dissipate whilst protecting the cylinder. The life of the cylinder may be extended by replacing the anode.

For water supplies which are either softened or desalinated, or where the water supply may alternate between a water tank and a reticulated public supply or another supply, or where there is a variable supply (e.g. from a bore or public reticulated supply from various water sources), the anode must be inspected (and replaced if there is any sign of depletion) within five (5) years of its installation.

For all water supplies, if the anode is not replaced during a major service (refer to “**Major Service Every Five Years**” on page 23) then the maximum time after installation when the anode should be replaced for this water heater is eight (8) years.

CAUTION

If the water supply has a TDS greater than 150 mg/L and a green anode has not been changed to a black anode, or if the TDS is greater than 600 mg/L and the anode has not been changed to a blue anode, there is the possibility the anode may become overactive and hydrogen gas could accumulate in the top of the water heater during long periods of no use.

If, under these conditions, the water heater has not been used for two or more weeks the following procedure should be carried out before using any electrical appliances (automatic washing machines and dishwashers) which are connected to the hot water supply.

The hydrogen, which is highly flammable, should be vented safely by opening a hot tap and allowing the water to flow. There should be no smoking or naked flame near the tap whilst it is turned on. Any hydrogen gas will be dissipated. This is indicated by an unusual spurting of the water from the tap. Once the water runs freely, any hydrogen in the system will have been released.

SATURATION INDEX

The saturation index (SI) is used as a measure of the water's corrosive or scaling properties. The saturation index figures stated are calculated using a water temperature of 80°C.

In a corrosive water supply, the water can attack copper parts and cause them to fail. Where the saturation index is less than -1.0, the water is very corrosive, and the Everhot warranty does not apply to a copper sheathed heating unit. A corrosion resistant heating unit must be used for the Everhot warranty to apply to the heating unit.

In a scaling water supply calcium carbonate is deposited out of the water onto any hot metallic surface. Where the saturation index exceeds +0.40, the water is very scaling. An expansion control valve must be fitted on the cold water line after the non-return valve to protect and for the Everhot warranty to apply to the temperature pressure relief valve and water heater cylinder.

Where the saturation index exceeds +0.80, the Everhot warranty does not apply to a standard watts density heating unit. A low watts density heating unit must be used for the Everhot warranty to apply to the heating unit.

Water which is scaling may be treated with a water softening device to reduce the saturation index of the water.

Refer to the **Saturation Index chart** on page 26. Refer to the **cold water connection diagram** on page 37 for the position of the expansion control valve.

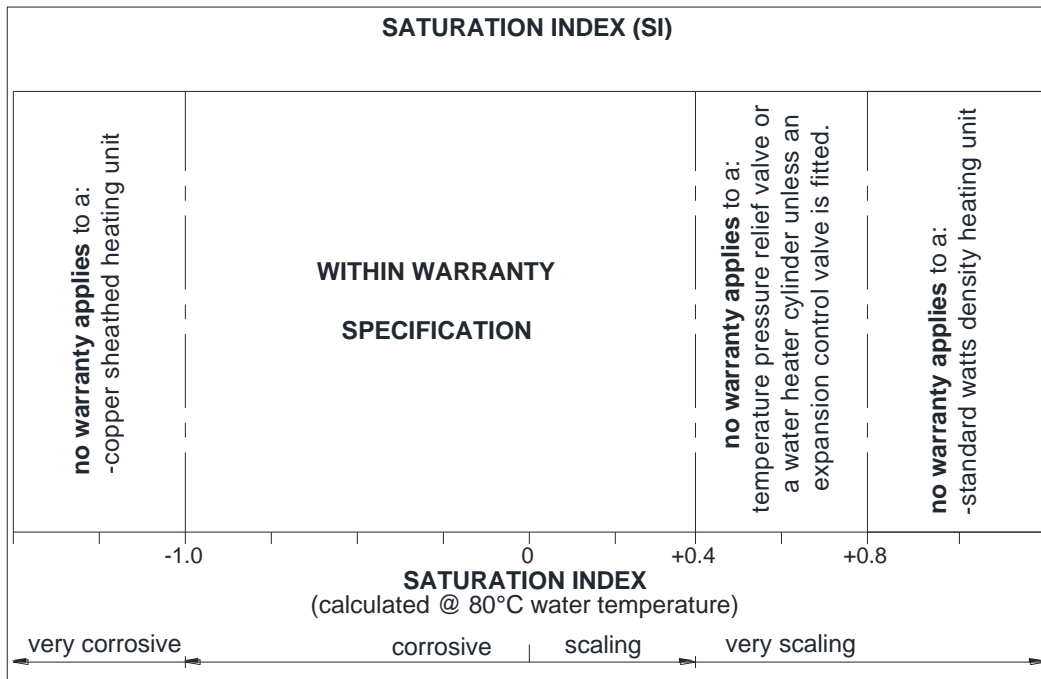

SUMMARY OF WATER CHEMISTRY ADVICE AFFECTING WARRANTY

The water heater is not suitable for certain water chemistries. Those chemistries are listed below. If the water heater is connected at any time to a water supply with the following water chemistry, the Everhot warranty will not cover any resultant faults:

Water Chemistry

- Total Dissolved Solids (TDS) > 2500 mg/L
- Total Dissolved Solids (TDS) not suitable for anode type
- Saturation Index (SI) < -1.0
- Saturation Index (SI) > +0.4 (if expansion control valve is not fitted)
- Saturation Index (SI) > +0.8

Component

- water heater cylinder
- water heater cylinder
- copper sheathed heating unit
- water heater cylinder
- temperature pressure relief valve
- standard watts density heating unit

SAVE A SERVICE CALL

Check the items below before making a service call. You will be charged for attending to any condition or fault that is not related to manufacture or failure of a part.

NOT ENOUGH HOT WATER (OR NO HOT WATER)

- **Is the electricity switched on?**

Inspect the isolating switch marked “HOT WATER” or “WATER HEATER” at the switchboard and the isolating switch at the water heater and ensure they are turned on.

Check the fuse or circuit breaker marked “HOT WATER” or “WATER HEATER” at the switchboard.

- **Has the Timer been set?**

If the Timer has been set, ensure sufficient time has been allowed to reheat the storage tank.

- **Are you using more hot water than you think?**

Is one outlet (especially the shower) using more hot water than you think?

Very often it is not realised the amount of hot water used, particularly when showering. Carefully review the family’s hot water usage. As you have installed an energy saving appliance, energy saving should also be practised in the home.

Adjust your water usage pattern to take advantage of maximum energy gains. Have your plumber install a flow control valve to each shower outlet to reduce water usage.

- **Heat pump fault**

Is the ‘F09’ or ‘F13’ fault code displayed on the Display Panel? The heat pump has developed a fault.

The heat pump and electric heating unit will not operate and there will be no heating of the water. Phone Rheem Service or their nearest Accredited Service Agent to arrange for an inspection.

Refer to “**Fault Codes**” on page 21.

Also refer to “**Heat Pump Is Not Operating**” on page 28.

- **Relief valve running**

Is the relief valve discharging too much water?

Refer to “**Temperature Pressure Relief Valve or Expansion Control Valve Running**” on page 28.



WATER NOT HOT ENOUGH

You may find that due to heavy hot water usage the water temperature may be lower than normally expected, due to insufficient heating time being allowed. You will need to carefully plan your use of the hot water on such occasions.

WATER TOO HOT

The heat pump and electric heating unit operation will heat the water to a temperature of 60°C. This is normal operation.

If the water heater Display Panel shows a fault code ‘F12’, this indicates the water heater has developed an over-temperature fault. The water would have been heated to 85°C. The water heater will reset when the water in the bottom two thirds of tank is replaced with cold water as hot water is drawn from the water heater.

If the fault reoccurs, a service call must be made. Refer to “**Fault Codes**” on page 21.

Phone Rheem Service or their nearest Accredited Service Agent to arrange for an inspection.

HEAT PUMP IS NOT OPERATING

- **Power must be available at the water heater and the water heater switched on.**
If there is power to the water heater, check the water heater has been turned “On” at the Display Panel. Refer to “Turning the Water Heater “On” or “Off” at the Display Panel” on page 15.

- **Time controlled power supply**
If the water heater is connected to a time controlled power supply, then during periods of no power supply at the water heater, the heat pump and electric heating unit will not operate.

This is not a fault condition, but a result of no power being available to operate the water heater.

Check the hours of supply from the electricity retailer.

The Display Panel will illuminate again when power is available again at the water heater.

Note: If power was cut to the heat pump whilst it was operating, it may wait for a few minutes before recommencing to operate when power is restored and if heating is required.

- **Heat pump operating range**
The heat pump’s operating range is when the ambient air temperature is from -6°C to 43°C. It will not operate outside of this temperature range.

The electric heating unit will operate if the ambient air temperature is outside of the heat pump’s operating range and heating of the water is required.

The water in the water heater will be heated to the Hot Water Temperature Set Point.

- **Possible fault condition**
If the heat pump has developed a fault with a fault code of F01 to F09, F12 or F13, the heat pump will not operate, and the fault code will be displayed on the Display Panel in the Timer / Clock Display Area. In this condition and depending upon the fault code, if heating of the water is required, the electric heating unit will operate automatically to heat the water in the water heater. Refer to “Fault Codes” on page 21.

Take note of the fault code and phone Rheem Service or their nearest Accredited Service Agent to arrange for an inspection.

TEMPERATURE PRESSURE RELIEF VALVE OR EXPANSION CONTROL VALVE RUNNING

- **Normal Operation**
It is normal and desirable the temperature pressure relief valve or expansion control valve (if fitted) allows a quantity of water to escape during the heating cycle. This quantity should be equal to approximately 1/50 of the hot water used, as water expands by this volume when heated. However, if it discharges more than a bucket full of water in 24 hours, there may be another problem.

The expansion control valve (if fitted) will discharge water instead of the temperature pressure relief valve as it has a lower pressure rating. A benefit is that energy is conserved as the discharged water is cooler. This valve is installed in the cold water line to the water heater.

Refer to the [cold water connection diagram](#) on page 37.

- **Continuous dribble**
Try gently raising the easing lever on the relief valve for a few seconds (refer to “Relief Valves” on page 8). This may dislodge a small particle of foreign matter and clear the fault. Release the lever gently.

- **Steady flows for long periods (often at night)**
This may indicate the mains water pressure sometimes rises above the designed pressure of the water heater. Ask your installing plumber to fit a pressure limiting valve.

⚠ Warning: Never replace the relief valve with one of a higher pressure rating.

- **Heavy flows of hot water from the temperature pressure relief valve until the water heater is cold - then stops until water reheats**
The water heater **must** be switched off at the isolating switch or switchboard. Phone Rheem Service or their nearest Accredited Service Agent to arrange for an inspection.

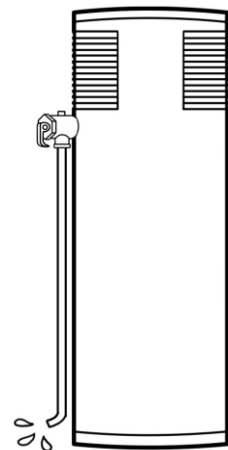

HIGHER THAN EXPECTED ELECTRICITY BILLS

With the installation of your new air sourced heat pump water heater, electrical energy savings can be achieved. Should you at any time, feel your electricity bill is higher than expected, we suggest you check the following points:

- Is the water heater operating for extended periods with the electric heating unit?

Prolonged periods of use where the ambient air temperature is outside of the heat pump's operating range when heating is required will increase the amount of heating required by the electric heating unit to ensure a supply of hot water, increasing running costs.

Refer to **"Heat Pump Is Not Operating"** on page 28.

- Has the water heater developed a fault?

Check if an error code is displayed on the Display Panel. If the water heater has developed a fault, it may be operating with the electric heating unit only, which will increase the amount of purchased energy used.

Refer to **"Fault Codes"** on page 21.

- Is the relief valve running excessively?

Refer to **"Temperature Pressure Relief Valve or Expansion Control Valve Running"** on page 28.

- Is one outlet (especially the shower) using more hot water than you think?

Refer to **"Not Enough Hot Water"** on page 27.

- Is there a leaking hot water pipe, dripping hot water tap, etc?

Even a small leak will waste a surprising quantity of hot water and energy. Replace faulty tap washers, and have your plumber rectify any leaking pipe work.

- Has there been an increase in hot water usage?

An increase in hot water usage will result in an increase in heat pump operation.

- Has your water heating tariff rate been increased by your electricity retailer since your previous bill?

- Is the heat pump water heater on the same tariff as the water heater replaced?

The impact on an electricity account will depend upon the tariff arrangement of the water heater replaced and where you live. Contact your energy provider for more information on tariff arrangements and cost comparisons.

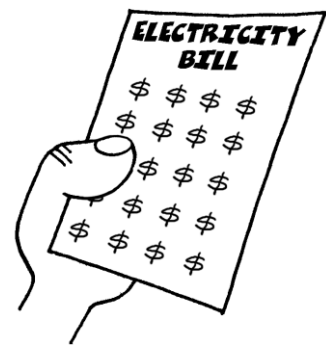

IF YOU HAVE CHECKED ALL THE FOREGOING AND STILL BELIEVE YOU NEED ASSISTANCE, PHONE RHEEM SERVICE OR THEIR NEAREST ACCREDITED SERVICE AGENT.

INSTALLATION

**THIS WATER HEATER IS FOR OUTDOOR INSTALLATION ONLY.
THIS WATER HEATER IS NOT SUITABLE FOR POOL HEATING.**

INSTALLATION STANDARDS

The water heater must be installed:

- by a qualified person, and
- in accordance with the installation instructions, and
- in compliance with the Plumbing Code of Australia, and
- in compliance with the Australian / New Zealand Wiring Rules AS/NZS 3000, and
- in compliance with all local codes and regulatory authority requirements.

During the installation and commissioning process, it is not necessary to access the sealed refrigerant system, which contains a flammable refrigerant. Therefore, the water heater can be installed by a suitably qualified plumber and electrical worker.

⚠ Warning: This water heater may deliver water at high temperature. Refer to the Plumbing Code of Australia, local requirements and these installation instructions to determine if additional delivery temperature control is required. Refer to “[Hot Water Delivery](#)” on page 33.

Victorian Installers

Notice to Victorian Installers from the Victorian Building Authority if this solar water heater is installed in a new Class 1 dwelling in the State of Victoria. The system model number is to be recorded on the Certificate of Compliance.

It is also a requirement to provide the householder with permanent documentation recording the system model number exactly as it is shown in the ‘VEET Product Register’ published by the Essential Services Commission in Victoria. See www.veu-registry.vic.gov.au/Public/ProductRegistrySearch.aspx. This documentation may be in the form of an indelible label adhered to the heat pump storage tank, or other suitable form placed in an accessible location, such as the meter box, for later inspection.

WATER HEATER APPLICATION

This water heater is designed for use in a single family domestic dwelling for the purpose of heating potable water. Its use in an application other than this may shorten its life.

If this water heater is to be used where an uninterrupted hot water supply is necessary for the application or business, then there should be back-up redundancy within the hot water system design. This should ensure the continuity of hot water supply in the event that this water heater was to become inoperable for any reason. We recommend you provide advice to the system owner about their needs and building back-up redundancy into the hot water supply system.

The water heater is recommended for connection to an uninterrupted 24 hour continuous tariff power supply. Depending upon the size of the household and its hot water requirements and if the Electricity Retailer permits, an extended off-peak (overnight and day) or Extended time-controlled power supply connection of a minimum 16 hours per day may also be suitable.

An Everhot heat pump water heater consumes less energy than an electric water heater. The impact on an electricity account will depend on the tariff arrangement of the water heater replaced and the installation location. Contact the energy provider for more information on tariff arrangements and cost comparisons.

TRANSPORTING AND HANDLING THE WATER HEATER

Take care when handling the water heater. The jacket surrounding the heat pump at the top of the water heater needs to be handled gently so as not to cause damage.

Do not tilt the water heater more than 30° from the vertical. Care must be taken during transportation and handling as the water heater is top heavy. It will become unstable if tilted more than 30° from the vertical. The water heater must be secured during transport to avoid tipping over. To prevent injury or damage, the water heater must also be placed on a level surface.

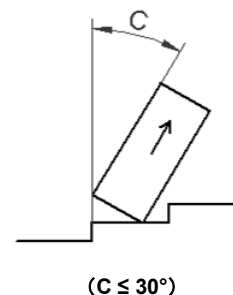

In addition, tilting the water heater more than 30° from the vertical during handling will unsettle the refrigerant gas and compressor lubricating oil. If the water heater has been tilted, it will need one hour to settle before the power to the water heater can be switched on, otherwise damage to the compressor may result.

All packaging materials must be removed from the water heater prior to its installation. This includes the removal of the packaging base of the carton from the underside of the water heater.

WATER HEATER LOCATION

The water heater is suitable for outdoor installation only. The water heater should be installed close to the most frequently used outlet and its position chosen with noise, safety and service in mind. Make sure people (particularly children) will not accidentally touch the air inlet and outlet louvres and that they are clear of obstructions and shrubbery.

It is advisable to install the water heater away from bedroom or living room windows as the system controls can generate a level of noise whilst they are operating. Consider the location in relation to neighbours' bedrooms and living room windows.

Clearance must be allowed for servicing of the water heater. The water heater must be accessible without the use of a ladder or scaffold. Make sure the temperature pressure relief valve lever is accessible and the top and front cover, air inlet and outlet louvres, system controls and thermostat can be removed for service.

To maintain the designed performance, air flow and air discharge from the heat pump, and service access, the minimum distances to a wall or obstruction from the water heater are:

- 25 mm from a wall behind the water heater, and
- 350 mm on the left hand side from the air inlet louvre, and
- 1,000 mm on the right hand side from the air outlet louvre.

It is recommended to leave a minimum distance of 900 mm in front of and to the left hand side of the water heater, where this is possible, for service access. Refer to the [dimensions diagram](#) on page 34.

You must be able to read the information on the rating plate. If possible, leave headroom of one water heater height so the anode can be inspected or replaced. Remember you may have to remove the entire water heater later for servicing.

The heat pump water heater is to be installed at ground or floor level and must stand vertically upright on a level, stable and impervious base designed to avoid ponding in accordance to AS/NZS 3500.4 and as acceptable to local authorities. The base of the water heater is made of corrosion resistant material, and it may be placed directly in contact with the supporting surface. It is not necessary to allow for free air circulation under the base of the water heater.

Note: The water heater should not be placed in direct contact with a concrete surface that is less than two months old and not fully cured as this may attack the metal coating of the water heater base. A moisture barrier should be used between the two surfaces in this instance. The barrier should extend at least 100 mm from the water heater and may be trimmed after two months.

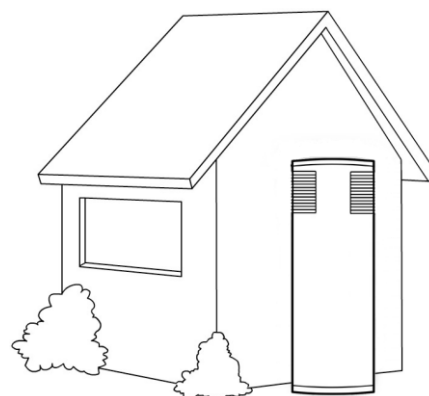

The water heater must not be installed in an area with a corrosive atmosphere where chemicals are stored or where aerosol propellants are released, as exposure to the corrosive atmosphere may attack the materials used in the water heater and heat pump system.

FREEZE PROTECTION

The water heater has a freeze protection function built in for extremely cold conditions. When a power supply is available to the water heater and the Display Panel is turned off at the water heater, the electric heating unit will automatically turn on if the water temperature in the water heater falls to 5°C. It will heat the water until the water temperature reaches 10°C and then turn off.

The water heater has NO WARRANTY for freeze damage if power is unavailable at the water heater.

⚠ Warning: In areas where the ambient air temperature may fall below 4°C, power must be available to the water heater at all times.

MAINS WATER SUPPLY

Where the mains water supply pressure exceeds that shown in the table below, an approved pressure limiting valve is required and should be fitted as shown in the **cold water connection diagram** on page 37.

Model	251E280
Temperature pressure relief valve setting	1000 kPa
Expansion control valve setting *	850 kPa
Maximum mains supply pressure	
With expansion control valve	680 kPa
Without expansion control valve	800 kPa

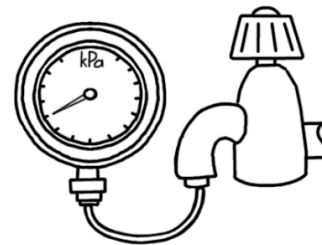

* Expansion control valve not supplied with the water heater.

TANK WATER SUPPLY

If the water heater is supplied with water from a tank supply and a pressure pump system is not installed, then the bottom of the supply tank must be at least 1 m above the highest point of the hot water plumbing system, including the water heater. Care must be taken to avoid air locks. The cold water line to the water heater should be adequately sized and fitted with a full flow gate valve or ball valve.

ANODE TYPES

The vitreous enamel lined cylinder of the water heater is only covered by the Everhot warranty when the total dissolved solids (TDS) content in the water is less than 2500 mg/L and when the correct colour coded anode is used. If an incorrect colour coded anode is used in the water heater, any resultant faults will not be covered by the Everhot warranty. In addition, the use of an incorrect colour coded anode may shorten the life of the water heater cylinder.

The correct colour coded anode for the water supply being used must be selected and fitted to the water heater for the Everhot warranty to apply to the water heater cylinder. Refer to **“Water Supplies”** on page 24 and the **Anode Selection table** on page 24. The black anode is typically fitted as standard.

If an incorrect anode is used, there is also the possibility the anode may become overactive and hydrogen gas could accumulate in the top of the water heater during long periods of no use. In areas where this is likely to occur, the installer should instruct the householder on how to dissipate the gas safely. Refer to **“Caution”** on page 25.

REDUCING HEAT LOSSES

The cold water line to and the hot water line from the water heater must be insulated in accordance with the requirements of AS/NZS 3500.4. The insulation must be weatherproof and UV resistant if exposed.

HOT WATER DELIVERY

⚠ Warning: This water heater can deliver hot water at temperatures up to 60°C, sufficiently hot to cause severe scalding. Water at this temperature may be plumbed to fixtures where water hotter than 50°C is allowed, such as the kitchen and laundry.

The installing plumber may have a legal obligation to ensure the installation of this water heater meets the water temperature delivery requirements of the Plumbing Code of Australia so that heated water delivered to fixtures and appliances used primarily for personal hygiene is at a temperature which is unlikely to scald.

It is necessary and we recommend that a temperature limiting device be fitted between the water heater and the fixtures and appliances used primarily for personal hygiene such as in a bathroom, ensuite, public amenities or other ablution areas, to reduce the risk of scalding.

The temperature limiting device used with a heat pump water heater should have a specified ‘minimum temperature differential’ between the hot water inlet and the tempered water outlet of no greater than 10°C. Refer to the manufacturer’s specifications of the temperature limiting device.

If a pressure limiting valve is installed on the cold water line to the water heater and the cold water line to a temperature limiting device branches off before this valve or from another cold water line in the premises, then a pressure limiting valve of an equal pressure setting may be required prior to the temperature limiting device.

Where a temperature limiting device is installed adjacent to the water heater, the cold water line to the temperature limiting device can be branched off the cold water line either before or after the isolation valve, pressure limiting valve and non-return valve to the water heater. If an expansion control valve is required, it must always be installed after the non-return valve and be the last valve prior to the water heater.

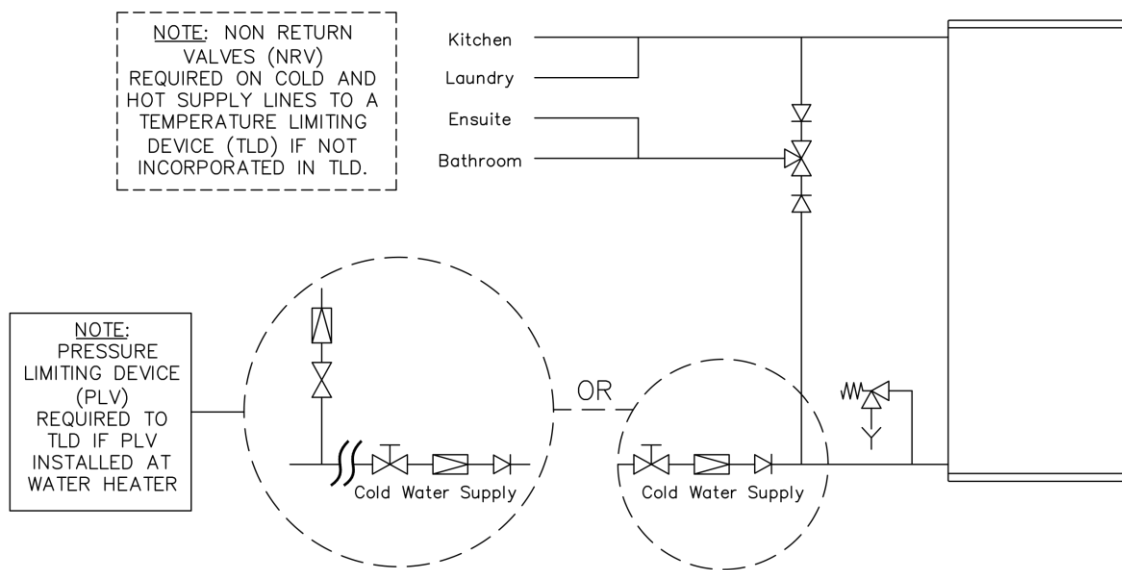

Two Temperature Zones Using a Temperature Limiting Device

CIRCULATED HOT WATER FLOW AND RETURN SYSTEM

This model heat pump water heater is not recommended to be installed as part of a circulated hot water flow and return system in a building.

SADDLING - PIPE WORK

To prevent damage to the cylinder when attaching pipe clips or saddles to the water heater jacket, we recommend the use of self-drilling screws with a maximum length of 13 mm. Should pre-drilling be required, extreme caution must be observed when penetrating the jacket of the water heater.

Note: If the cylinder is damaged as a result of attaching pipe clips or saddles to the jacket, any resultant faults will not be covered by the Everhot warranty.

DIMENSIONS AND TECHNICAL DATA

Dimensions

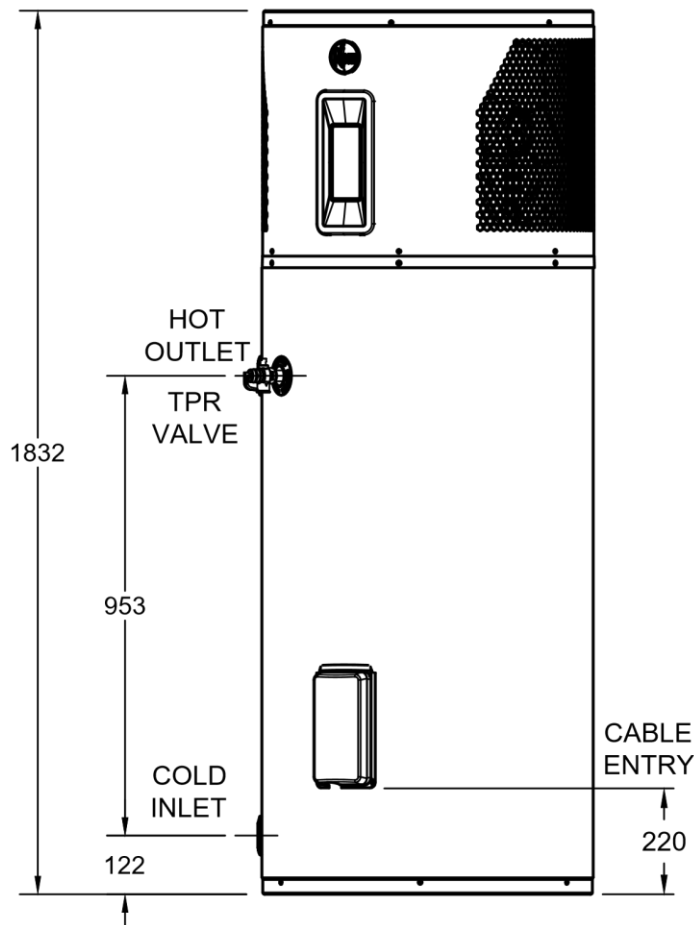
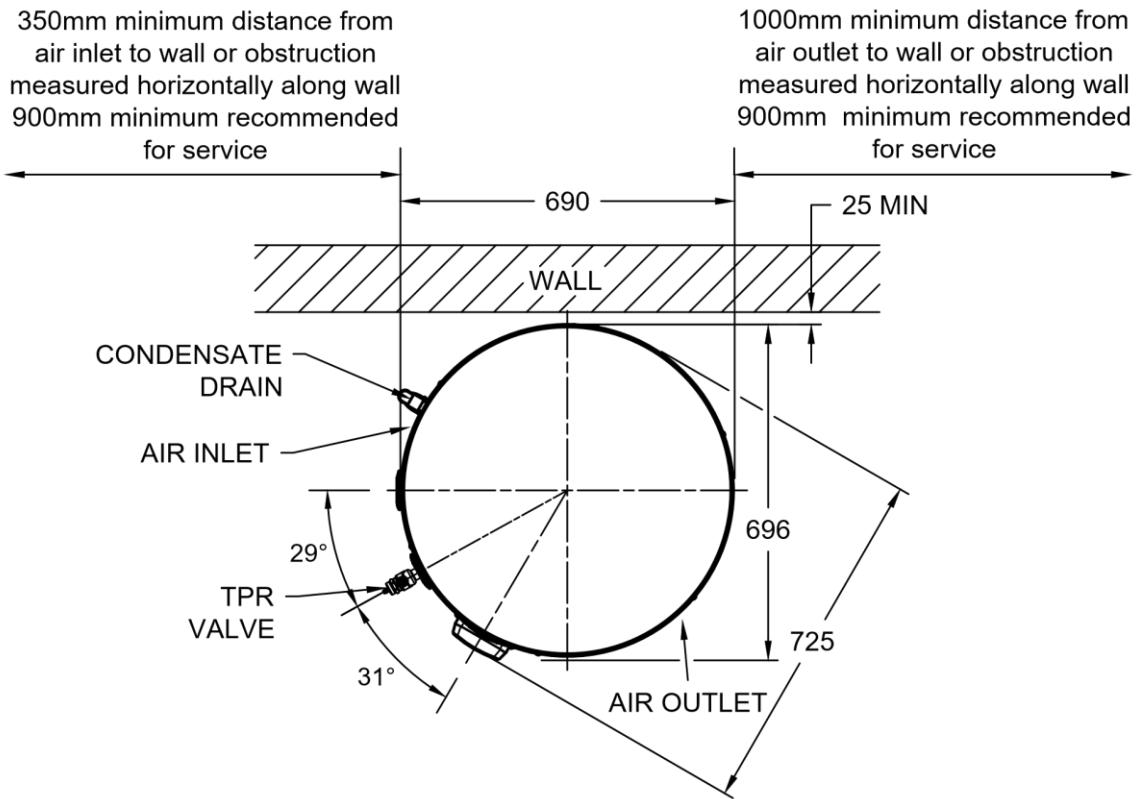

Model 251E280

There is a minimum clearance of 25 mm from a wall behind the water heater

Technical Data

Model number		251E280		
Product number – with black anode (magnesium)		251E280R5	Refrigerant type	R290
Product number – with blue anode (aluminium)		251E280R5/B	Maximum Refrigerant charge	340 grams
Storage capacity	litres	280	Refrigerant circuit pressure	2900 kPa
Boost capacity – by electric heating unit	litres	236	IP Rating	IP24
Weight system cartoned	kg	132	Average COP @ 19°C Ambient air temp & 10°C to 60°C water temp	4.9
Weight system full	kg	402	Avg HP Heating Capacity @ 19°C Ambient air temp & 10°C to 60°C water temp	2.9 kW
Rated heat pump power input @ 240 V	watts	690		
Electric heating unit rating @ 240 V	watts	2400		
Maximum rated power input @ 240 V	watts	3100		
Electrical circuit	Amps	15		

Technical data is subject to change

Heat Pump 251E280 Performance Specifications

Ambient Air Temperature	Relative Humidity	Average Heat Pump Heating Capacity (kW)	Recovery Rate @ 45°C rise (L / hr)	Average Coefficient of Performance (COP)
19°C	66%	2.9	56	4.9

Back-Up Heating Unit Recovery Rate @ 240 V

Heating Unit Rating	Recovery Rate @ 30°C rise (L / hr)	Recovery Rate @ 40°C rise (L / hr)	Recovery Rate @ 50°C rise (L / hr)
2400 watts	69	52	41

COP – The Coefficient of Performance (COP) for a heat pump is the ratio of how much useful heat it produces for water heating to the power input into the water heater. The higher the COP number, the more efficient the heat pump is. The actual COP of the product at any given time will be impacted by a number of factors, including the ambient air and cold-water inlet temperatures at the place of installation and time of day / season of operation.

The COP of 5.2 is the average value measured under test conditions with an ambient air temperature of 19°C/15°C (Dry Bulb/Wet Bulb) over the entire heat-up process, heating of the water from 10°C to 60°C during water heater operation and a power supply of 240 V~ 50 Hz. The Heat Pump average heating capacity in Watts and its water heating capacity in Litres / hour were calculated from the results of this test. The heat pump water heater performance tests were conducted to AS/NZS 5125.1:2014.

Ambient Air Temperature & Humidity – The performance of a Heat Pump changes with ambient air temperature, humidity and incoming water temperature. The warmer the air temperature and the higher the Relative Humidity and the cooler the water temperature, then the higher is the heating rate of the heat pump. Performance specifications stated in relation to the heat pump are measured at predefined conditions during its testing.

Average Heating Capacity kW – This is how much heating power is put into the water during the heating cycle. It is expressed as an average due to the changes in heating power from the refrigeration cycle as the water is being heated and its temperature increases during the heating cycle.

Recovery Rate @ 45°C rise L/hr – Is the number of litres of water that can be heated through a 45°C temperature rise in one hour, e.g. when the air temperature is 19°C, the heat pump can heat 56 litres of water from 15°C to 60°C in one hour.

TYPICAL INSTALLATION – OUTDOOR LOCATION

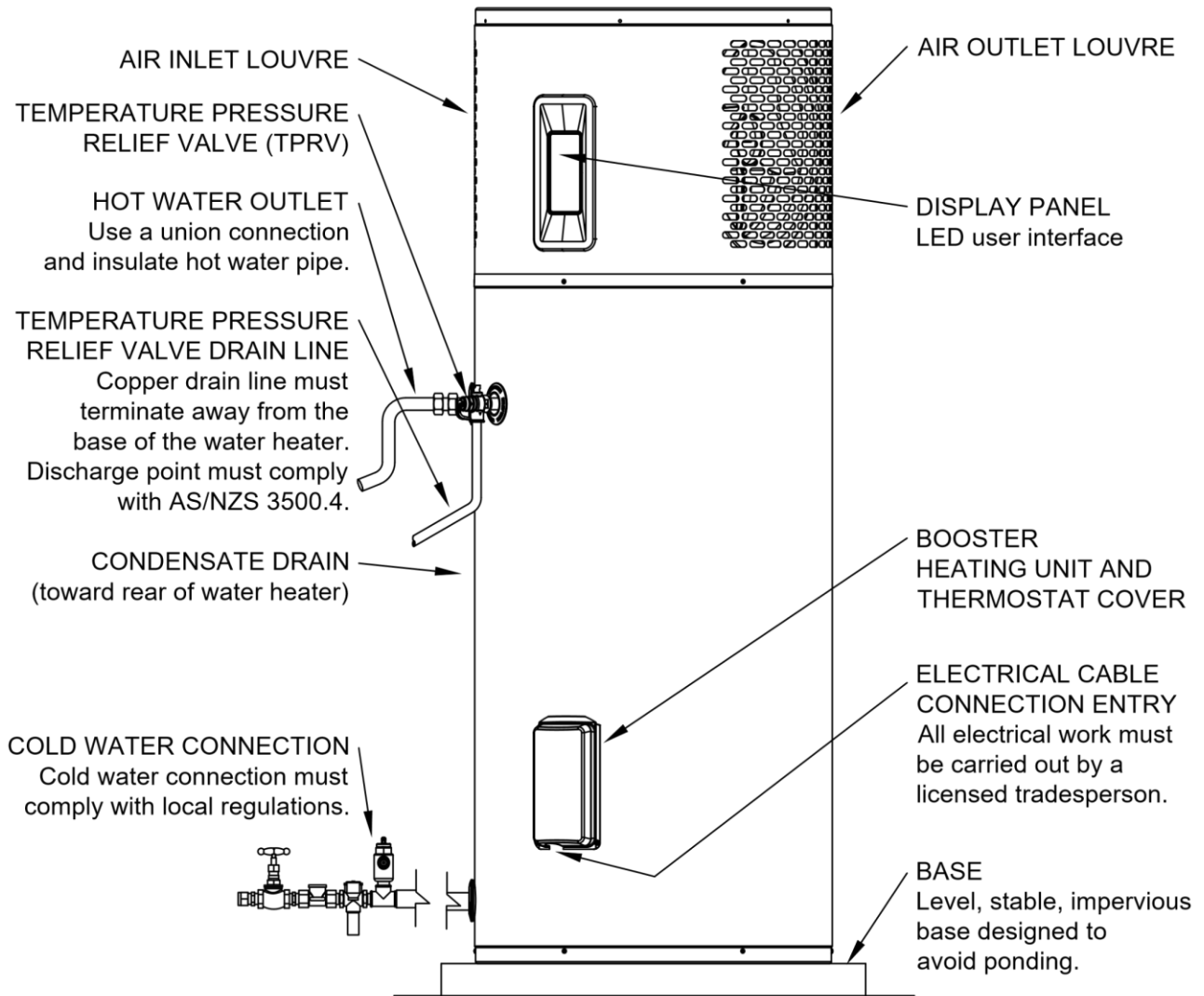

CONNECTIONS – PLUMBING

All plumbing work must be carried out by a qualified person and in accordance with the Standard AS/NZS 3500.4 and all local codes and regulatory authority requirements.

CONNECTION SIZES

- Hot water connection: Rp 3/4
- Cold water connection: Rp 3/4
- Relief valve connection: Rp 1/2

WATER INLET AND OUTLET

The pipe work must be cleared of foreign matter before connection and purged before attempting to operate the water heater. All olive compression fittings must use brass or copper olives. Use an approved thread sealant such as Teflon tape on all threaded joints.

An isolation valve and non-return valve must be installed on the cold water line to the water heater. An acceptable arrangement is shown in the diagram. Refer also to “Hot Water Delivery” on page 33 and to “Mains Water Supply” on page 32.

A disconnection union must always be provided at the cold water inlet and hot water outlet on the water heater to allow for disconnection of the water heater.

This water heater has either a plastic dip tube or fitting liner in the inlet and outlet fittings (see diagram). These must be in place for the water heater to function properly. Do not remove or damage them by using heat nearby. They will be pushed into the correct position as the fitting is screwed in.

This water heater is intended to be permanently connected to the water mains and not connected by a hose-set. A braided flexible hose or semi-flexible connector may be used for connection to the water heater, where permitted by AS/NZS 3500.4.

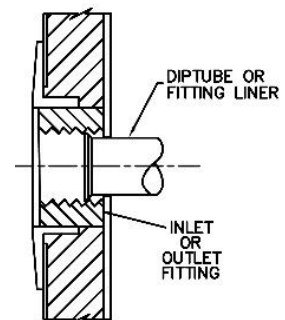
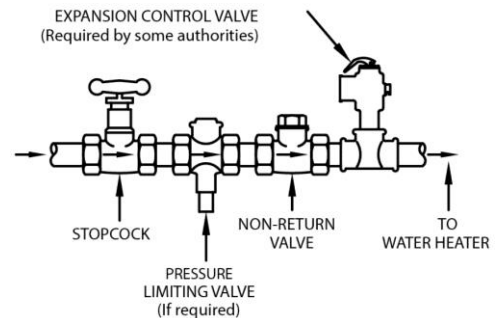

CONDENSATE DRAIN

A condensate drain hose is supplied with the water heater.

- Securely connect the condensate drain hose to the condensate drain spigot at the rear of the heat pump,
- Position the drain hose so it has a continuous fall all the way to the discharge outlet and there are no bends or distortions in it after it is installed,
- It may be necessary to use hose clips to secure the drain hose in position,
- Locate the discharge outlet of the drain hose such that flow out of the pipe can be easily seen and not cause damage or nuisance.

PIPE SIZES

To achieve true mains pressure operation, the cold water line to the water heater should be the same size or bigger than the hot water line from the water heater.

The pipe sizing for hot water supply systems should be carried out by persons competent to do so, choosing the most suitable pipe size for each individual application. Reference to the technical specifications of the water heater and local regulatory authority requirements must be made.

TEMPERATURE PRESSURE RELIEF VALVE

The temperature pressure relief valve is shipped with the water heater. The temperature pressure relief valve must be fitted before the water heater is operated. Before fitting the relief valve, make sure the probe has not been bent.

To fit the relief valve:

- Seal the thread with an approved thread sealant such as Teflon tape - never hemp. Make sure tape does not hang over the end of the thread.
- Hand tighten the valve into the opening marked "Relief Valve".

Refer to the [dimensions diagram](#) on page 34.

- Using a spanner engaged on the valve's spanner flats and applying medium pressure to tighten, turn the relief valve an additional ½ to 1 ½ turns to secure and make the joint watertight, leaving the valve drain pointing downwards.

⚠ Warning: Do not use a pipe wrench or poor fitting tool on the valve body nor over tighten the valve, as this could damage the valve and prevent safe operation.

- Operate the easing lever on the valve to check the smooth operation of the valve plunger. It is very important the lever is raised and lowered gently. The lever should move smoothly and without undue force.
- If the lever cannot be moved or is jerky in its movement, then the valve has been damaged and must be replaced.
- A copper drain line must be fitted to the temperature pressure relief valve.

Refer to "[Relief Valve Drain](#)" on page 39.

- The valve must be insulated with closed cell polymer insulation or similar (minimum thickness 9 mm) and the insulation installed so as not to impede the operation of the valve.

The insulation must be weatherproof and UV resistant if exposed.

EXPANSION CONTROL VALVE

In South Australia and Western Australia, it is mandatory to install an expansion control valve (ECV) in the cold water line to the water heater. In other areas, an ECV is required if the saturation index is greater than +0.4. Refer to "[Water Supplies](#)" on page 24.

The expansion control valve must always be installed after the non-return valve and be the last valve installed prior to the water heater. Refer to the [diagram](#) on page 37. A copper drain line must be fitted to the expansion control valve. Refer to "[Relief Valve Drain](#)" on page 39.

The valve, if installed within 500 mm of the water heater, must be insulated with closed cell polymer insulation or similar (minimum thickness 9 mm) and the insulation installed so as not to impede the operation of the valve. The insulation must be weatherproof and UV resistant if exposed.

RELIEF VALVE DRAIN

DN15 copper drain lines must be fitted to the temperature pressure relief valve and expansion control valve (if one is installed) to carry the discharge clear of the water heater. Connect the drain lines to the valves using disconnection unions. The drain line from the valve to the point of discharge should be as short as possible, have a continuous fall all the way from the water heater to the discharge outlet and have no tap, valves or other restrictions in the pipe work.

A drain line from a relief valve must comply with the requirements of AS/NZS 3500.4.

A drain line must have the number of changes in direction plus the length of the relief drain (in metres) not exceeding 12. The maximum length of 12 metres for a drain line is reduced by 1 metre for each bend or change of direction required. Where the distance to the point of final discharge exceeds this length, the drain line can discharge into a tundish. For example, a relief drain of 9 metres must have no more than three bends before discharging at an outlet or air-break.

The drain lines from the temperature pressure relief valve and expansion control valve from an individual water heater may be interconnected where freezing is unlikely. The combined drain line must have a minimum size of DN20 and discharge via a minimum air-break of 25 mm.

The outlet of a drain line must be in such a position that flow out of the pipe can be easily seen, but arranged so discharge will not cause injury, damage or nuisance. The termination point of a drain line must comply with the requirements of AS/NZS 3500.4. Drain lines must not discharge into a safe tray.

In locations where water pipes are prone to freezing, drain lines from the temperature and pressure relief valve and expansion control valve shall not be interconnected, must be insulated with a minimum thickness of 13 mm insulation, must not exceed 100 mm in length and are to discharge into a tundish through an air gap of 25 mm before the drain line enters a zone where freezing is likely.

If a drain line discharges into a tundish, the drain line from the tundish must be not less than DN20. The drain line from a tundish must meet the same requirements as for a drain line from a relief valve.

⚠ Warning: As the function of the temperature pressure relief valve on this water heater is to discharge high temperature water under certain conditions, it is strongly recommended the pipe work downstream of the relief valve be capable of carrying water exceeding 93°C. Failure to observe this precaution may result in damage to pipe work and property.

CONNECTIONS – ELECTRICAL

The power supply to the water heater must not be switched on until the water heater is filled with water and a satisfactory megger reading is obtained. There is NO WARRANTY for the dry firing of the electric heating unit.

Ensure the water heater has been in the installed position for a minimum of 30 minutes before switching on the electricity supply to the water heater. Refer to **“To Fill and Turn On The Water Heater”** on page 42.

MEGGER READING

When a megger test is conducted on this water heater, then the following should be noted.

⚠ Warning: This water heater contains electronic equipment and 500 V insulation tests must only be conducted between active and earth and between neutral and earth. An active to neutral test WILL damage the electronics.

An insulation test result of greater than 1 MΩ for this water heater is normal.

ELECTRICAL CONNECTION

All electrical work and permanent wiring must be carried out by a qualified person and in accordance with the edition of the Wiring Rules AS/NZS 3000 in force in the state or territory at the time of installation, and all local codes and regulatory authority requirements.

The water heater must be directly connected to a 220 V - 240 V a.c. 50 Hz mains power supply. The electrical power supply cable from the switch board to the water heater must be correctly sized to safely carry the maximum current draw of the heat pump and electric heating unit operating together on the water heater. The power supply must be able to supply a minimum of 13 Amps.

The water heater must be on its own circuit with an isolating switch installed at the switchboard. The Wiring Rules requires a second and lockable isolating switch be installed adjacent to but not on or attached to the water heater, and a residual current device (RCD) installed in the electrical circuit to the water heater.

A flexible 20 mm conduit is required for the electrical cable to the water heater. The conduit is to be connected to the unit with a 20 mm terminator at the front cover. Connect the power supply wires directly to the terminal block and earth tab connection, ensuring there are no excess wire loops inside the front cover. The temperature rating of the power supply wires insulation must suit this application, or the wiring protected by insulating sleeving with an appropriate temperature rating if it can make contact with the internal storage cylinder. The temperature of the internal storage cylinder can reach 60°C under normal operation.

The conduit and electrical cable are to be installed so they are not subject to wear, corrosion, excessive pressure, vibration, sharp edges or any other adverse environmental effects over the life of the water heater.

The 251E280 model water heater is recommended for connection to an uninterrupted 24 hour continuous tariff power supply. Depending upon the size of the household and its hot water requirements and if the Electricity Retailer permits, an extended off-peak (overnight and day) or Extended time-controlled power supply connection of a minimum 16 hours per day may also be suitable.

Note: It is not recommended to connect this water heater via a power switching device which allows alternative supply of grid power and photovoltaic (PV) power.

The water heater will only operate on a sine wave at 50 Hz. Devices generating a square wave cannot be used to supply power to the water heater.

ELECTRIC HEATING UNIT AND THERMOSTAT SETTING

The water heater has an electric heating unit and thermostat, and is controlled by the electronic controller. The electric heating unit will be automatically activated during periods when the ambient air temperature falls below -6°C or above 43°C and heating of the water is required. In addition, if the heat pump operates between -6°C and 7°C for longer than 3 hours 20 minutes, the electric heating unit will turn on to assist in the heating of the water. The thermostat and sensors controlling the heat pump and the electric heating unit are factory set and not adjustable.

TIMER

A Timer function on the Display Panel allows the hours of operation of the water heater to be set. Refer to “Clock and Timer” on page 18. It may be desirable for the heat pump not to operate between certain hours, such as during the peak period when connected to a Time of Use electricity supply due to a more expensive tariff rate applying.

Setting the Timer will affect the operating times of both the heat pump circuit and the electric heating unit.

Note: If there is a risk of freezing conditions, the electrical supply to the water heater should not be switched off, otherwise damage could result. Refer to “Freeze Protection” on page 10.

WIRING DIAGRAM

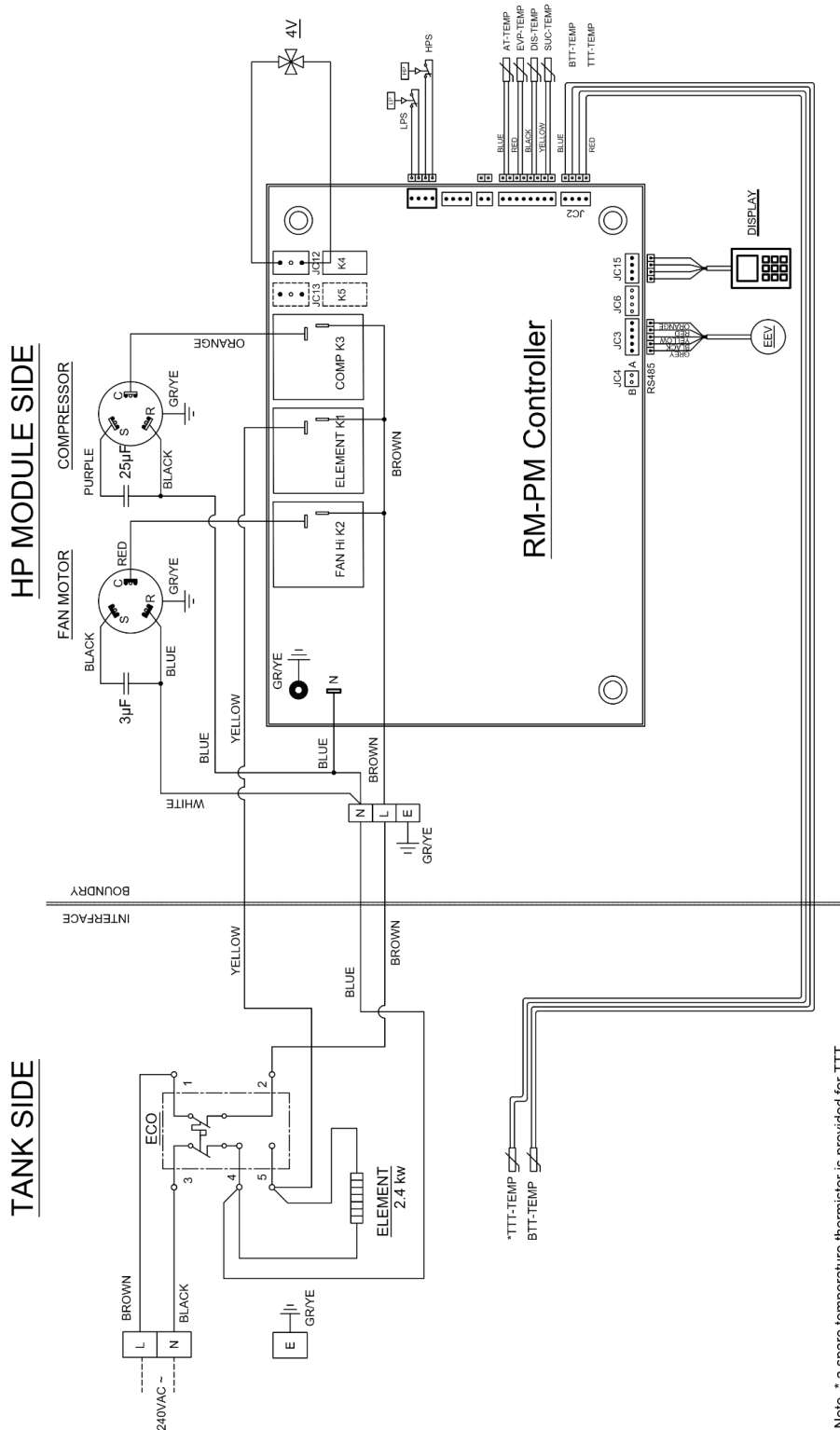

COMMISSIONING

TO FILL AND TURN ON THE WATER HEATER

The power supply to the water heater must not be switched on until the water heater is filled with water and a satisfactory megger reading is obtained.

- Open all of the hot water taps in the house (don't forget the shower).
- Open the cold water isolation valve fully to the water heater.

Air will be forced out of the taps and the air bleed valve.

- Close each tap as water flows freely from it.
- Check the pipe work for leaks.
- Inspect for leaks at the temperature pressure relief valve connection to the water heater.

If a leak is detected, close the cold water isolation valve fully and relieve pressure from the water heater by either operating the easing lever on the temperature pressure relief valve or opening a hot tap. Remove the valve and all of its thread sealant from the threads of the valve. Reapply new thread sealant and refit the valve.

Refer to the procedure in "[Temperature Pressure Relief Valve](#)" on page 38.

- Operate the easing lever on the temperature pressure relief valve to check the smooth operation of the valve plunger and that water discharges freely from the drain line. It is very important the lever is raised and lowered gently. The lever should move smoothly and without undue force.

If the lever cannot be moved or is jerky in its movement, then the valve has been damaged and must be replaced.

- Ensure the water heater has been in the installed position for a minimum of 30 minutes before switching on the electricity supply to the water heater.
- Switch on the electrical supply at the water heater isolating switch on the switchboard and at the isolating switch at the water heater.

Note: When the electrical supply is switched on, there will be a knocking sound from the heat pump for a short period of time. This is the electronic expansion valve operating. This is normal and not a fault with the heat pump.

- Turn the water heater "On" at the Display Panel.

Refer to "[Turn the Water Heater "On" at the Display Panel](#)" on page 17.

- Set the Clock on the Water Heater, and if required, set the Timer period.

Refer to "[Clock and Timer](#)" on page 18.

The heat pump may take up to 5 minutes to commence operating when the power supply is switched on. The heat pump will only operate when the water in the storage tank requires heating and power is available at the water heater.

If the ambient air temperature is below -6°C or above 43°C and the system calls for heating, the heat pump will not operate and the electric heating unit will operate instead.

When the heat pump is operating, the system may switch to the electric heating unit if it detects that the ambient air temperature is below the minimum operating temperature of -6°C or above the maximum operating temperature of 43°C. It may also switch back to heat pump operation from the electric heating unit if it detects the ambient air temperature has moved back to within the heat pump's operating temperature range.

Note: The heat pump may not turn on after having just completed a heating cycle and more hot water is drawn from the water heater, or whilst the heat pump was operating and either power was switched off or it was turned "Off" at the Display Panel. The heat pump may wait a few minutes before operating and the conditions for start-up are favourable.

It is important to wait for five minutes after the heat pump has activated to ensure it continues to operate and is functioning correctly.

Explain to the householder or a responsible officer the functions and operation of the heat pump water heater. Upon completion of the installation and commissioning of the water heating system, leave this guide with the householder or a responsible officer.

TO TURN OFF THE WATER HEATER

If it is necessary to turn off the water heater on completion of the installation, such as on a building site or where the premises are vacant, then:

- Turn the water heater off at the Display Panel.
- Switch off the electrical supply at the water heater isolating switch on the switchboard and at the isolating switch at the water heater.
- Close the cold water isolation valve at the inlet to the water heater.

Notes

- The freeze protection system will be rendered inoperable if electrical power is not available at the water heater.
- Damage caused by freezing due to the unavailability of power at the water heater is not covered by the Everhot warranty.

Refer to “[Terms of the Everhot Warranty](#)” on page 4.

- If the power has been switched off to the water heater and there is a risk of freezing, then it is necessary to drain the water heater.

Refer to “[Draining The Water Heater](#)” on page 43.

DRAINING THE WATER HEATER

 **Warning:** Exercise care, as water discharged from the water heater may be of a very high temperature.

To drain the water heater:

- Turn off the water heater.
Refer to “[To Turn Off The Water Heater](#)” on page 43.
- Close all hot water taps.
- Operate the relief valve lever - do not let the lever snap back or you will damage the valve seat. **It is very important the lever is raised and lowered gently.**

Operating the lever will release the pressure in the water heater.

- Undo the union at the cold water inlet to the water heater and attach a hose to the water heater side of the union.

Let the other end of the hose go to a drain.

- Open the relief valve by holding the lever in the raised position.

This will let air into the water heater and allow the water to drain through the hose.

MAINTENANCE, REPAIR, DECOMMISSIONING, DISPOSAL



WARNINGS

Be aware that the refrigerant used in this heat pump is flammable.

The refrigerant is R290 (Propane).

It may not contain an odour if it were to leak.

Only a person qualified in working with flammable refrigerants can access the refrigerant circuit (sealed system) to: maintain, repair or service the heat pump, or; to decommission the heat pump and dispose of the refrigerant.

The information in this section does not replace the Service Instructions for the Everhot 251E280 heat pump. The Service Instructions should be referred to for the full and complete procedures for maintenance, repair, decommissioning and disposal of the heat pump. This section is for information only.

WARNINGS – MAINTENANCE AND REPAIR WORK

If maintenance or repair of the sealed system containing the flammable refrigerant is required, then this service work shall be undertaken by a person qualified in handling flammable refrigerants.

The following should be noted if this type of servicing is required:

- The servicing shall occur in an open well ventilated area and remain well ventilated for the duration of the service work.

Ensure the area is well ventilated before opening the sealed system or conducting any hot work. Any accidentally released refrigerant should be able to disperse safely.

- Be aware when a refrigerant leak is possible that malfunction of the heat pump may be caused by refrigerant loss.
- During repair work, when brazing is required, the following procedures shall be carried out:
 - Evacuate the refrigerant circuit (sealed system) and remove the refrigerant.
 - Purge the refrigerant circuit (sealed system) with nitrogen for five (5) minutes.
 - Evacuate the refrigerant circuit (sealed system) again.
 - Remove parts to be replaced by cutting, not by flame.
 - Purge the braze point with nitrogen during the brazing procedure,
 - Carry out a leak test before charging with refrigerant.
- Reassemble sealed enclosures accurately. If seals are worn replace them.
- Check safety equipment before recommissioning the heat pump into service.

GENERAL PRINCIPLES

Detection of Refrigerant

When searching for or detecting a refrigerant leak, potential sources of ignition shall not be used under any circumstances.

An electronic leak detector may be used to detect refrigerant leaks if it has the sensitivity to do so and is suitable for the detection of R290 refrigerant. The detector must not be a potential source of ignition. Leak detection equipment shall be set at a percentage of the LFL of and be calibrated for R290 refrigerant.

Leak detection fluids are also suitable but the use of detergents containing chlorine shall be avoided as the chlorine may react with the R290 and also corrode copper pipework.

If a leak is detected, all naked flames shall be removed / extinguished. If a leakage of refrigerant is found which requires brazing, all refrigerant shall be recovered from the heat pump prior to repair work being conducted.

Evacuation and Removal of the Refrigerant

Conventional procedures shall be used if the refrigerant circuit (sealed system) is to be opened. Refrigerant R290 is flammable, therefore the following procedure shall be followed:

- Evacuate the refrigerant circuit (sealed system) and remove the refrigerant.
- Purge the refrigerant circuit (sealed system) with nitrogen for five (5) minutes.
- Evacuate the refrigerant circuit (sealed system) again.
- Remove parts to be replaced by cutting, not by flame.

The refrigerant shall be recovered into the correct recovery cylinders. The sealed system shall be purged with nitrogen to render the heat pump safe. This process may need to be repeated several times. Compressed air or oxygen shall not be used for purging the refrigerant lines.

Purging shall be achieved by breaking the vacuum in the system with nitrogen and continuing to fill until the working pressure is achieved, then venting to atmosphere, and finally pulling down to a vacuum. This process shall be repeated until no refrigerant is within the system. When the final nitrogen charge is used, the system shall be vented down to atmospheric pressure to enable service work to take place. This process is vital if brazing operations on the pipe work are to take place.

The outlet of the vacuum pump must not be close to any potential ignition sources, and the point of discharge is well ventilated.

Good practise is to be followed when removing refrigerant from the sealed system during servicing or decommissioning to ensure all refrigerant is removed safely.

- Only appropriate refrigerant recovery cylinders shall be used and labelled for R290 refrigerant.
- A recovery cylinder shall be complete with pressure relief valve and associated shut-off valves in good working order, evacuated and if possible, cooled before recovery occurs.
- The recovery equipment shall be in good working order and suitable for the recovery of R290 refrigerant.
- Hoses shall be complete with leak-free disconnect couplings and in good condition.
- The recovery machine is to be checked to ensure it is in satisfactory working order, has been properly maintained and that any associated electrical components are sealed to prevent ignition in the event of a refrigerant release.
- Calibrated weighing scales shall be available and in good working order.

Recovered refrigerant shall be disposed of correctly and a waste transfer note arranged. Do not mix refrigerants in recovery cylinders.

Charging Procedure

Prior to recharging the sealed system, pressure test the system with nitrogen.

In addition to conventional charging procedures, the following should be noted:

- Ensure the contamination of different refrigerants does not occur when using charging equipment. Hoses and lines should be as short as possible to minimise the amount of refrigerant in them.
- Charging cylinders shall be kept in an appropriate position according to their instructions.
- Ensure the refrigerating system is earthed prior to charging the system with refrigerant.
- If not already labelled, label the system when charging is complete.
- Exercise extreme care so as not to overfill the refrigerating system.

Leak test the sealed system upon completion of the charging but prior to commissioning, and again after commissioning prior to leaving the site.

Recovery of Compressor Oil

Good practise is to be followed when removing compressor oil during servicing or decommissioning to ensure all oil is removed safely.

If the compressor or compressor oil are to be removed, ensure they have been evacuated of refrigerant to an acceptable level to make certain no refrigerant remains within the lubricant. Only electric heating to the compressor body shall be employed to accelerate the evacuation process. When oil is drained from a sealed system, it shall be carried out safely. The evacuation procedure shall be carried out before disposing of the compressor.



WARNINGS – DECOMMISSIONING AND DISPOSAL

At the end of the water heater's life, the decommissioning and disposal of the heat pump shall be undertaken by a person qualified in handling flammable refrigerants.

The following should be noted:

- If the safety is affected when the heat pump is put out of service, the refrigerant charge shall be removed before decommissioning.
- The decommissioning shall occur in an open well ventilated area and remain well ventilated for the duration of the decommissioning work.

Ensure the area is well ventilated before opening the sealed system or conducting any hot work. Any accidentally released refrigerant should be able to disperse safely.

- Be aware when a refrigerant leak is possible that malfunction of the heat pump may be caused by refrigerant loss.
- During decommissioning, the refrigerant is to be recovered and disposed of in accordance with governing regulations.
 - Evacuate the refrigerant circuit (sealed system) and remove the refrigerant.
 - Purge the refrigerant circuit (sealed system) with nitrogen for five (5) minutes.
 - Evacuate the refrigerant circuit (sealed system) again.
 - Fill with nitrogen up to atmospheric pressure.
 - Place a label on the heat pump that the refrigerant is removed.
- Cut out the compressor and drain the oil.
- Do not pierce or burn any components of the heat pump.

This page is intentionally blank.

This page is intentionally blank.



INSTALLATION REPORT

Dear Installer / Customer

A copy of this installation report for the heat pump is to be attached to an STC Assignment Form (where applicable) as proof of installation. It can be copied and kept for your records. An electronic version may be provided by the installer instead.

Installer, please complete all details below

Owner's Name							
Installation Address							
Suburb		Telephone Home					
State		Work					
Postcode		Mobile					
Email Address							
Installing Company / Agent		No. of Stories of Install		Single	Other		
Installer's Name		Installation Date					
Type of Installation (please circle)	Replace Complete Solar System	Replace Solar Tank	Replace Electric or Gas	Replace Heat Pump	New Building	New Install on Existing Building (not replacing a unit)	Other
System Model No		System Type					
Tank Model No		Tank Serial No					
Electric Booster (please circle)	Electric continuous	Off Peak 1 (night)	Off Peak 2 (night & day)	Other			

If replacing a water heater, please give details

Brand		Model No		Electric	Gas
If an Everhot, Rheem or Vulcan unit	Tank Serial No		Date of manufacture		
Comments					
Signature:	Installer:		Customer:		
Date					

This page is intentionally blank.

This page is intentionally blank.

