

# Installation and Operating Instructions

## FRK204104-Waste Bin 13.5L,WM

2030048724

365 x 720 x 117

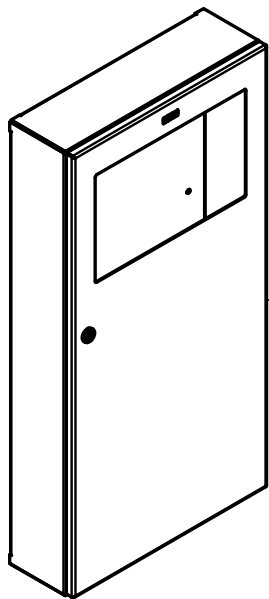
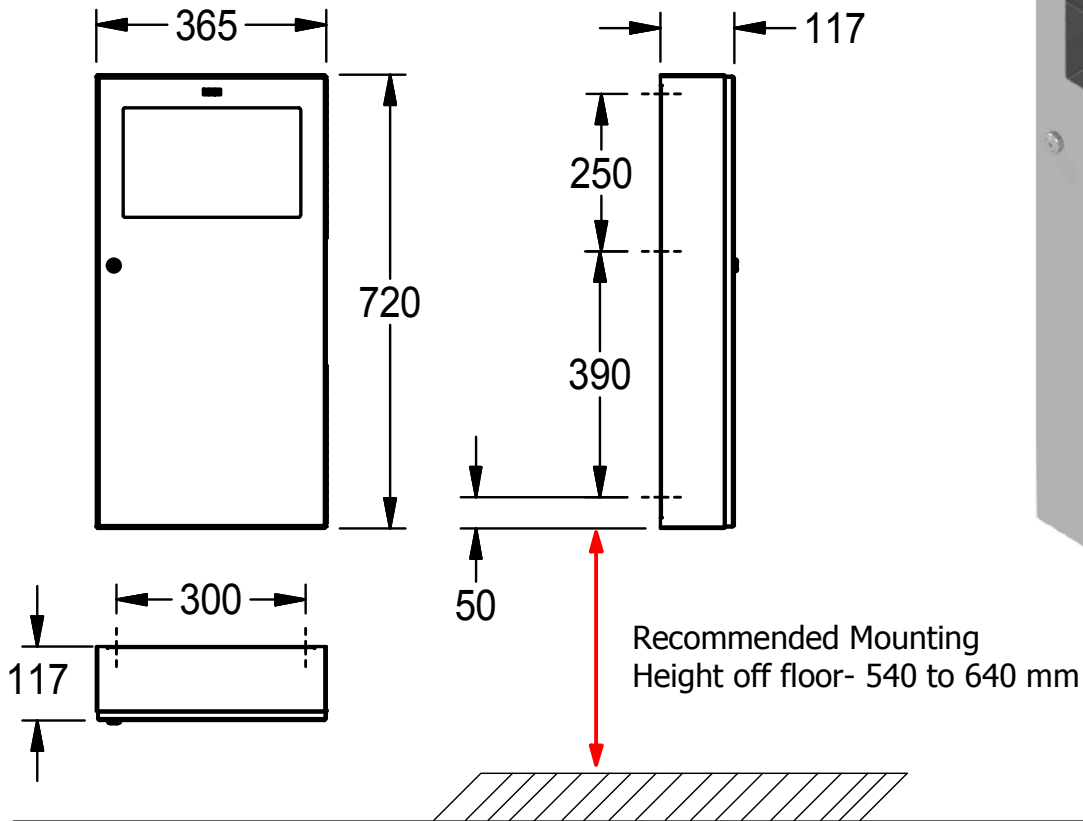

1x

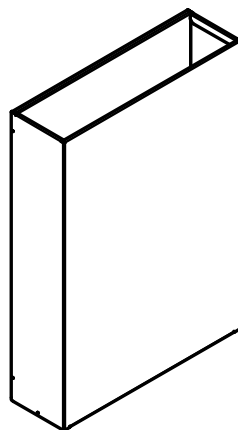

1x

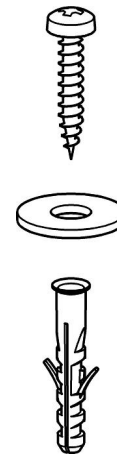

6x

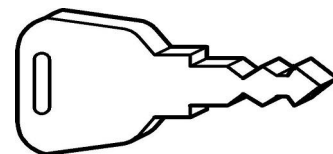

1x

## MATERIALS:

1. SS304 Grade Stainless steel; all the surfaces have satin-finish.

## INSTALLATION GUIDELINES:

1. Use the keys provided to open the door of the unit.
2. Remove the waste bin from the unit.
3. Place the Unit on the wall and mark the exact point and the mounting hole distance.
4. Drill mounting holes on the wall using the reference marked dots.
5. Fix the plastic dowel in to the hole and make sure they are flushed with the wall.
6. Now place the unit on the wall and install the screws into the mounting holes.
7. After finishing if the unit is loose, make sure the screws are all the way in and the screw heads are the only visible parts.
8. Finally place the waste bin in to the unit and close the door.

## REPLACEMENT PARTS:

1. Lock and key set- 2000103362

## NOTE:

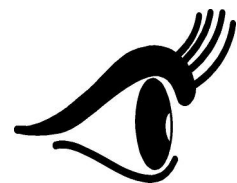
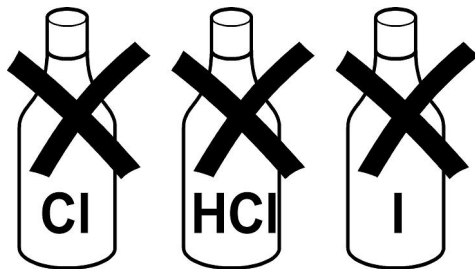

[www.franke.com/ae/en/ws](http://www.franke.com/ae/en/ws)

Franke L.L.C  
P.O. Box 14511  
Ras Al Khaimah / United Arab Emirates  
t: +971 (0)7 2034 700  
e: ws-info.ae@franke.com

**FRANKE**