

AUTO PRESSURE CONTROL SPEC SHEET

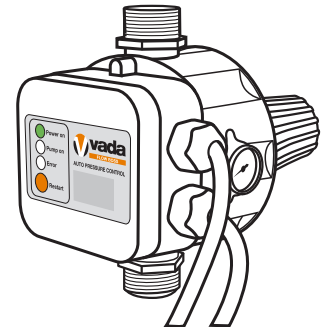

COMPATIBLE VADA PRODUCTS:

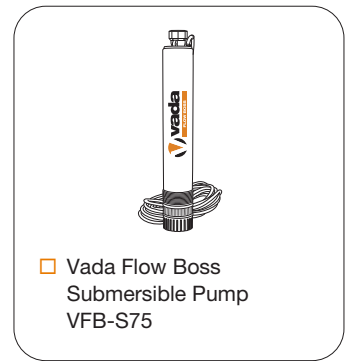
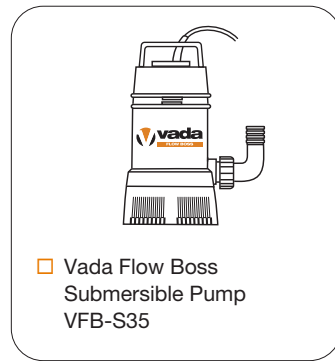
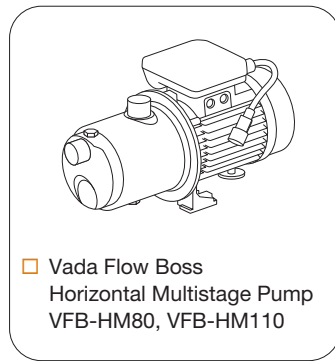
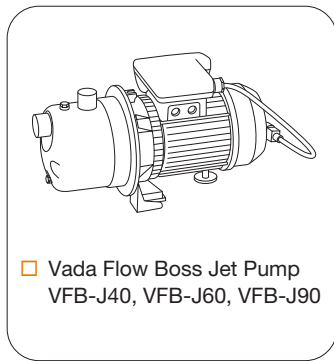

PRODUCT DIMENSIONS:

- A. 174mm
- B. 188mm
- C. 147mm

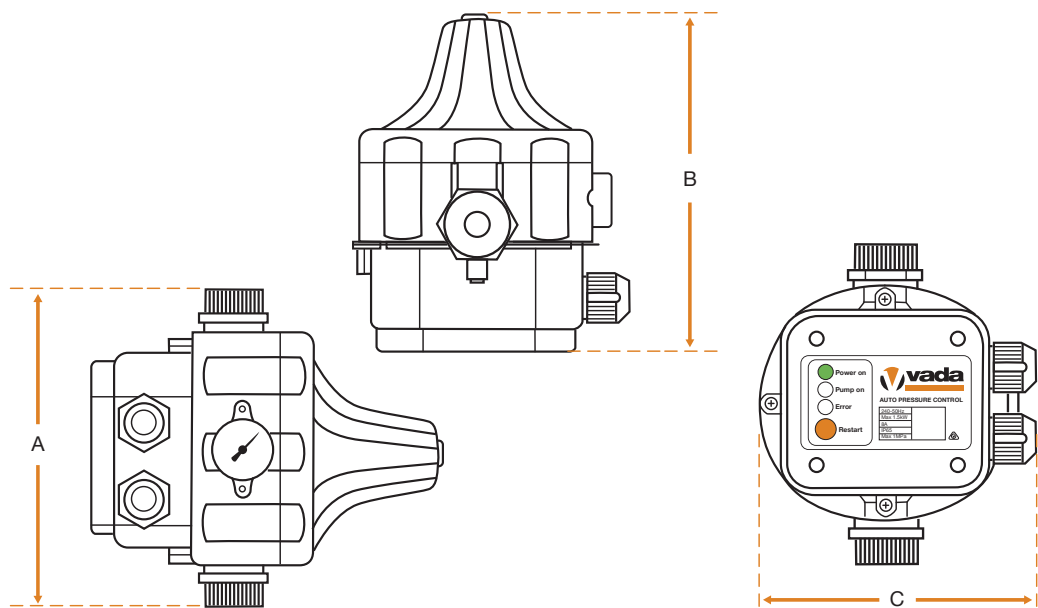



CONTROLS AND DISPLAY:

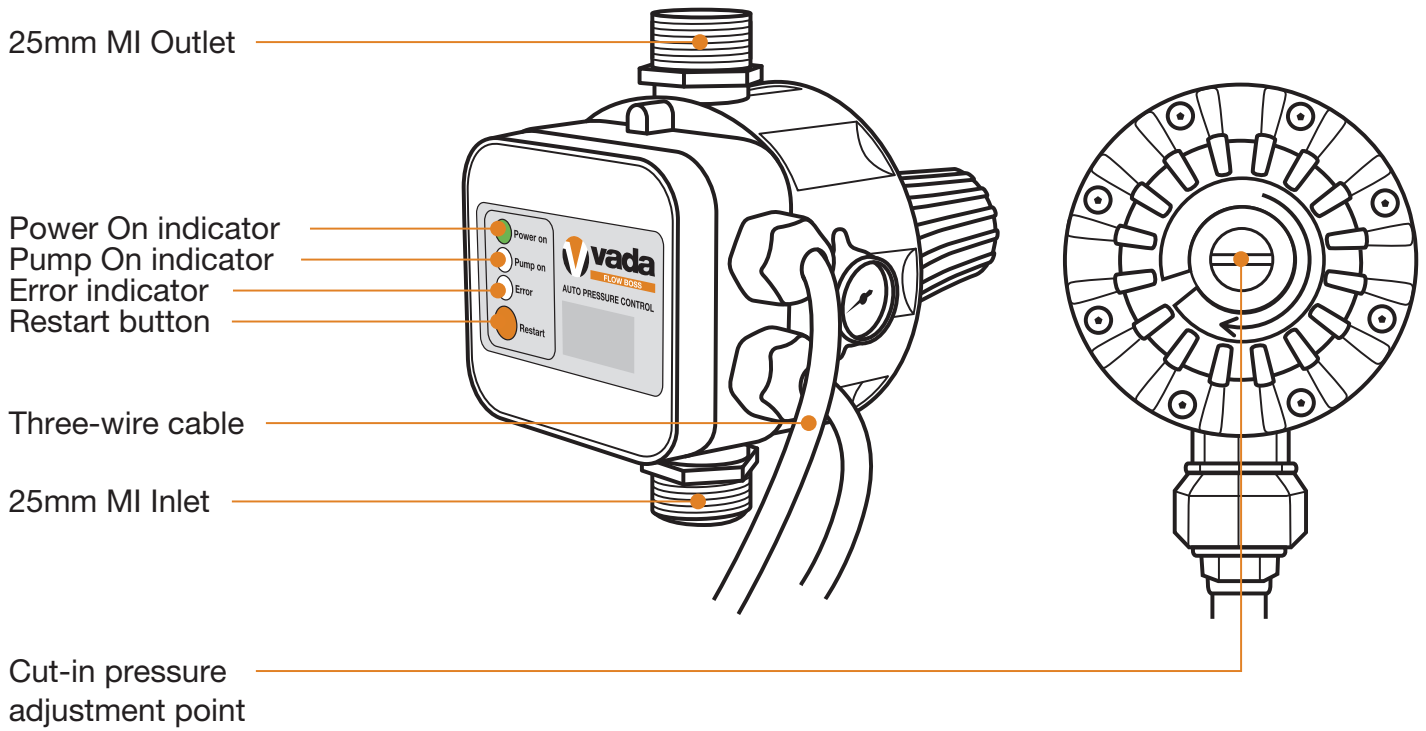

SPECIFICATIONS	
Inlet	25mm MI
Outlet	25mm MI
Max operating pressure	1000kPa/10 bar
Min pump pressure	250kPa/2.5 bar
Min-max water temperature	1°C-65°C
Min-max ambient temperature	1°C-40°C
Supply voltage	1~240V 50Hz
Cut-in pressure	150-300kPa/1.5-3 bar
Max power	1.5kW
Max current	10A
IP rating	IP65

AS/NZS 4020 compliance.