

Villa 380 Semi-Inset Basin Solid Surface

SPECIFICATIONS

Recommended Use	Domestic, Hotel & Commercial
Material	Solid Surface
Colour	White Haven or Cove Grey
Capacity	7.5 litres
Weight	4.6 kg
Overflow	No
Plug & Waste	32-40mm Pop-up Waste with Matching Solid Surface Waste Cap
Taphole	No Taphole
Fixing	Silicone to Benchtop

WARRANTY

Domestic Use	15 Years
Spare Parts & Labour	12 Months

Please refer to Warranty Page for full Terms and Conditions

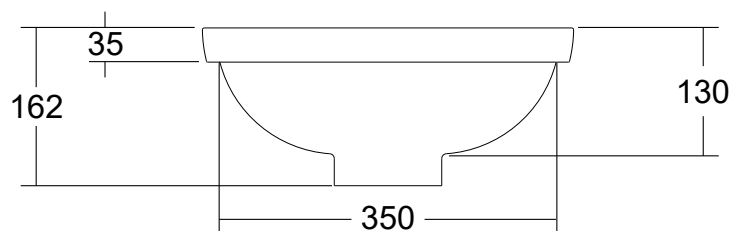
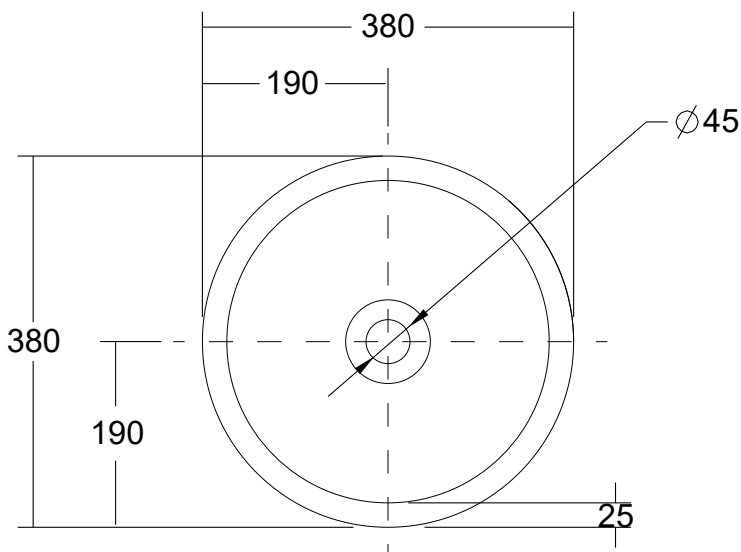

Dimensions are nominal measurements only.

Disclaimer: Products in this specification manual must by regulation be installed by licensed and registered trade people. The manufacturer/distributor reserves the right to vary specifications or delete models from their range without prior notification. Dimensions are nominal measurements only. Dimensions and set-outs listed are correct at time of publication however the manufacturer/distributor takes no responsibility for printing errors.

Published 21/12/2021