



Milli Oria Cross Wall Top Assembly

SPECIFICATIONS

Recommended Use	Domestic, Commercial, Hotel
Colour	Chrome, Matte Black, Brushed Nickel, Brushed Gunmetal, Brass Gold
Recommended Pressure Range	300 - 500Kpa
Max Continuous Working Pressure	500Kpa
Max Continuous Working Temperature	65 deg. C
Suitable for Storage Tank Hot Water	Yes
Suitable for Continuous Flow Hot Water	No
Suitable for Gravity Feed Hot Water	No

WARRANTY

Warranty - Domestic Use	15 Years
Spare Parts	5 Years
Labour	1 Year

Please refer to Warranty Page for full Terms and Conditions

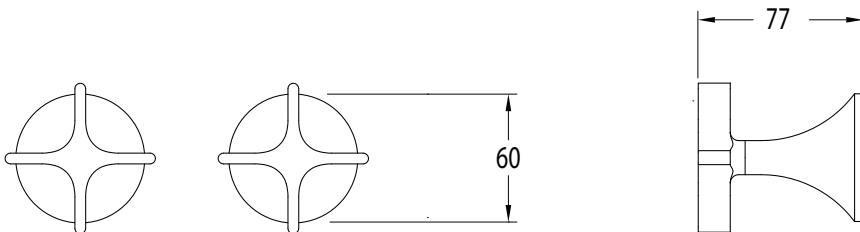
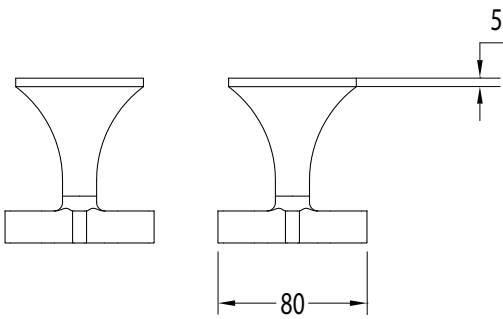
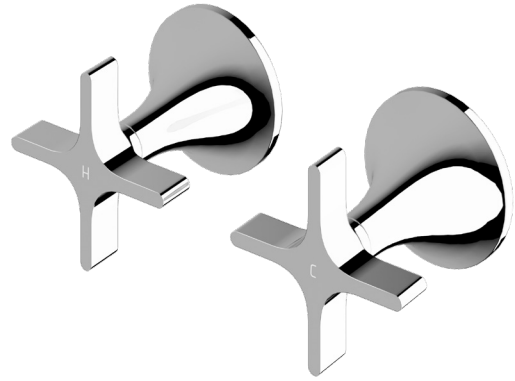

Dimensions are nominal measurements only.

Disclaimer: Products in this specification manual must by regulation be installed by licensed and registered trade people. The manufacturer/distributor reserves the right to vary specifications or delete models from their range without prior notification. Dimensions are nominal measurements only. Dimensions and set-outs listed are correct at time of publication however the manufacturer/distributor takes no responsibility for printing errors.

Published 13/10/2023

To see the complete Milli range go to www.reece.com.au/bathrooms



AS/NZS 3718
LIC. 20081



Milli

Milli Oria Cross Wall Top Assembly

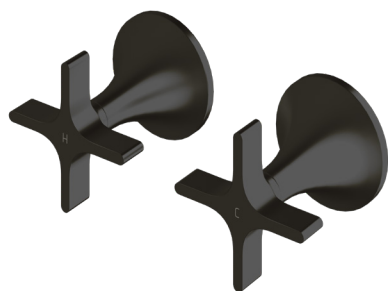

PVD MATTE BLACK

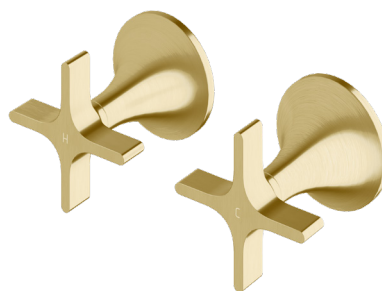

PVD BRUSHED GOLD

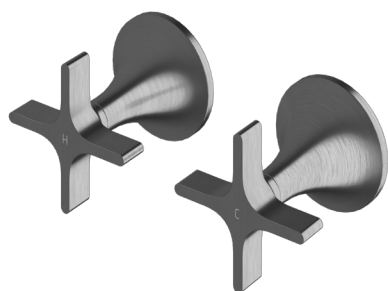

PVD BRUSHED GUNMETAL

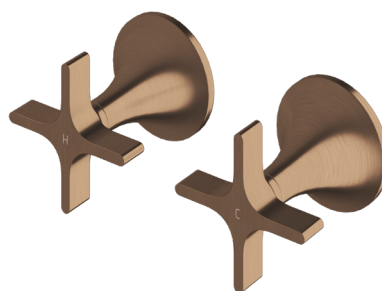

PVD BRUSHED RARE BRONZE

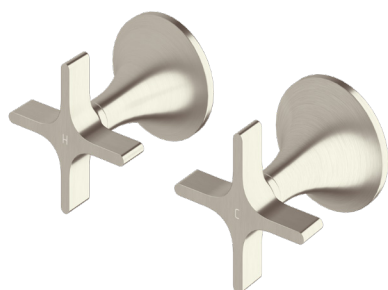

PVD BRUSHED NICKEL

Disclaimer: Products in this specification manual must by regulation be installed by licensed and registered trade people. The manufacturer/distributor reserves the right to vary specifications or delete models from their range without prior notification. Dimensions are nominal measurements only. Dimensions and set-outs listed are correct at time of publication however the manufacturer/distributor takes no responsibility for printing errors.

Published 13/10/2023

To see the complete Milli range go to www.reece.com.au/bathrooms

