

Mizu Silk Extended Basin Mixer 5 Star

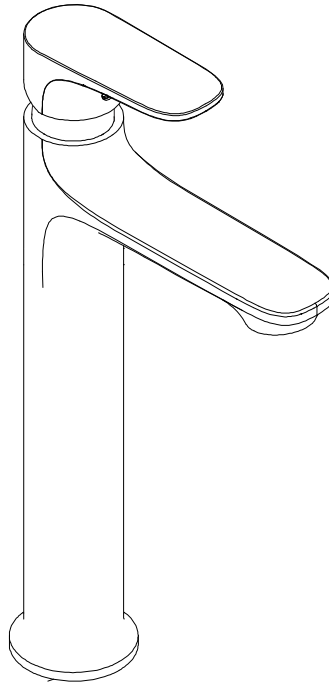

Components Supplied

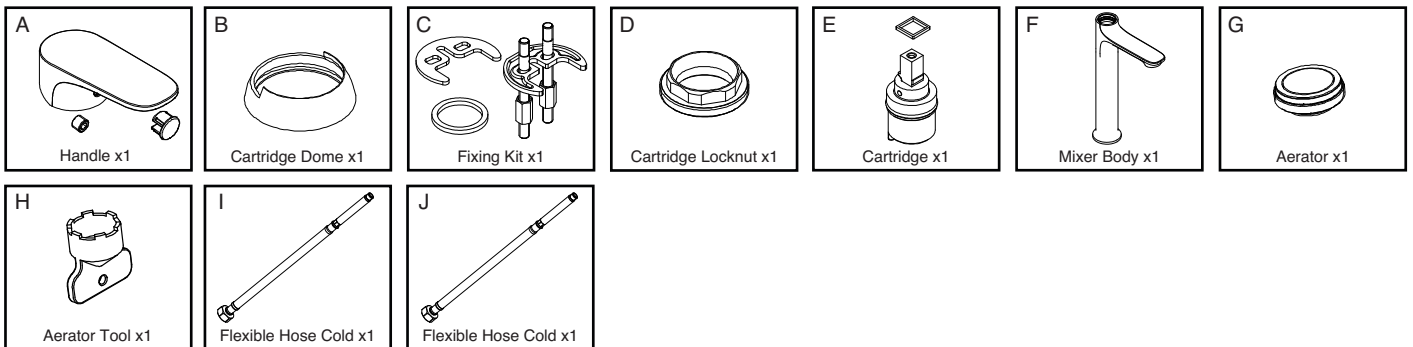

Tools Required

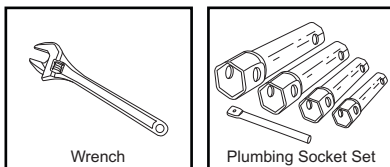

Installation Instructions

Important Mixer must be installed to the requirements of AS/NZS 3500 by a qualified plumber. Your mixer comes to you already factory assembled and tested. We do not recommend the dismantling of any internal part of the mixer. The mixers are factory tested and sealed so as to give the best performance.

mizu

Installation



Flush out new pipe work prior to connecting the new mixer.



All mixers should be installed with isolating stop cocks (Arco).

Note: This tap is suitable for high pressure applications where both hot and cold water supply pressures are at 150kpa or above.

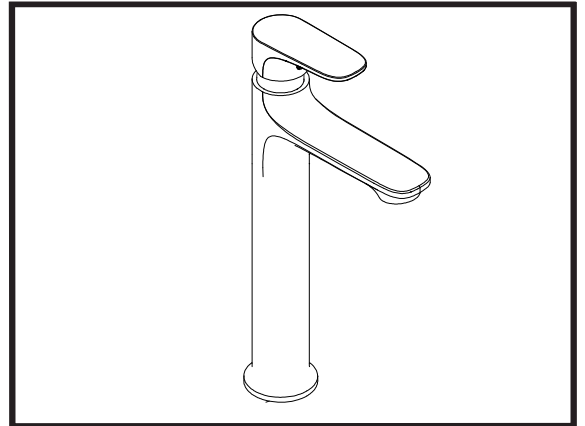

- Fit fixing kit shanks (1) to bottom of the mixer body (2) and position sealing washer (3) around the tap hole.
- Place the tap body (2) into the mounting hole, making sure that the flexible hoses are firmly tightened into the base of the body (2).

Note: DO NOT use teflon tape on threads.

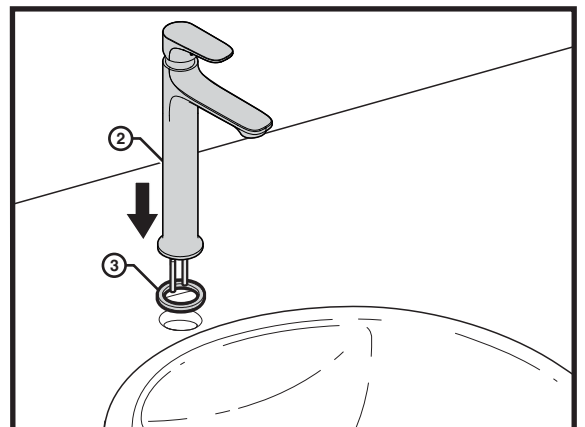
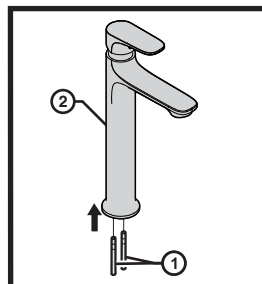

- Connect both the hot and cold flexible hoses (1) hand tight and then half a turn further using a wrench.
- From underneath, apply horseshoe washer (2) prior to positioning the horseshoe plate (3).
- Lock the mixer to the basin or benchtop by tightening the locking nuts (4).
- Connect both the hot and cold flexible hoses (1) to their respective water supplies.
- Ensure that the hoses (1) are not under tension, twisted or kinked.

Note: Hoses must have minimum bend radius of 30mm.



Check for water leaks after installation.

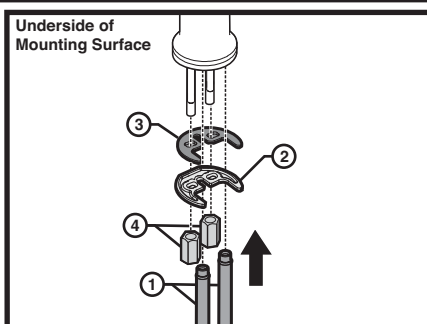
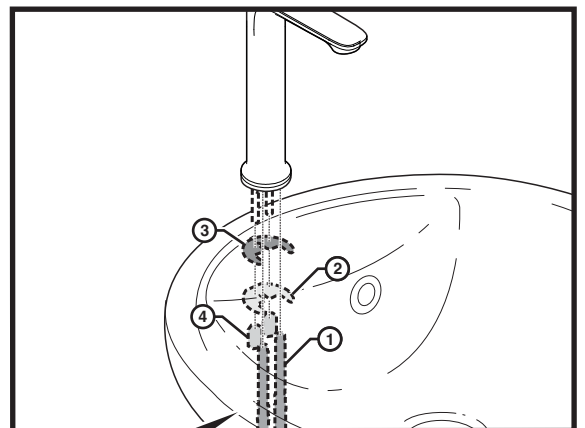

mizu

Servicing - Replacement of Cartridge

- Remove decorative cover (1) and unscrew the grub screw (2) using an allen key.
- Lift off the handle (3) and remove the cartridge dome (4), unscrew the brass locking nut (5) and lift out the cartridge (6).
- Replace the cartridge (6), the locking nut (5), the cartridge dome (4) and the handle (3).
- Reassemble grub screw (2) and push in decorative cover (1).

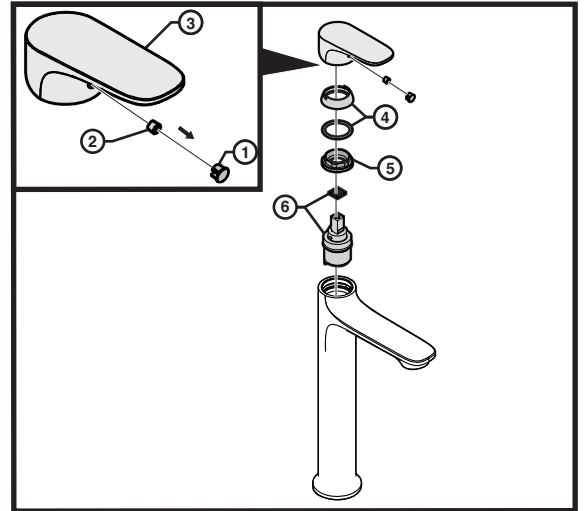

Care Details

We recommend the use of soapy water or approved cleaners. This product should not be cleaned with abrasive materials. Damage caused by any improper treatment is not covered by the product warranty. Refer to Warranty Conditions

Plumbers, please ensure a copy of the installation instruction is left with the end user for future reference.

