



>B< Press Stainless Steel



Contents

1. Key Features	3
2. General	4
3. Technical Data	6
4. Thermal Expansion	7
5. Corrosion Resistance	8
6. Fitting Construction	9
7. Recommended Tools	10
8. Loss Coefficients	14
9. Tube Preparation	16
10. Installation Instructions	17
11. Installation Requirements	18
12. Product Range	19
13. Frequently Asked Questions	22

1. Key Features

Conex Bänninger >B< Press Stainless Steel is a versatile press fitting system for hot and cold drinking water, heating, low pressure steam, cooling and rainwater applications.

>B< Press Stainless Steel fittings are quick to fit, providing a low cost installation solution. The slimline design gives an aesthetically pleasing finish with a secure, permanent, leak-proof joint that can't be tampered with.

>B< Press Stainless Steel fittings are WaterMark approved and certified to AS3688.



Designed for Australia

Developed in partnership with Reece, Conex Bänninger and Rothenberger to meet the specific needs of Australian plumbers.



Tool Service Support

To ensure optimal performance, your Rothenberger press tools can be serviced through the Reece Tool Service Department.



Extensive testing

>B< Press fittings undergo rigorous internal testing to ensure they meet Australian standards and piping tolerances.



Training and Certification

Reece supports you with training and certification as well as expert advice whenever you need it.

Flame Free

Takes away the risk of fire on site and eliminates the need for a hot works permit and heavy equipment.



Lower Installed Cost

A professional fitting which is quick and simple to install, saving time and money.



Higher Productivity

Installation can be completed during working hours or public access by a single employee.



Superior Performance

Corrosion resistant, with a design life of 50 years that can be relied on long after installation.



Permanent Connection

A secure, permanent joint ensures the fitting cannot be tampered with.



Fully Certified

Extensive third-party certification offers peace of mind to the client, specifier and installer.



Leak Indicator

The unique pressing indicator in the O-ring shows leaks at low pressures when fittings are not pressed.



2. General

>B< Press Stainless Steel is a quick and simple to install flame-free fitting, manufactured using high quality hygienic 316 stainless steel material, suitable for multiple applications. >B< Press Stainless Steel is designed with a unique and innovative 3-point press system to ensure a leak-free, secure and permanent joint.

Approvals



Certification

Conex Bänninger is an ISO 9000 quality assured company. In addition to WaterMark approvals in Australia, Conex Bänninger has approvals from numerous national and international bodies including DVGW, KIWA, GASTEC, WRAS and AENOR, plus many well-known others.

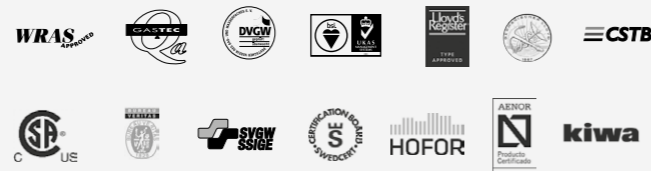

Materials

>B< Press Stainless Steel fittings are made from solution-treated molybdenum-steel 316. These fittings are type tested in accordance with AS 3688 and certified under the WaterMark scheme.

Threads

All >B< Press Stainless Steel threaded fittings comply with EN 10226-1 (ISO 7-1) and are 'thread sealing' (mating conical male thread R / cylindrical female thread Rp).

Sealing Elements

A high quality black elastomer EPDM with a hardness of 70 Shore is used for the sealing elements (O-rings) of >B< Press Stainless Steel fittings. These comply with the requirements of AS/NZS 4020 for use within drinking water systems.

EPDM (ethylene propylene diene monomer) is a synthetic, peroxide-cured rubber. It is age, ozone and chemical resistant with high elasticity, and excellent cold and heat behaviour.

Processing and Assembly

When using >B< Press Stainless Steel fittings, the application parameters on page 6 must be observed.

The use of different materials in a drinking water system must comply with the appropriate codes of practice.

In the design and creation of tube systems, the standard engineering practices for drinking water installations must be adhered to and observed.

Storage and Handling

For the storage and transportation of >B< Press Stainless Steel fittings, it is advisable to leave them in the packaging to conserve the lubrication of the O-rings prior to installations.

Please store in a cool, dry place to protect the fittings from contamination, damage and dirt.

Tube Compatibility

>B< Press Stainless Steel fittings can be used on stainless steel tubes manufactured to AS 5200.053 Series 2.

Electrical Continuity

>B< Press Stainless Steel fittings maintain earth continuity without the need for additional continuity straps.

Recommended Water Velocities

Note: The maximum allowances for water velocities are per the relevant national standards and codes, which includes AS/NZS 3500.

Warranty

A 25 year warranty covers against faults caused by defective manufacture of the fittings. It does not cover faults arising from incorrect installation.

The warranty does not cover any faults arising from competitor fittings used on the same installation nor faults caused by damaged >B< Press Stainless Steel fittings (through excessive pressure, for example) where competitor fittings created non-compliant conditions. All >B< Press Stainless Steel fittings must be installed by a licensed plumber.

3. Technical Data

Conex Bänninger >B< Press Stainless Steel fittings are suitable for use in the following applications.

Application	Comments	Pressure (kPa)	Temperature (°C)
Hot and cold potable water	Australian WaterMark approved. WaterMark certification for all plumbing products is restricted to 1400kPa at 95°C	1600	110
Fire services	Capable of the required test pressure of 1700kPa or 1.5 times the design pressure as specified by AS2419.1	1600	110
Rainwater		1600	Ambient
Pump circulated hot water systems	Compliant with EN12828	1600	110
Chilled water		1000	5
Steam	Low pressure steam equipment	≤100	120
Industrial and process water	Treated, softened, partially de-ionised water with a pH of 6.5 ≤ 9.5	1600	110
Vacuum lines for non-medical purposes		-80	Ambient
Compressed air	Oil concentration <25mg/m ³	1600	60
Hydrogen	May leak at <0.001cm ³ /min	500	70
Argon	For welding	1600	70
Forming gas, dry / welding inert gas	Ar+CO ² (e.g. Cargon)	1600	70
Carbon dioxide (dry gas)		1600	Ambient
Nitrogen (gas)		1600	70
Helium	May leak at <0.001cm ³ /min	1600	70
Oxygen		1000	Ambient
Carbon monoxide		1600	70
Acetone (liquid)		500	-10 to 40
Condensate	From gas condenser boiler or steam	1600	110
Ethanol		1600	25

Not suitable for: Aromatic, aliphatic and chlorinated hydrocarbons, turpentine, petroleum and mineral oils.

4. Thermal Expansion

Effects of Expansion

The coefficient of linear expansion for stainless steel is 16.0 x 10⁻⁶ per °C. For example, a 10m length of stainless steel tube, irrespective of its size, wall thickness or temper, will increase in length by 9.6mm with a temperature rise of 60°C. Tubes installed on hot water services must be free to accommodate this expansion, otherwise stresses will build up in the pipework, which may lead to joints being pulled apart and/or tubes fracturing. The magnitude and frequency of such changes in length will determine the life of the joint or failure of the tube.

Table 1 shows the amount of tube expansion for a given temperature rise. In domestic hot water and heating installations, the limited size of rooms and hence straight tube runs, together with the many bends and offsets that normally occur, will result in thermal movement being accommodated automatically. However, where long straight tube runs exceeding 10 metres are encountered, allowance for expansion should be made.

A quick, economic and effective way of accommodating thermal expansion is to simply incorporate the horseshoe or compensating bend to the system design.

Where stainless steel tubes pass through walls, floors and ceilings, they should be able to move as a result of expansion and contraction. This can be arranged by passing the tube through a sleeve or length of larger diameter tube fixed through the whole thickness of the wall, floor or ceiling, or by means of flexible joints on either side of the wall.

Short stubs to and from radiators, connected to relatively long straight runs should also be avoided. This can usually be achieved by introducing an expansion loop, thereby increasing the length of pipework fixed between the flow/return legs and the radiator connection. However, expansion accommodation techniques such as the use of loops and horseshoes may not be sufficient to accommodate large expansions. In such cases, the use of the bellows type couplers may be necessary.

Expansion Devices

Table 1

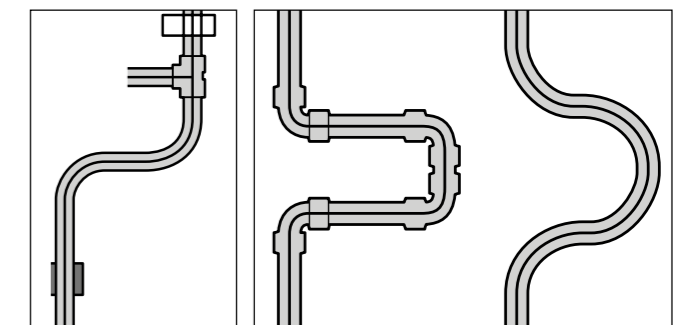

By change of direction Horseshoe or compensating bend

Thermal expansion (mm) of stainless steel tube as a function of tube length and temperature difference.

Table 2 shows the increase in length due to thermal expansion as a function of change in temperature Δt and the length of the tube at the lower temperature, irrespective of temper or wall thickness.

Table 2

Tube Length (m)	Temperature Difference (Δt °C)							
	Δt=30°	Δt=40°	Δt=50°	Δt=60°	Δt=70°	Δt=80°	Δt=90°	Δt=100°
0.1	0.05	0.06	0.08	0.10	0.11	0.13	0.14	0.16
0.2	0.10	0.13	0.16	0.19	0.22	0.26	0.30	0.32
0.3	0.14	0.20	0.24	0.30	0.34	0.40	0.43	0.50
0.4	0.20	0.26	0.32	0.40	0.45	0.50	0.60	0.64
0.5	0.24	0.30	0.40	0.50	0.56	0.64	0.72	0.80
0.6	0.30	0.40	0.50	0.58	0.67	0.77	0.86	0.96
0.7	0.34	0.45	0.56	0.67	0.80	0.90	1.01	1.12
0.8	0.40	0.50	0.64	0.77	0.90	1.02	1.15	1.30
0.9	0.43	0.57	0.72	0.86	1.01	1.15	1.30	1.44
1.0	0.50	0.64	0.80	0.96	1.12	1.30	1.44	1.60
2.0	0.96	1.30	1.60	1.92	2.24	2.60	2.90	3.20
3.0	1.44	1.92	2.40	2.90	3.40	3.84	4.32	4.80
4.0	1.92	2.60	3.20	3.80	4.50	5.12	5.76	6.40
5.0	2.40	3.20	4.00	4.80	5.60	6.40	7.20	8.00
10.0	4.80	6.40	8.00	9.60	11.20	12.80	14.40	16.00
15.0	7.20	9.60	12.00	14.40	16.80	19.20	21.60	24.00
20.0	9.60	12.80	16.00	19.20	22.40	25.60	28.80	32.00
25.0	12.00	16.00	20.00	24.00	28.00	32.00	36.00	40.00

5. Corrosion Resistance

Internal Corrosion

Within a stainless steel pipework system, a passive layer mostly formed from chromic oxide is created upon contact with oxygen or oxygenated water (i.e. drinking water). This layer restricts corrosion from occurring and provides high levels of hygiene, durability and water quality.

If there are chloride levels above those deemed acceptable, a breakdown of the passive layer may occur, allowing corrosion to appear in the form of pitting, crevice or stress corrosion. The established view is that crevice corrosion rarely occurs on grade 316 steel where the concentrations of chloride are under 1000ppm in supply and waste water systems.

It has also been proved that crevice and pitting corrosion increases with temperature, however, for drinking water systems everyday temperatures and chloride levels should not be a problem.

Note: The NHMRC/ARMCANZ guidelines (Australian drinking water guidelines). On the other hand, borehole water may have increased levels of chlorine, meaning more care should be taken to make sure levels are within the tolerable range.

Disinfection and Sterilisation

For the sterilisation process, chlorine of concentrations up to 25ppm during a 24-hour period is acceptable, providing that the lines are

comprehensively flushed with fresh water and that residual chlorine is restricted to <1ppm. It is recommended that this is verified by analysis.

External Corrosion

External corrosion of stainless steel pipework is likely to occur when exposed to high levels of chloride. >B< Press Stainless Steel fittings should not be installed in this situation. However, if there are parts of the system where this is unavoidable, appropriate precautions must be taken to minimise the risk.

Thermal Insulation

The thermal insulations of tubes should be implemented in accordance with national codes and standards including AS 4426.

Connecting to Other Materials

Stainless steel, copper and copper alloys can easily be combined without the risk of corrosion.

Note: Carbon steel should not be directly connected to stainless steel as this will cause corrosion. A spacer connector of brass material should be used to separate the two dissimilar materials by at least 50mm. Flow of water should be in the direction from carbon steel to stainless steel and not vice versa.

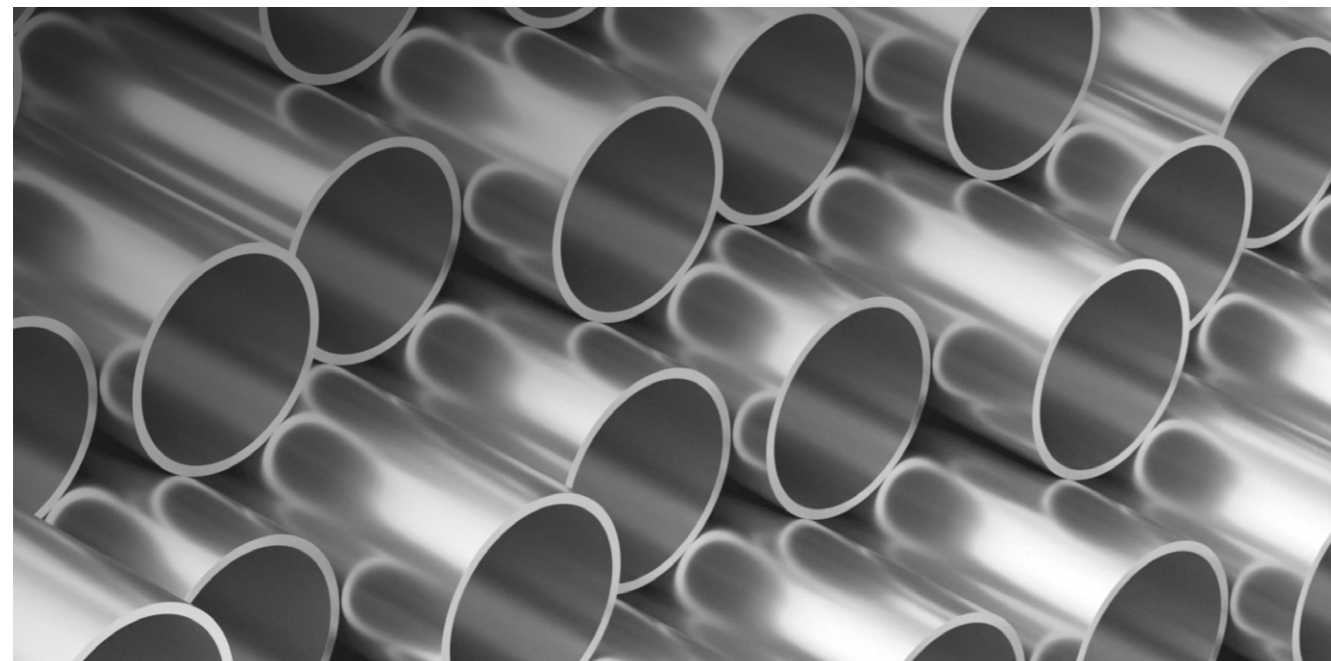

6. Fitting Construction

>B< Press Stainless Steel fittings are made with a 3-point pressing contour. The design incorporates two mechanical presses either side of the bead and one hydraulic press crimping the O-ring.

This 3-point press feature enables a quick and safe installation process. To fit correctly, it is important to ensure that the tube is parallel to the fitting before contact with the O-ring. This reduces the chance of damage to the O-ring during assembly.

Pressing Indicator (PI) Feature

All >B< Press Stainless Steel fittings have a 'unique pressing indicator' that detects unpressed connections.

This is a specially designed O-ring. It has a reduced section in two positions that allows leakage if the joint has not been pressed.

The joint will leak at a pressure between 10 to 500kPa. Any unpressed joints can be identified during the test phase and corrected, saving valuable time and money. There is no need to drain down as the pressing operation can be carried out whilst the water is still in the system.

When the fitting is pressed, the O-ring material compresses to form a permanent, leak free joint.

>B< Press Stainless Steel fittings are installed with a mechanical press tool. A compatible >B< profile jaw to fit each size of fitting is required. When force is exerted through the press tool, the jaw closes to make a permanent joint.

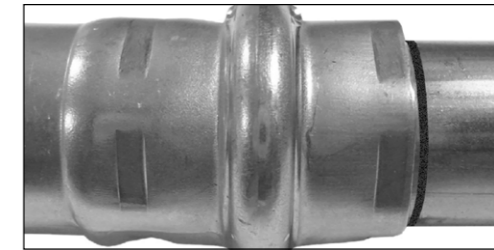

Witness Marks on Fitting



Pressed Fitting



Patented >B< Press Stainless Steel O-ring

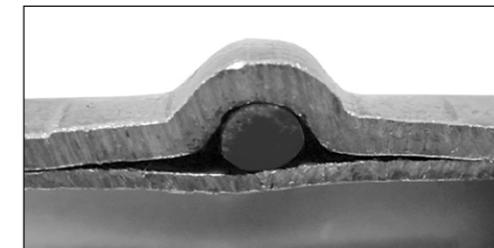

>B< Press Stainless Steel Contour Section

Testing and Commissioning Installations

All fitting connections in a system should remain visible and accessible until leak and pressure tested.

To ensure that all press joints have been successfully completed, a low pressure test is applied as follows:

- After flushing, fill the system with water and check for visible leaks.
- No leak. Apply a test pressure of between 100 and no more than 500kPa.
- No leak. Final testing should be conducted in accordance with AS/NZS 3500.

Stainless steel tubes can be disinfected with hydrogen peroxide H₂O₂, although disinfection with chlorine is possible providing correct guidelines are used.

Stainless steel piping must be protected from external contact with chloride-containing building materials and other aggressive media. In such cases, subsequent corrosion protection should be provided.

Note: It is advised that corrosion protection binding and/or exposure to class A or B heat-shrinkable tubing guidelines must be adhered to.

7. Recommended Tools

Rothenberger press tools and jaws have been specifically engineered for >B< Press Stainless Steel.

With strict Australian piping tolerances, it is imperative that your tool works in unison with your press fittings. Therefore, it is recommended to use Rothenberger press tools when installing >B< Press Stainless Steel for the best press solution.

Rothenberger Romax Compact TT

Application sizes: 15-28mm >B< Press Stainless Steel Fittings



- Compact, lightweight, twin cylinder design – optimised for one hand operation.
- CFT® – technology for constant axial 19kN shearing force.
- Safety latch to ensure jaw cannot come out during operation.
- Easy to use LED status indication – flashing red when battery charge is low and will lock the machine.
- Simple and safe operation design – hold start button – tool automatically stops once press cycle is complete.
- Safety yellow button – press to release pressure and stop press cycle.
- Convenient 20,000 cycle interval between service requirements.
- Head positioning up to 270° rotation – easy fitting in difficult locations.
- Li-Ion battery technology – long lasting operation between charges.
- Patented AIR COOLED charging technology.

Specifications
Battery voltage – 18V
Battery capacity – 2Ah and 4Ah
Max piston force – 19kN
Pressing time – 3 seconds
Dimensions (LxWxH) – 8cm x 14.3cm x 33.6cm
Weight (less jaws) – 2.5kg
Working range: <ul style="list-style-type: none"> • S/S Systems 15 – 28mm
Typical A-rate noise level – 71dB(A)
Battery re-charge time periods <ul style="list-style-type: none"> • 2Ah = 40 minutes • 4Ah = 80 minutes

Rothenberger Romax Compact TT Tool and Jaw Kits	
Product Code	Description
8078100	Rothenberger Compact TT Tool Only
9507360	Rothenberger Compact >B< Press Stainless Steel Jaw Set 15-28mm

Rothenberger Romax 4000

Application sizes: 15 – 54mm >B< Press Stainless Steel Fittings



- Ergonomically designed and better weight distribution compared to the 3000 – reducing fatigue during extended use.
- Wide application range.
- Fast pressing – automatic cycle complete in 4 seconds.
- Easy to use LED status indication – flashing red when battery charge is low and will lock the machine, remains ON when tool has reached 40,000 cycles of use and requires servicing.
- Bright white light LEDs to illuminate work space during pressing cycle.
- Simple and safe operation design – hold start button – tool automatically stops once press cycle is complete.
- Safety yellow button – press to release pressure and stop press cycle.
- Long 40,000 cycle interval between service requirements.
- Head positioning up to 270° rotation – easy fitting in difficult locations.
- Li-Ion battery technology – long lasting operation between charges.

Specifications
Battery voltage – 18V
Battery capacity – 2Ah and 4Ah
Rated power consumption – 540 Watts
Max piston force – 32kN
Pressing time – 4 secs (nominal)
Dimensions (LxWxH) – 447x125x75mm
Weight (less jaws) – 3.54kg
Working range: <ul style="list-style-type: none"> • S/S Systems 15 – 54mm
Typical A-rate noise level – 71dB(A)
Battery re-charge time periods <ul style="list-style-type: none"> • 2Ah = 40 minutes • 4Ah = 80 minutes

Rothenberger Romax 4000 Tool and Jaw Kits	
Product Code	Description
7701304	Rothenberger 4000 Tool Only 18V
9507368	Rothenberger 3000/4000 >B< Press Stainless Steel Jaw Set 15-28mm
9508158	Rothenberger 3000/4000 >B< Press Stainless Steel Jaw Set 15-54mm

Critical Operating Instructions - Tool and Jaw

Only operate the Rothenberger press tool and jaws as per instructions in your 'User Operating Manual, Instructions for Use'. Proper usage includes compliance with the operating manual, inspection and servicing conditions and adherence to all relevant safety regulations. The equipment must only be used by qualified tradespeople that have a trained understanding on how to use the press tool and jaw system properly. Failure to do so will lead to safety risk, poor workmanship, and incorrect use of the press tool and jaw that is not covered under warranty. Only use Rothenberger press tools and jaws with compatible press fittings that have been tested and approved by Rothenberger and associated fitting and pipe manufacturers (>B< Press, Auspex, Duopex).

- Always start with a safety check, reminding yourself of the yellow emergency stop button to deactivate a press cycle.
- Charge battery fully before first use for optimal number of 'presses per charge'.
- LED flashes red to indicate when you have a flat battery.
- Insert battery correctly until it clicks into place and LED light flashes briefly to indicate contact made.
- Insert press jaw and close bolt down correctly. Only use the correct jaw to tool to fitting combination.
- Open the jaw by squeezing from the base of the jaw NOT the front tip (it can crush your fingers!).
- Place jaw squarely on fitting. Align with bead.
- Half engage the start button for the handy LED lights.
- Fully engage the start button for a full press cycle. Activate the press tool and jaw only on a fitting.
- Take the time to ensure the correct pipe preparation – cut pipe square, deburr, remove sharp edges and mark insertion depth. These pipe prep steps are critical for a correct press and quality workmanship.
- Follow all installation instructions supplied by the fitting and pipe manufacturers. Imperfect pipe joints must only be pressed again using a new fitting, DO NOT re-press the same fitting.
- During the press cycle, visually check that the press jaw fully closes at the end of the press cycle.
- After pressing, check the installation with appropriate testing equipment and ensure it is leak-proof.

Regular Maintenance Instructions - Tool and Jaw

Tool – Always clean and grease and store in case

Your Rothenberger Tool is one of the lightest and most ergonomic designed tools that delivers the most consistent press force (CFT® - Constant Force Technology). With regular maintenance and service it generates up to 3.2 tonnes of force in your hand, so it requires regular care and maintenance.



1. Clean and grease the piston ram and drive rolls ALWAYS after every use to maintain performance – especially the internal guide rail OR all the 'moving metallic parts'.
- Watch heavy water areas. Do not expose power tools to rain or wet conditions. Always store in case.



2. Ensure the jaw locking bolt is closed correctly by fully inserting the bolt through the jaw and rotating the bolt arm down 180 degrees.
- **Note:** The bolt is only secured when fully inserted and rotated into the downward position.

Battery – Always clean contact points and store in a charged state



1. Clean contact points on battery and only store battery in a charged state, plus it's always ready for use.
- Do not force the press tool – it will do the job better and safer at the rate for which it was designed.
- Accidents are caused by poorly maintained press tools and jaws. Take the time to maintain properly.

Jaws – Always clean, apply lubricant spray and store in case



2. Clean jaws ALWAYS after every use. Keep the inside jaw profile free of any grease and grit.
- Jaws must be maintained with liquid lubricant spray. Do not use spray on the tool, only the jaws.
- Ensure any excess spray is removed. Always store in case.

Servicing and Warranty - Tool and Jaw



Rothenberger prides itself on leading edge design, the highest quality, and leading after sales service support. With ownership of your Rothenberger tool comes our commitment to support you. We want to help you look after your tool, so you don't compromise your reputation.





- Simply return your Rothenberger press tool and jaw set to your local Reece branch – they will sort out the rest.
- A qualified tool service technician will inspect and service your tool to ensure high performance and safety.
- Comprehensive spare parts are readily available locally to support your Rothenberger tool and jaws.
- Jaws will also be checked at the annual service interval for any damage, defects and general wear and tear that could affect the press performance or safety.

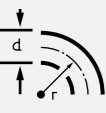
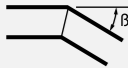

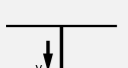
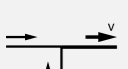
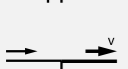
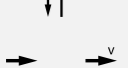
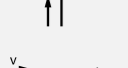
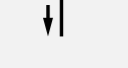

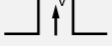
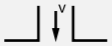
Warranty Coverage

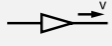
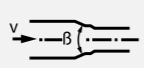
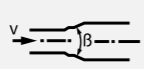

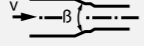
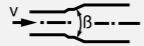

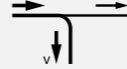
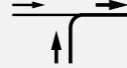
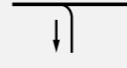
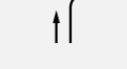

- After 1 year or 20,000 (Romax Compact/Compact TT) or 40,000 presses (Romax 3000/4000), the LED lights up red after each press.
- A press cycle count will be made as part of your annual tool and jaw servicing and report.
- If a serial number sticker is damaged, the warranty will be null and void.
- The warranty does not cover damage caused by incorrect use of the equipment.
- Tool 4 years, only with regular 1 year or cycle count servicing (like servicing your car!).
- Battery 12 months, Jaws 12 months.

8. Loss Coefficients

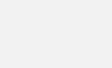
Symbol	Designation	ζ	Application	
			DW	H
	Angle or elbow reference value in accordance with DIN 1988 T3	0.70	X	X
	Angle 90° r/d (r/d = 1.2 with fittings complying with DIN EN 1254)	= 0.5 = 1.0 = 2.0 = 3.0	1.0 0.35 0.20 0.15	X X X X
	Angle $\beta = 90^\circ$ $\beta = 60^\circ$ $\beta = 45^\circ$	1.3 0.8 0.4	X X X	X X X
	Crossover	0.5	X	X
	Branch, square flow separation	1.3	X	X
	Flow merging	0.9	X	X
	Clearance at flow merging	0.3	X	X
	Clearance at flow merging	0.6	X	X
	Counter-flow at flow merging	3.0	X	X
	Counter-flow at flow separation	1.5	X	X

Symbol	Designation	ζ	Application	
			DW	H
	Distributor outlet	0.5	X	X
	Collective inlet	1.0	X	X
	Reservoir outlet	0.5	X	
	Inlet	1.0	X	X
	Reducer	0.4	X	X
	Constriction β - constant =	30° 45° 60°	0.02 0.04 0.07	X X X
	Expansion β - constant =	10° 20° 30° 40°	0.10 0.15 0.20 0.20	X X X X
	Expansion bends	1.0	X	X
	Compensator	2.0	X	X
	Compensator	2.0	X	X

Symbol	Designation	ζ	Application	
			DW	H
	Branch, curved flow separation	0.9	X	X
	Flow merging	0.4	X	X
	Clearance at flow separation	0.3	X	X
	Clearance at flow merging	0.2	X	X
	Angle valves DN 10 DN 15 DN 20 to DN 50 DN 65 to DN 100	7.0 4.0 2.0 3.5 4.0	X X X X X	X X X X X
	Diaphragm valves DN 15 DN 20 DN 25 to DN 32 DN 40 to DN 100	10.0 8.5 7.0 6.0 5.0	X X X X X	X X X X X
	Shutter valves Piston valves Ball valves DN 10 to DN 15 DN 20 to DN 25 DN 32 to DN 150	1.0 0.5 0.3	X X X	X X X
	Radiator valves	4.0		X
	Control valve	2.0		X
	Pressure regulator fully open	30.0		X

Symbol	Designation	ζ	Application	
			DW	H
	Shut-off valve Straight seat valve DN 15 DN 20 DN 25 DN 32 DN 40 to DN 100	10.0 8.5 7.0 6.0 5.0	X X X X X	X X X X X
	Angle seat valve DN 15 DN 20 DN 25 to DN50 DN 65	3.5 2.5 2.0 0.7	X X X X	X X X X
	Return flow inhibitor DN 15 to DN 20 DN 25 to DN 40 DN 50 DN 65 to DN 100	7.7 4.3 3.8 2.5	X X X X	
	Control valve with return flow inhibitor DN 20 DN 25 to DN 50	6.0 5.0	X X	
	Valve tapping sleeve DN 25 to DN 80	5.0	X	
	Boiler	2.5		X
	Heating radiator	2.5		X
	Panel radiator	3.0		X

9. Tube Preparation

Correct tube preparation is essential for problem free installation, just follow these straightforward guidelines.

Incorrect tube preparation can damage the O-ring and cause the fittings to leak.

Note: Grinding wheels and hacksaws are not suitable for cutting the tube. If the tube ends become distorted, remove the damaged section using the appropriate cutting method.

When preparing tube, ensure that the tube is correctly supported and eye protection is worn.

Tube Cutting

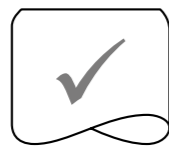

Domed

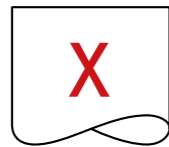

Sharp edge

- Cut the tube square using a rotary tube cutter. We recommend using the Rothenberger stainless steel tube cutter, a suitable tube cutting machine with the correct cutting wheel.
- Cut tube ends should be clean and free from scratches with no sharp edges.

Tube Deburring

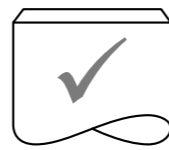

Chamfer

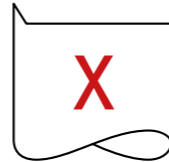

Burrs



- Make sure that the internal and external tube end is free from burrs or sharp edges, by using a deburring tool in one direction clockwise to prevent damage to the O-ring.
- If a deburrer is not available, then a fine file can be used to remove the sharp edges.

10. Installation Instructions

It is advisable to leave the fittings in the packaging prior to final installation to protect them from contamination and to conserve the lubrication of the O-rings.

To install >B< Press Stainless Steel fittings, a Rothenberger Romax mechanical tool with a compatible sized jaw to fit is required. When force is exerted through the press tool, a permanent joint is made and the fitting cannot be disassembled or reused.

Hot bending of stainless steel tubes is not allowed as it will adversely affect the composition of the stainless steel, compromising performance.

Stainless tubes up to and including 28mm must be cold bent with suitable bending tools. Larger size tubes are not to be bent. A bending radius, measured in the neutral axis of the bend, of at least $R = 3.5D$ is to be maintained, where R is the radius and D is the tube diameter.

It is to be ensured that, after bending, a sufficiently long, straight cylindrical tube piece is available for further processing.



Step 1 – Cut the tube to length

- We recommend you use a Rothenberger stainless steel tube cutter. It is important to ensure that the tube is cut completely square.
- Tube ends should be clean and free from scratches not less than the socket length. Check the tube has retained its shape.

Note: The tube cutter shall not have been used for cutting carbon steel/ferrous metals. Failure to ensure this may result in a corrosion failure point.



Step 2 – Remove burrs

- Make sure that the internal and external tube end is free from burrs or sharp edges by using a deburring tool in one direction clockwise to prevent damage to the O-ring.
- Then wipe the tube end clean to avoid damaging the O-ring on tube insertion.



Step 3 – Check the fitting

- Inspect the fitting, checking the O-rings are present and correctly seated and that the fitting is the correct size for the tube.



Step 4 – Mark the insertion depth

- The tube must be fully inserted into the fitting until it reaches the tube stop in order to make a perfect joint.
- Marking insertion depth will ensure that any tube movement is detected, which is especially important if the joints are to be pressed at a later time.

Note: Do not measure the socket depth, but push the tube into the fitting then mark the tube.



Step 5 – Assemble the tube and fitting

- To assemble the joint, the tube must be inserted into the fitting up to the tube stop. (Use the mark on the tube which was made earlier as reference). The pressing operation should only be undertaken when the tube reaches the tube stop.



Step 6 – Complete the joint with the press tool

- Ensure that the correct size jaw for the fitting is inserted into the tool. The jaws must be placed square on the fitting.
- Depress the trigger/button to begin the compression cycle of the tool. This is complete when the mouth of the fitting is fully enclosed by the jaws.
- Now release the jaws from around the fitting. (For further information, refer to complete Romax instructions.)

Note: The >B< Press Stainless Steel joint is complete after one complete compression cycle of the tool. Do not crimp any >B< Press Stainless Steel fitting more than once.

11. Installation Requirements

Distance between fittings

Due to the reforming of the tube profile when pressed, it is advised that a minimum distance is allowed between each fitting.

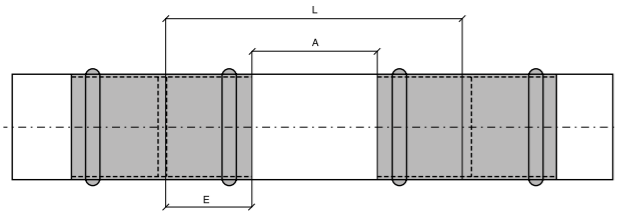

Size	Nominal External Ø Tube	Minimum Distance	Minimum Tube Length	Insertion Depth
	mm	A - mm	L - mm	E - mm
15	15	10	54	22
22	22	20	66	23
28	28	20	68	24
35	35	25	79	28
42	42	30	102	36
54	54	35	116	41

Minimum clearance requirements

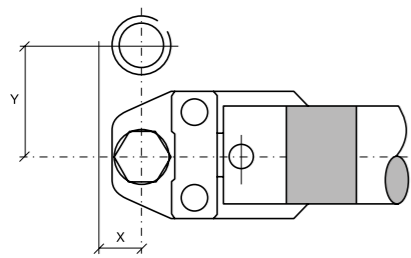

Space required for the pressing process between tubes		
External Tube	X	Y
mm	mm	mm
15	26	53
22	26	56
28	33	69
35	33	73
42	75	115
54	85	120

Tube dimensions

Table 1 – AS 5200.053 Series 2.
Dimensions of light gauge stainless steel tubes – Series 2

Specified Outside Diameter D	Specified Wall Thickness T	Tolerance on T
mm	mm	mm
15	1.0	± 0.10
18	1.0	± 0.10
22	1.2	± 0.10
28	1.2	± 0.10
35	1.5	± 0.10
42	1.5	± 0.10
54	1.5	± 0.10

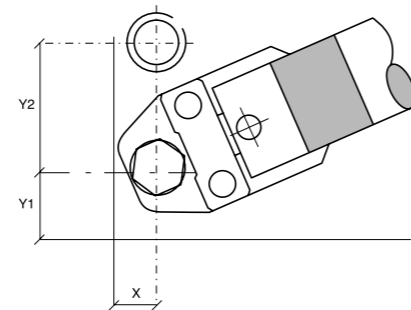

Space required for the pressing process between tubes			
External Tube	X	Y1	Y2
mm	mm	mm	mm
15	31	45	73
22	31	45	76
28	38	55	80
35	38	55	85
42	75	75	115
54	85	85	140

12. Product Range

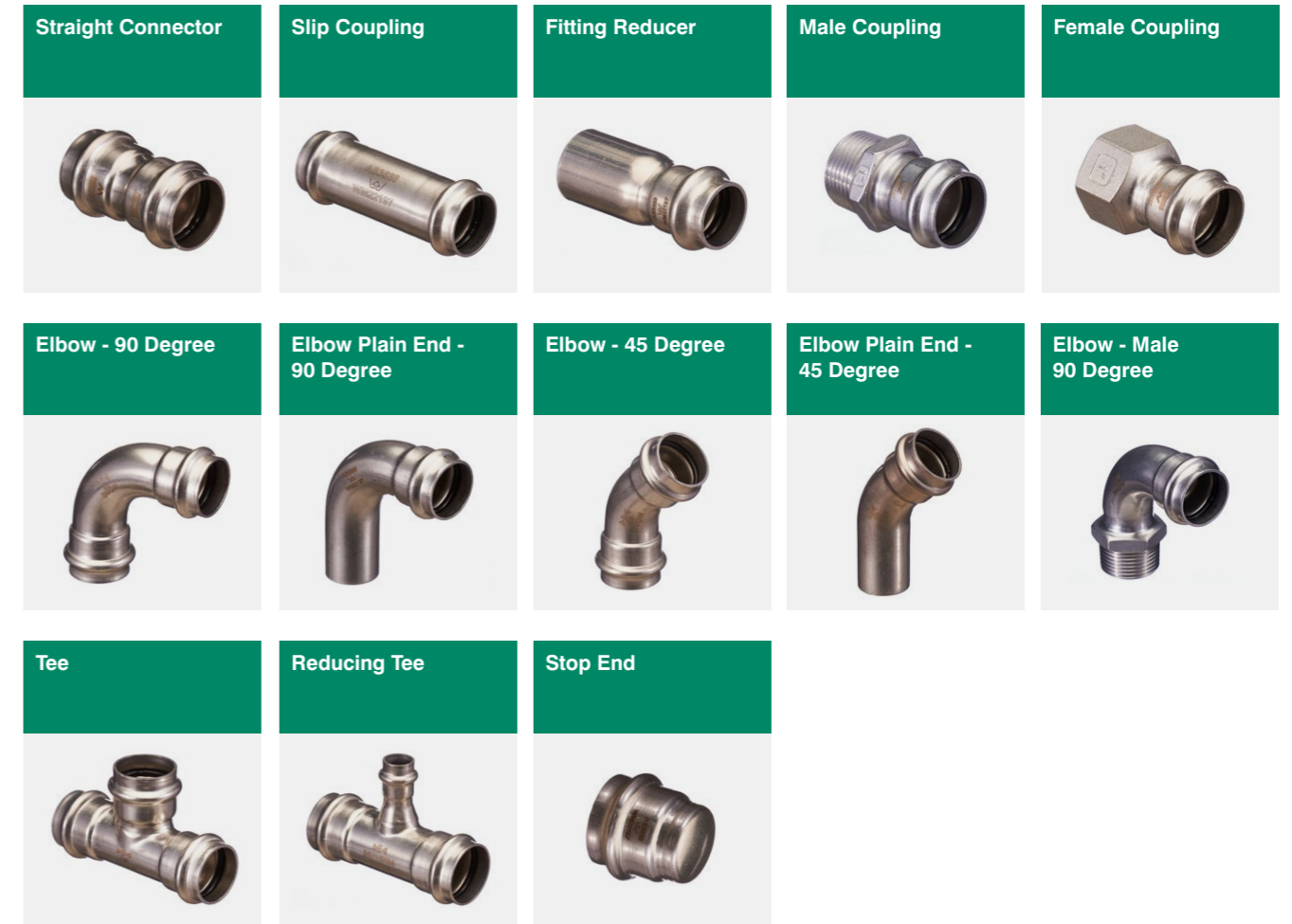

Straight Connector				
Product Code	Size	L	Z	
1117978	15mm	54	10	
1117980	22mm	56	10	
1117981	28mm	58	10	
1117982	35mm	66	10	
1117983	42mm	87	15	
1117984	54mm	98	16	

Slip Coupling			
Product Code	Size	L	
1117863	15mm	80	
1117865	22mm	85	
1117866	28mm	95	
1117867	35mm	105	
1117868	42mm	120	
1117869	54mm	135	

Fitting Reducer

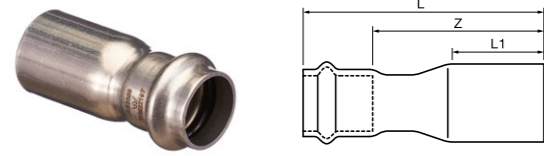

Product Code	Size	L	L1	Z
1117965	22 x 15mm	70	30	48
1117967	28 x 15mm	77	31	55
1117969	28 x 22mm	90	34	67
1117971	35 x 22mm	76	34	53
1117972	35 x 28mm	72	34	48
1117973	42 x 28mm	92	44	68
1117974	42 x 35mm	85	44	58
1117975	54 x 28mm	112	48	89
1117976	54 x 35mm	106	48	79
1117977	54 x 42mm	108	48	70

Male Coupling

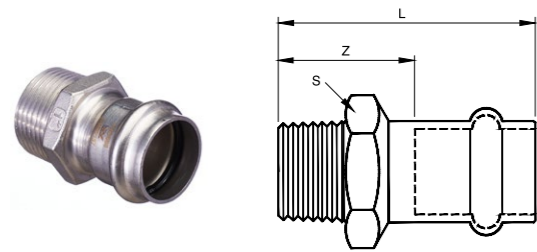

Product Code	Size	L	Z	S
1117841	15mm x 1/2"	54	32	22
1117844	22mm x 1/2"	56	32	22
1117845	22mm x 3/4"	57	34	28
1117846	22mm x 1"	60	37	36
1117847	28mm x 3/4"	58	34	28
1117848	28mm x 1"	61	37	36
1117849	35mm x 1 1/4"	71	41	43
1117850	42mm x 1 1/2"	79	44	50
1117851	54mm x 2"	92	51	62

Female Coupling

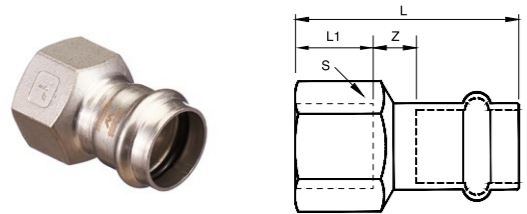

Product Code	Size	L	L1	Z	S
1117852	15mm x 1/2"	50	15	26	13
1117855	22mm x 1/2"	51	15	26	13
1117856	22mm x 3/4"	53	16	31	14
1117857	22mm x 1"	57	19	39	15
1117858	28mm x 3/4"	53	16	31	13
1117859	28mm x 1"	58	19	39	15
1117860	35mm x 1 1/4"	67	21	48	17
1117861	42mm x 1 1/2"	77	21	55	20
1117862	54mm x 2"	88	26	67	20

Elbow - 90 Degree

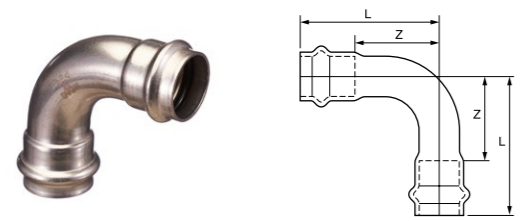

Product Code	Size	L	Z
1117904	15mm	46	24
1117906	22mm	55	32
1117907	28mm	66	42
1117908	35mm	78	51
1117909	42mm	100	64
1117910	54mm	120	79

Elbow Plain End - 90 Degree

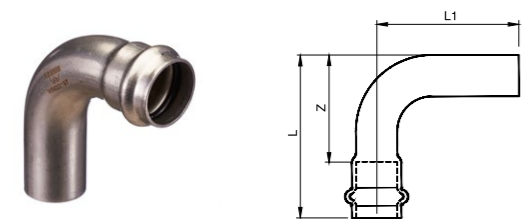

Product Code	Size	L	L1	Z
1117897	15mm	46	53	24
1117898	18mm	50	57	28
1117899	22mm	55	63	32
1117900	28mm	66	74	42
1117901	35mm	78	85	51
1117902	42mm	100	108	64
1117903	54mm	120	125	79

Elbow - 45 Degree

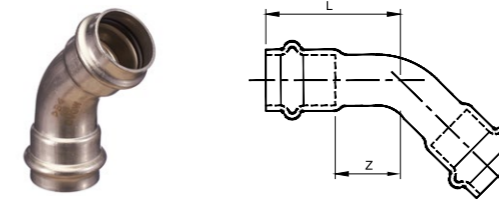

Product Code	Size	L	Z
1117925	15mm	35	13
1117927	22mm	40	17
1117928	28mm	45	21
1117929	35mm	52	25
1117930	42mm	70	34
1117931	54mm	80	39

Elbow Plain End - 45 Degree

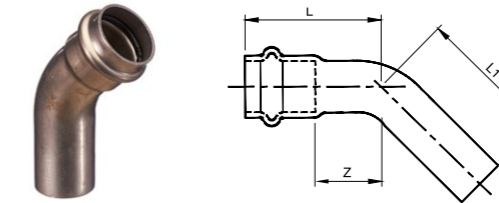

Product Code	Size	L	L1	Z
1117918	15mm	35	42	13
1117920	22mm	40	47	17
1117921	28mm	45	53	21
1117922	35mm	52	59	25
1117923	42mm	70	74	34
1117924	54mm	80	86	39

Elbow - Male 90 Degree

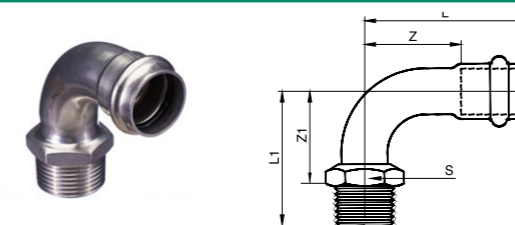

Product Code	Size	L	L1	Z	Z1	S
1117800	15mm x 1/2"	46	47	24	34	22
1117803	22mm x 3/4"	55	56	32	41	28
1117804	28mm x 1"	66	66	42	49	36
1117805	35mm x 1 1/4"	78	78	51	59	43
1117806	42mm x 1 1/2"	86	86	64	67	50
1117807	54mm x 2"	107	107	79	83	62

Tee

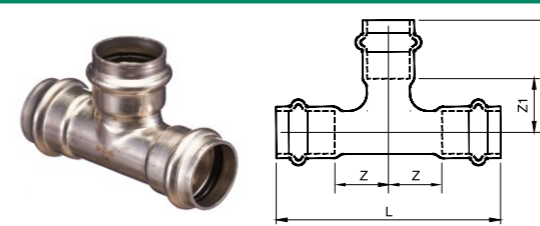

Product Code	Size	L	Z	L1	Z1
1117940	15mm	82	22	39	14
1117945	22mm	88	24	45	19
1117949	28mm	96	28	50	22
1117954	35mm	111	31	56	25
1117958	42mm	134	36	71	30
1117963	54mm	159	41	82	36

Reducing Tee

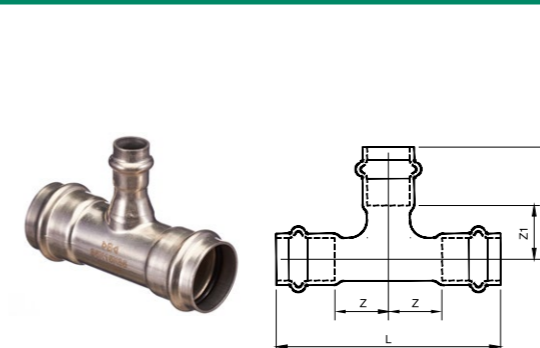

Product Code	Size	L	Z	L1	Z1
1117943	22 x 15 x 22mm	88	21	41	19
1117946	28 x 15 x 28mm	96	24	54	32
1117948	28 x 22 x 28mm	96	24	44	21
1117950	35 x 15 x 35mm	111	27	57	35
1117952	35 x 22 x 35mm	111	27	48	25
1117953	35 x 28 x 35mm	111	27	49	25
1117955	42 x 22 x 42mm	134	30	51	28
1117956	42 x 28 x 42mm	134	30	52	28
1117959	54 x 22 x 54mm	159	36	57	34
1117960	54 x 28 x 54mm	159	36	58	34
1117961	54 x 35 x 54mm	159	36	64	34
1117962	54 x 42 x 54mm	159	36	77	36

Stop End

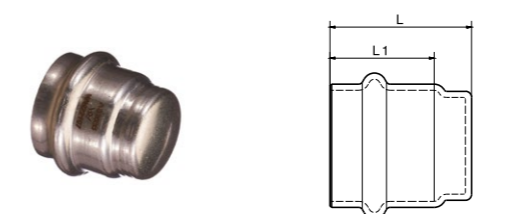

Product Code	Size	L	L1
1117985	15mm	34	22
1117987	22mm	37	23
1117988	28mm	38	24
1117989	35mm	43	27
1117990	42mm	55	36
1117991	54mm	59	41

13. Frequently Asked Questions

Q. How long has Conex Bänninger been around?

A. Since 1909.

Q. Where are the products manufactured?

A. Poland and Spain.

Q. Can you rotate a >B< Press Stainless Steel fitting once installed?

A. No, once pressed, they cannot be rotated.

Q. Can >B< Press Stainless Steel be dismantled and reused?

A. No, this is a permanent installation.

Q. What tube preparation is involved when installing >B< Press Stainless Steel?

A. For instructions on how to prepare tube, please see page 16.

Q. How do you install >B< Press Stainless Steel fittings?

A. Please see 'Installation Instructions' section on page 17.

Q. What pressure do you need to test to and for how long to show any leaks?

A. Unpressed fittings are identified by pressurising the system with a pressure range of 100kPa to 500kPa for water. Final testing of the system should be conducted in accordance with AS/NZS 3500.

Q. Can it be exposed to direct sunlight and heat?

A. Yes – please see table on page 6 for limitations due to pressure and temperature.

Q. Does the clipping of fittings/jobs differ from a welded copper application?

A. No, the same type of clips can be used.

Q. What is the recommended space between fittings?

A. Please see 'Distance between fittings' section on page 18.

Q. What are the benefits of >B< Press fittings?

A. >B< Press Stainless Steel is a flame-free solution, that is fast, simple and reliable to install. Please see 'Key Features' section on page 3.

Q. Can the fittings handle suction or negative pressure?

A. Yes, >B< Press Stainless Steel fittings are tested at a vacuum test pressure of -80kPa at ambient temperature.

Q. Can >B< Press Stainless Steel be installed on pipes where the mains line won't shut off?

A. Yes, fittings can be used in wet conditions and after pressing, will provide a watertight joint.

Q. Do I need to lubricate the O-ring?

A. No, the O-ring is prelubricated. Additional lubricants could impact on the life of the O-ring and void the warranty. If the O-ring appears dry, a small amount of water can be used to lubricate it.

Q. What applications can >B< Press Stainless Steel be used in?

A. >B< Press Stainless Steel fittings are suitable for use across a wide range of applications, depending on medium, temperature and pressure. Please see 'Technical Data' section on page 6.

Q. Is >B< Press Stainless Steel certified for use in potable water systems?

A. Yes >B< Press Stainless Steel is WaterMark certified by IAPMO R&T Oceana.

Q. What stainless steel tubes can >B< Press Stainless Steel be used with?

A. >B< Press Stainless Steel fittings can be used with all stainless steel tubes that comply with AS 5200.053 Series 2.

Q. Is >B< Press Stainless Steel the same as >B< Press Inox?

A. Yes, in markets other than Australia, >B< Press Stainless Steel is trademarked and known as >B< Press Inox.

Q. What other materials can be connected with stainless steel system?

A. Stainless steel, copper and copper alloys can be combined without the risk of corrosion.
*Note: Carbon steel should not be directly connected to stainless steel as this will cause corrosion. A spacer connector of brass material should be used to separate the two dissimilar materials by at least 50mm. Flow of water should be in the direction from carbon steel to stainless steel and not vice versa.

Q. What material is the O-ring made of?

A. The O-ring is manufactured from a high quality black elastomer EPDM with a hardness of 70 Shore. The O-rings comply with the requirements of AS/NZS 4020 for use within drinking water systems.

Q. How should >B< Press Stainless Steel fittings be stored?

A. Fittings should be stored in a cool, dry place in their original packaging. This protects the fittings from contamination, damage and dirt and conserves the lubrication on the O-rings prior to installation.

Q. If a fitting leaks on installation, can you weld the fitting rather than cutting out the joint and having to replace missing tube?

A. No, if a fitting that has been pressed is leaking, the fitting must be cut out and replaced. You should not attempt to weld the fitting as you will melt the O-ring, destroying the sealing element.

Q. Are there concerns with internal corrosion in stainless steel pipework?

A. Within a stainless steel pipework system a passive layer, mostly formed from chromic oxide is created upon contact with oxygen or oxygenated water (i.e. drinking water). This layer restricts corrosion from occurring and provides high levels of hygiene, durability and water quality. For information relating to chloride levels and corrosion, please see page 8.

Q. Are there any concerns with external corrosion in stainless steel pipework?

A. External corrosion of stainless steel pipework is likely to occur when exposed to high levels of chloride. >B< Press Stainless Steel fittings should not be installed in this situation. However, if there are parts of the system where this is unavoidable, appropriate precautions must be taken to minimise the risk.

Q. Can the fittings be used with medical gas?

A. No, >B< Press Stainless Steel is not suitable for medical gas applications.

Q. Can you press a fitting more than once?

A. No, >B< Press Stainless Steel fittings can be pressed only once.

Q. When pressed on small size fittings, (particularly elbows) a small amount of rotational movement can be induced to the joint. Will this affect the security of the joint?

A. No, some rotational movement is quite acceptable, the joint will not leak nor will it come apart under the pressure loading and during system operation. Some joint movement is good as it will allow for expansion and contraction in the pipework system.

Q. What is the warranty on >B< Press Stainless Steel fittings?

A. >B< Press Stainless Steel has a 25 year warranty from the date of purchase. This covers against faults caused by defective manufacture of fittings. It does not cover faults arising from incorrect installation. All >B< Press Stainless Steel fittings must be installed by a licensed plumber.



For more information, visit
www.conexbanninger.com.au

Download this guide:



Reece. Works for you.™

Call **1800 032 566** or visit www.reece.com.au for your nearest Reece store.

The manufacturer/distributor reserves the right to vary specifications or delete models from their range without prior notification. The manufacturer/distributor takes no responsibility for printing errors. All measurement and content details in this brochure are subject to a tolerance of $\pm 3\%$.

[BROCHURE CODE 2131612] V3

Conex | Bänninger
EXCELLENCE SINCE 1909

