

Solus All Door 750 Floor & Wall Mounted Vanity Unit

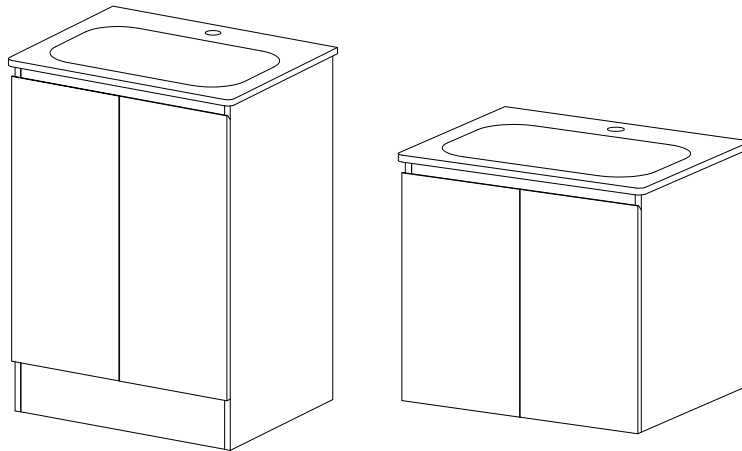

Check



Prior to installation it is important to unpack & inspect your products to ensure no damage has occurred in transit and that the product IS CORRECT. If damage has occurred, or a visible defect exists, do not proceed with installation and contact supplier IMMEDIATELY.

Installation Instructions

1. Check that wall is level and plumb both vertically and horizontally. If your wall is out of plumb, or is not flat, you will need to pack your vanity so as not to follow the wall. Your vanity must be level, otherwise it will twist and your doors and drawers will be out of alignment.
2. Mark base and back of vanity for drilling to allow for plumbing pipes.
3. Drill holes for pipes with appropriate size hole saw.
4. Position vanity over pipes in correct position. It may be an idea to use a level support / noggin to assist in levelling a wall hung unit and help identify any un-plumb surfaces which may require packing prior to fixing the unit to the wall.
5. Check with spirit level that the vanity unit is completely level.
6. Fix vanity to wall through back of vanity ensuring the correct screw/dynabolt size is used by the installer to suit the installation situation.
Where studs cannot be located, it is recommended to use toggle bolts or appropriate hollow-wall fixings. Allow enough fixing points, evenly spaced at the top AND bottom of the back panel, to sufficiently hold the particular unit size onto the situation of the installation area. It may be handy to apply some silicone/adhesive to the rear of the unit prior to fixing, this may assist in levelling and fixing the unit to the wall.
7. Adjust doors and drawers if required as there may have been some movement during transportation and installation. (refer instructions included in unit)
8. Once vanity cabinet is in final position affix vanity top onto cabinet by applying thin bead of silicone on top edge of vanity. Evenly place vanity top onto vanity and firmly press down. Clean of any excess sealant.
9. All edges where vanity top and cabinet meet wall and floor are to be sealed with silicone. Gap filler sealant can be used in place of silicone where unit meets tiled surfaces. All areas need to be sealed to prevent water penetration. Materials used for construction of this unit are water resistant NOT water proof. Care must be taken to dry any spillage or leakage of water which may gain access to cabinet. It is recommended that vanities are installed over 300mm from any wet areas such as baths, spas and showers.

Solus All Door 750 Floor & Wall Mounted Vanity Unit

Floor Mounted

Parts Supplied

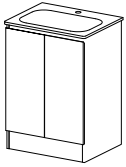

Cabinet x1



Shelf x1

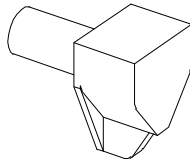

Shelf Support x4

Installation

- (A) Cabinet
- (B) Shelf
- (C) Shelf Support

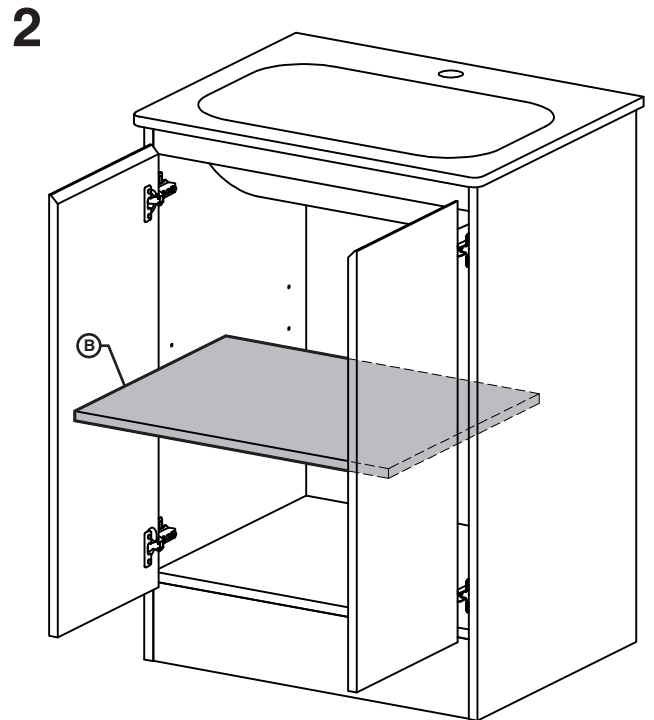
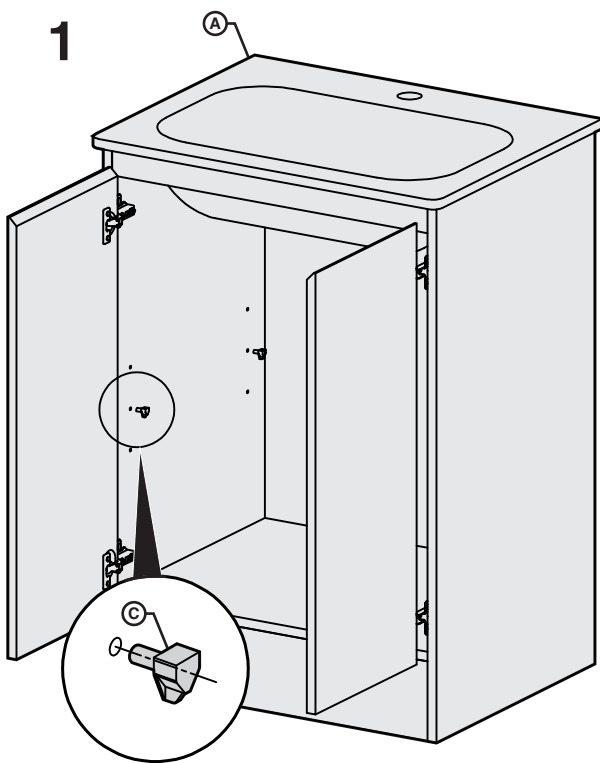

Solus All Door 750 Floor & Wall Mounted Vanity Unit

Wall Mounted

Parts Supplied

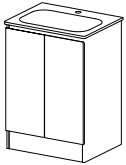

Cabinet x1



Shelf x1

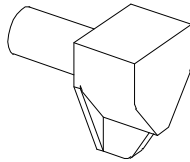

Shelf Support x4



Back Rail x1

Installation

- (A) Cabinet
- (B) Shelf
- (C) Shelf Support
- (D) Back Rail

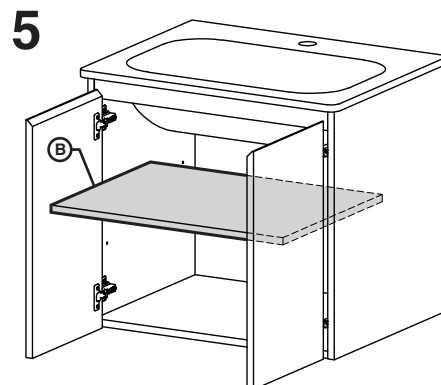
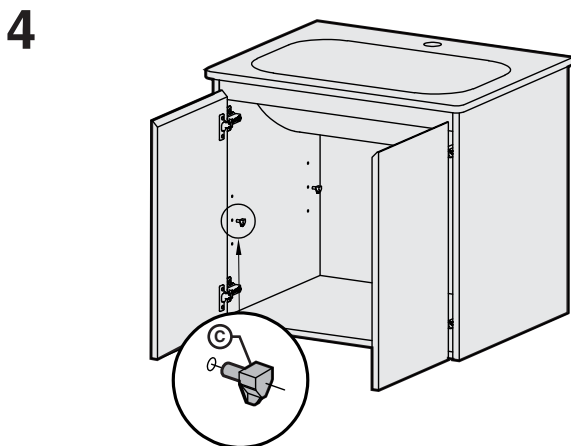
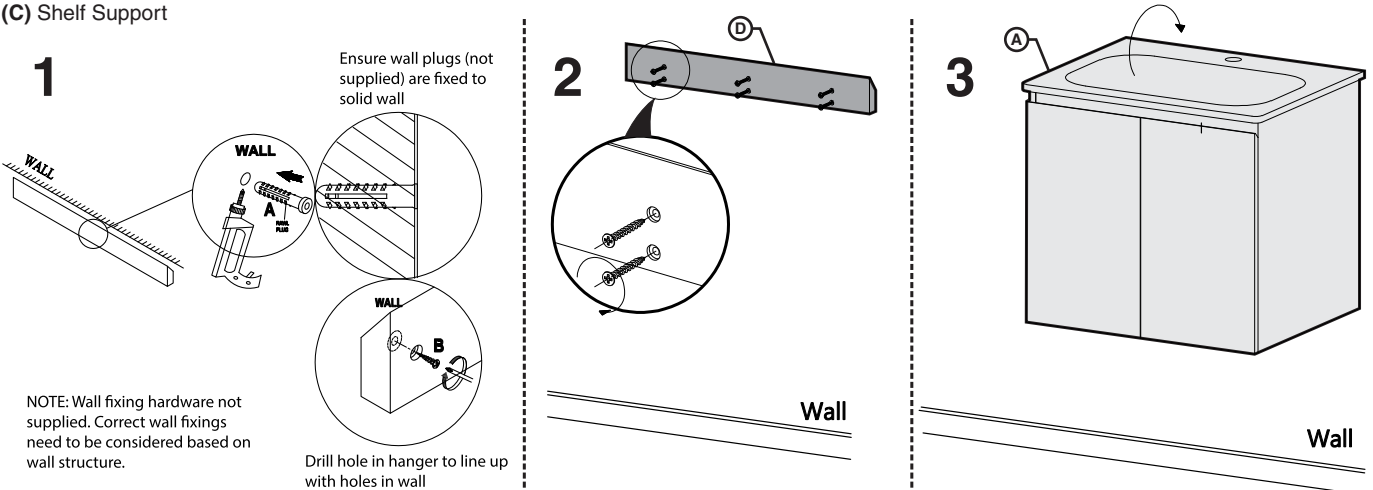

Solus All Door 750 Floor & Wall Mounted Vanity Unit

Door Hinge Adjustments

- Depth Adjustment

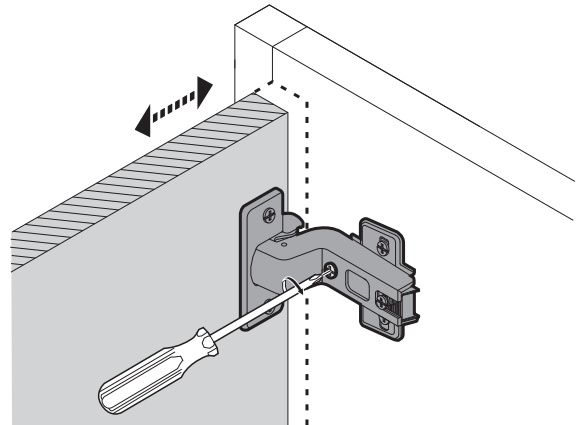

- Lateral Adjustment

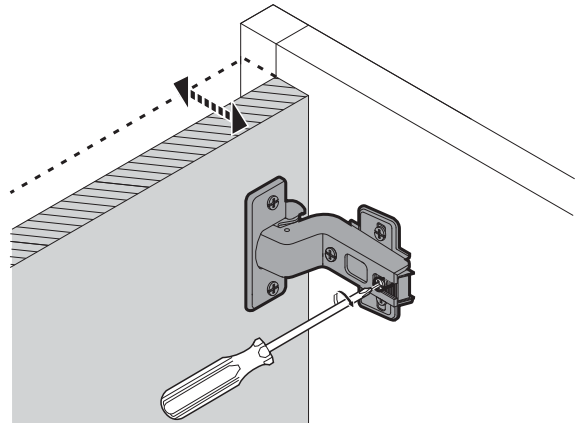

- Vertical Adjustment

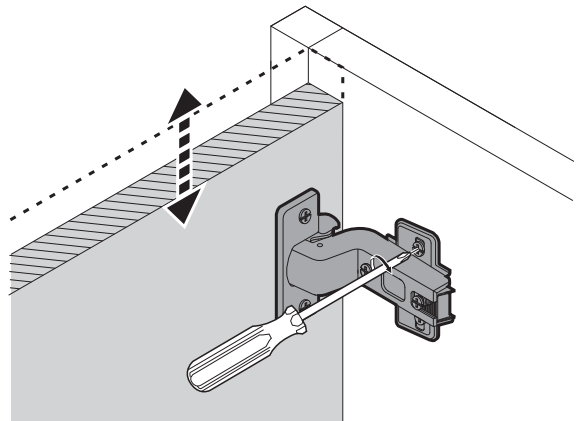

Care Details

We recommend the use of soapy water or approved cleaners. This product should not be cleaned with abrasive materials. Damage caused by any improper treatment is not covered by the product warranty - refer to Warranty Conditions on the last page.

Plumbers, please ensure a copy of the installation instruction is left with the end user for future reference.