

COOL-FIT 2.0

The revolution for efficient cooling



COOL-FIT 2.0

Your solution for chilled water

The efficiency of a cooling plant is defined by the system's Coefficient of Performance (COP), the heat transfer rate at the air cooler and the efficiency of the chilled water piping system. As a contribution to the worldwide initiative to reduce CO₂ emissions and their environmental impact, GF Piping Systems brings a revolution to efficient cooling.



The COOL-FIT 2.0 PE100 pipes and fittings are insulated with 22 mm of high energy efficient (HE) foam and protected with a robust jacket. COOL-FIT 2.0 is the corrosion and condensation free solution for the transport of chilled water inside residential and commercial buildings as well as data centres and for process cooling. The smooth inner surface of the PE100 pipe provides a minimum pressure loss while the low thermal conductivity of the insulation ensures reduced energy loss and running costs for a life time. The 3-in-1 construction keeps installation time to a minimum.

50% faster installation

30% better energy efficiency

100% corrosion free

Take advantage of these benefits

+ Building owners

Minimised energy loss

Top quality insulation thickness and density throughout the entire system.

Light weight

Ideal for retrofitting of prestigious buildings.
30% less weight than traditional metal systems.

Hard external jacket

Vapour and moisture tight construction, mechanically loadable.

Low CO₂ footprint

CFC free and recyclable. Zero ODP.

+ General contractors and installers

Build more in less time

3-in-1: pipe, insulation and jacket in one step.

Reliable easy jointing

No hot works for the electrofusion jointing process.

Simple installation

The hard external jacket allows for simple, easy assembly with standard brackets.

Light weight and easy to handle

Up to d110 mm no need for lifts or special devices to handle on-site.

Off-site pre-fabrication

Reduced on-site labour time.

+ Planners and consultants

Easy and accurate planning

Planning fundamentals, CAD library, BIM compatible.

Complete compatible system – clearly defined interfaces

Insulated pipes, fittings, valves, clearly defined interfaces, flexible hoses – one system, one team, one producer.

A system for life

Corrosion and condensation free, moisture and vapour tight, low pressure loss and energy efficient.

State-of-the-art jointing technology

Machine controlled quality.

Application areas



Cooling system within the water cycle

Modern cities are constantly growing and changing. This increases the expectations of efficiency and performance of all types of devices. Their use raises enormous amounts of heat increasing the need for air conditioning.

Air conditioning also plays an important role in everyday life, as the ambient temperature affects people's well-being and productivity - whether at work or during leisure time, at home or traveling.

GF Piping Systems offers its unique and extensive COOL-FIT range for all types of cooling requirements.



1) Airport

2) Office building

3) Data centre

4) Hospital

5) Hotel

6) Apartment

7) Shopping centre

8) Sports / leisure centre

9) University

10) Bank / public institutions

Air conditioning

Comfort cooling

Apartments and office buildings, hotels, universities and schools, banks, shopping centres, airports, cinemas and theatres, sports and event facilities. Air conditioning improves the quality of life both at work, at home and at leisure venues.

The “ready-to-install” COOL-FIT 2.0 is a revolution for efficient cooling.

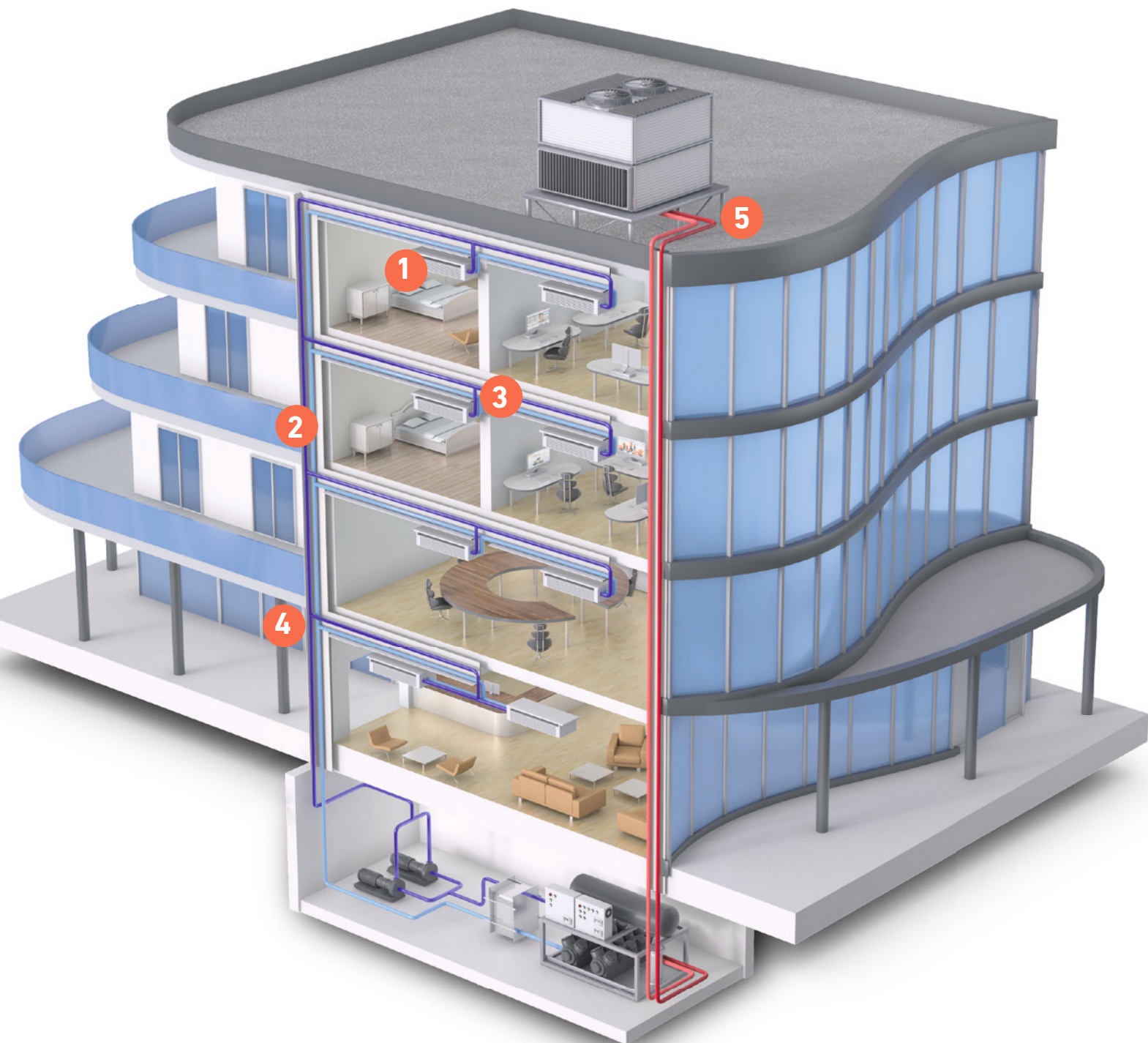



Connection to fan coils

Pre-fabricated insulated hoses to the transition union prevent corrosion.

- Insulated valves
- Pre-insulated hoses
- Pre-insulated transitions

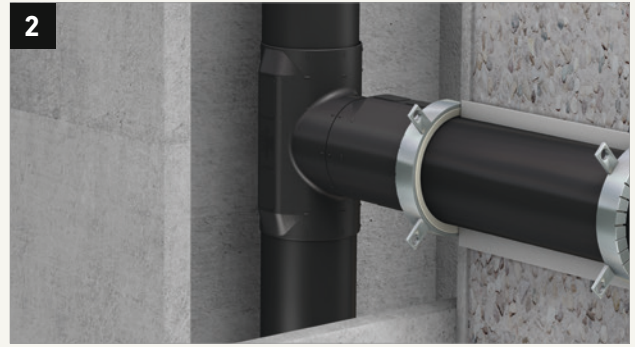

Risers

Post-insulation in vertical service channels is time-consuming and difficult.

- Pre-insulated pipes in large dimensions



Reduced branches

- Pre-insulated reduced tees
- Pre-insulated transition fittings: ecoFIT, iFIT, Sanipex MT and traditional metal systems

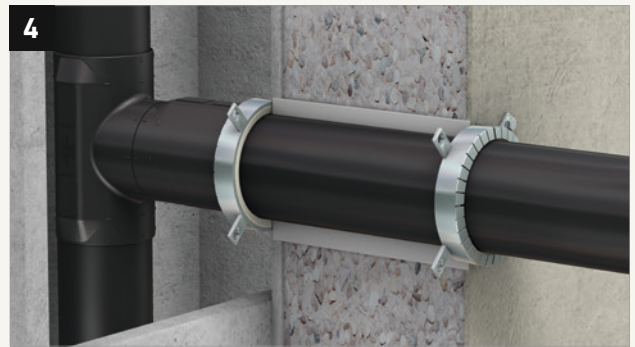

Fire wall penetrations

Safe pipe wall penetrations with tried and tested existing products.

- Proved and certified solution for COOL-FIT 2.0



d140 - d200, refer to COOL-FIT 4.0 system

Data centres

Safe cooling

On average, 70% of data centre power is converted into heat, as announced at the annual Green Data Center Conference*. COOL-FIT 2.0 is the safe piping solution for an effective and efficient design, supply, installation and management of the cooling systems of a data centre.

The “ready-to-install” COOL-FIT 2.0 is a revolution for efficient cooling.

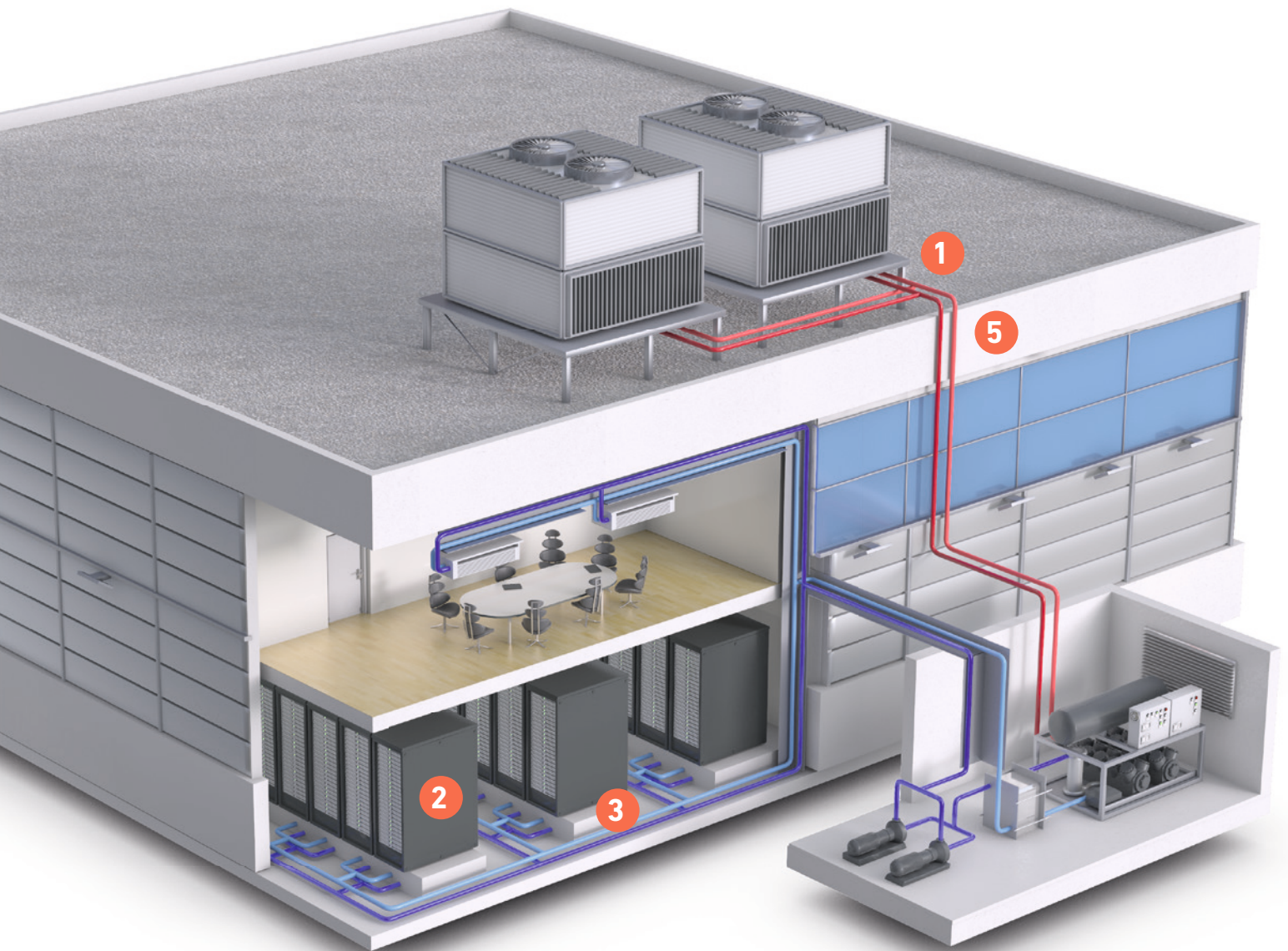

* Statement at the Green Data Center Conference, 2014.

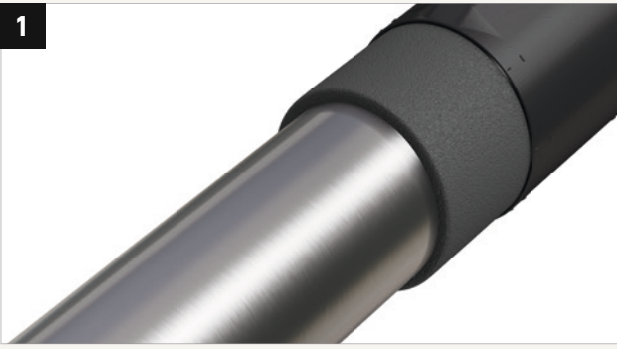

1 Connection to cooling towers

Many types of transitions enable the connection to adjoining systems including PE/Brass, PE/Stainless Steel and PE/ABS.

- Pre-insulated transitions to metal threaded systems and standard flanges



2 Rack cooling

Simple pre-insulated connection to all computer racks.

- Pre-insulated hoses provide simple connection to cooling back panels
- Pre-insulated valves for individual circuit control
- Pre-insulated transitions
- Machine guided welding process with traceability



3 Electrofusion

Helps to avoid installer errors.

- Machine controlled fusion process with traceability to ISO 13950



4 d140-d200mm, refer to COOL-FIT 4.0 system





System overview

More than a system

All COOL-FIT 2.0 items are pre-insulated. Products which need to be maintained, such as valves, are delivered with removable insulation.

COOL-FIT 2.0

		d25 mm	d32 mm	d40 mm	d50 mm	d63 mm	d75 mm	d90 mm	d110 mm	d140 mm
	Pipes PN16	–	●	●	●	●	●	●	●	●
	Couplers	–	●	●	●	●	●	●	●	●
	Elbows 90° / 45°	–	●	●	●	●	●	●	●	●
	T-90° equal	–	●	●	●	●	●	●	●	●
	T-90° reduced	–	–	●	●	●	●	●	●	●
	Reducers	–	–	●	●	●	●	●	●	●
	Flexible hoses	●	●	●	●	–	–	–	–	–
	Ball valves	–	●	●	●	●	●	●	–	–
	Butterfly valves	–	–	–	–	–	–	–	●	●
	Transition fittings	–	●	●	●	●	●	●	●	●
	Fixed points	–	●	●	●	●	●	●	●	●

Tools

	Tools	–	●	●	●	●	●	●	●	●
	Fusion machine	–	●	●	●	●	●	●	●	●

+ Compatible systems



ecoFIT PE100



iFIT

+ Chemical resistance to cooling agents

COOL-FIT 2.0 can be used with various types of cooling agents, such as:

- Water
- Organic salt solutions
- Inorganic salt solutions
- Water-Glycol mixtures up to 50%
- Ice slurry

Refer to the GF Planning Fundamentals for more detailed information.

Material properties

COOL-FIT 2.0

Materials*	Media pipe	PE100
	Insulation	GF HE foam, CFC free, closed cell
	Outer jacket	Pipe: HDPE, fitting: GF HE Foam
Dimensions		d32 - d140 (DN25 - DN125)
Joining technology		Electrofusion welding
Pressure rating		16 bar, SDR11
Insulation	Thermal conductivity λ at 20°C	≤ 0.022 W/mK
	Density	≥ 70 kg/m ³
	Foam cell size	max. \varnothing 0.5 mm
	Thickness (Nominal)	22 mm
Temperature	Medium	0° C to +60° C
Weight	Pipe d32	1.12 kg/m
	(without liquid) Pipe d140	8.71 kg/m
Environment	Resistance	Water and vapour-tight
	Ozone depleting potential	Zero
Standards	EN ISO 15494	Plastic piping systems for industrial applications - Metric series
	ISO 7	Threaded joints
	EN ISO 16135, EN ISO 16138	Industrial valves

* All three materials are permanently jointed to each other.

Pressure / temperature

Medium: water

Minimum design life-span: 25 years

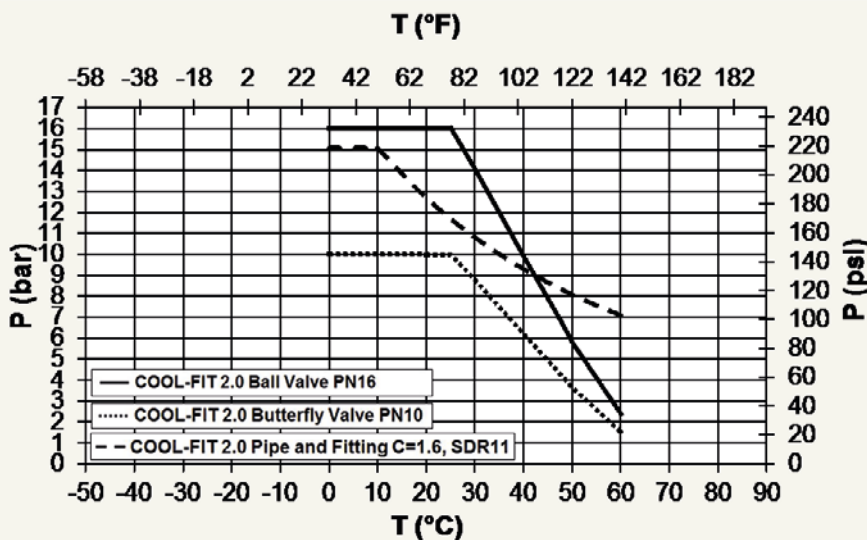

Remark: For water-glycol mixture $\leq 50\%$, the reduction factor for the pressure-temperature diagram is 1.1.

For PN 16, the security factor is 1.25.

P Medium pressure (bar, psi)
T Medium temperature (°C, °F)
C Safety factor

Planning fundamentals COOL-FIT 2.0

+ Definition of flexible sections COOL-FIT 2.0

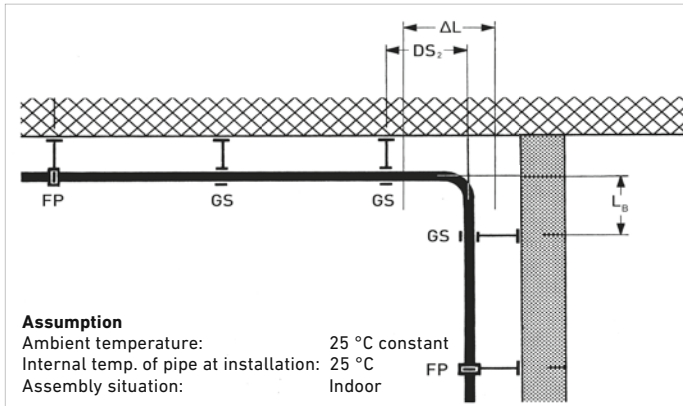

Expansion / contraction

The expansion and contraction of pipes is dependent on the cooling fluid temperature, the ambient temperature and the change of both temperatures in an application. It does not have a material expansion-/contraction factor as for standard pipes.

Use the COOL-FIT Calculation Tool to determine detailed, application specific values.

Length changes ΔL in [mm] at 20° C flow temp.

L [m]	25	50	100	150
d32 mm	-5	-10	-21	-31
d40 mm	-6	-12	-24	-36
d50 mm	-8	-16	-32	-48
d63 mm	-8	-17	-34	-51
d75 mm	-9	-18	-36	-54
d90 mm	-10	-20	-40	-59
d110 mm	-11	-22	-44	-66
d140 mm	-11	-23	-45	-68

Length changes ΔL in [mm] at 15° C flow temp.

L [m]	25	50	100	150
d32 mm	-11	-21	-42	-63
d40 mm	-12	-25	-49	-74
d50 mm	-16	-32	-65	-97
d63 mm	-17	-35	-69	-104
d75 mm	-18	-36	-73	-109
d90 mm	-20	-40	-80	-120
d110 mm	-22	-45	-90	-134
d140 mm	-23	-46	-91	-137

Length changes ΔL in [mm] at 10° C flow temp.

L [m]	25	50	100	150
d32 mm	-16	-32	-65	-97
d40 mm	-19	-38	-75	-113
d50 mm	-25	-49	-99	-148
d63 mm	-26	-53	-105	-158
d75 mm	-28	-55	-111	-166
d90 mm	-30	-61	-122	-183
d110 mm	-34	-68	-136	-203
d140 mm	-34	-69	-138	-207

Length changes ΔL in [mm] at 5° C flow temp.

L [m]	25	50	100	150
d32 mm	-22	-44	-88	-132
d40 mm	-26	-51	-102	-154
d50 mm	-33	-67	-133	-200
d63 mm	-36	-71	-142	-213
d75 mm	-37	-75	-149	-224
d90 mm	-41	-82	-164	-246
d110 mm	-46	-91	-182	-273
d140 mm	-46	-93	-185	-278

Flexible sections L_B in [cm]

ΔL [mm]	10	20	30	40	50	60	70	80	90	100	150	200	300
d32 / 75	71	101	123	142	159	174	188	201	214	225	276	318	390
d40 / 90	78	110	135	156	174	191	206	221	234	247	302	349	427
d50 / 90	78	110	135	156	174	191	206	221	234	247	302	349	427
d63 / 110	86	122	149	172	193	211	228	244	259	273	334	386	472
d75 / 125	92	130	159	184	206	225	243	260	276	291	356	411	503
d90 / 140	97	138	168	195	218	238	257	275	292	308	377	435	533
d110 / 160	104	147	180	208	233	255	275	294	312	329	403	465	570
d140 / 200	116	164	201	233	260	285	308	329	349	368	450	520	637

+ Pipe bracket distances

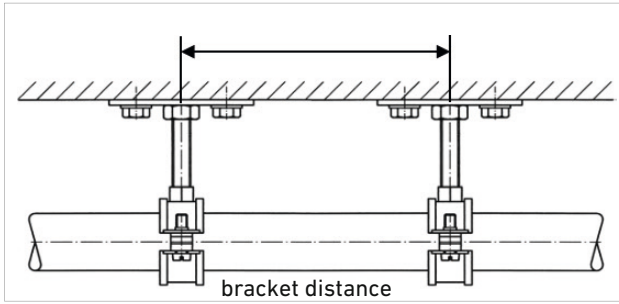

	d32	d40	d50	d63	d75	d90	d110	d140
Bracket distance (m) COOL-FIT 2.0	1.6	1.7	1.7	1.85	1.95	2.0	2.1	2.35

Values are valid independent of the ambient temperature.

+ COOL-FIT Calculation Tool

Dimension [mm / mm]	Durchfluss [m³/h]	Länge [m]
32 / 75	0	0
40 / 90	0	0
50 / 90	0	0
63 / 110	0	0
75 / 125	0	0
90 / 140	0	0
110 / 160	0	0
140 / 200	0	0

Dimension [mm / mm]	Geschwindigkeit [m/s]	ΔP [Bar]
32 / 75		
40 / 90		
50 / 90		
63 / 110		
75 / 125		
90 / 140		
110 / 160		
140 / 200		

Pipe system [-]	Total ΔP [Bar]
COOL-FIT 2.0	0
COOL-FIT 4.0	0
ecoFIT SDR11	0
ecoFIT SDR17	0
IFIT	0
SANPEX MT	0
TOTAL	0

The GF Piping Systems Cooling Calculation Tool is used to support in the dimensioning and design of cooling systems.

The Cooling Calculation Tool handles:

- Expansion, contraction
- Flexible section design
- Energy savings
- Pipe exterior temperature
- Pipe dimensioning
- Pressure loss
- Dew point / insulation thickness
- Pipe bracket spacing
- Freezing time
- Weight comparison
- CO₂ footprint

For COOL-FIT Calculation tool:

gfps.com/cooling-tools



NCC BCA COOL-FIT 2.0 R Values Energy Performance Solution Report

COOL-FIT 2.0* system meets the NCC BCA R value compliance on energy performance. To access the full report, visit www.gfps.com/au or contact our customer service team.

* COOL-FIT 2.0 d110/160 (DN100), please refer to GF Piping Systems Cooling Calculation Tool Software at www.gfps.com/au and letter of assessment of Calculation Tool Software for compliance on thermal performance issued on 23/02/2021.

COOL-FIT 2.0 is a pre-insulated plastic piping system designed for cooling applications.

The determination of thermal conductivity at the pre-insulated COOL-FIT pipes was carried out by the independent testing institute IMA (Materialforschung und Anwendungstechnik GmbH) in Dresden, Germany, following EN 15632-1, prEN 7414-1 and ISO 8497.

The calculation of areal thermal resistance R of the COOL-FIT pipe was performed according to ASTM C 335.

AS 1530.4 Fire Resistance Testing

FRL ratings available for all COOL-FIT 2.0 pipe d32 up to d140mm for concrete slab, plasterboard wall and speedpanel.

Testing and assessment conducted using Promat PROMASEAL FC100, FC150 and FC250 Retrofit and HILITI Retrofit collars.

Report Numbers: FAS190295, FRT190416 and FRT190417.

Visit www.gfps.com/au to access reports or contact our customer service team for more information.

We hereby confirm the following R-values (COOL-FIT 2.0 pipes):

Dimension d/D (mm)	R-Value (m ² .K/w)
32/75	1.4
40/90	1.6
50/90	1.2
63/110	1.3
75/125	1.4
90/140	1.3
110/160	1.3
140/200	1.3



The easy connection

The state-of-the-art electrofusion technology is perfect for on-site joining.

+ Electrofusion with GF Piping Systems

Electrofusion is a safe and reliable way to joint plastic piping systems. The installer only needs to connect the leads to the fitting, scan the bar code and leave the fusion process to the machine.

The electrofusion fittings are equipped with integrated resistance wires, which are supplied with electricity during the fusion process. Depending on the ambient temperature, the fusion time is automatically adjusted for the correct supply of energy. A soft start is applied to minimise the load on the power generator and fusion is carried out to completion. In case of anomalies, like inadequate input current or fitting wires fault, the machine stops immediately and informs the operator with a specific error message.



MSA electro fusion device

The MSA fusion devices can weld COOL-FIT 2.0 electrofusion fittings up to three times faster than welded steel joints. Risks to the surroundings caused by open flames simply do not exist. Fittings recognition through bar code scanning ensures the quality of the joint and due to recorded fusion parameters a high level of quality assurance is provided. Its low weight of less than 12 kg allows simple handling.



Foam removal tool

COOL-FIT 2.0 pipes are supplied with free ends (non-insulated), ready for assembling and fusion with fittings. If a pipe needs to be cut to the desired length, the foam removal tool helps to remove the foam and outer jacket dust-free and in less than two minutes. At the same time, it peels the surface of the media pipe in order to prepare it perfectly for the subsequent fusion process.

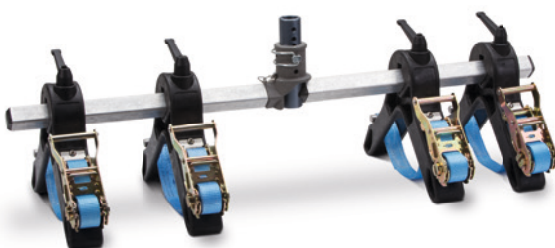

Pipe installation clamps

During the fusion process forces occur, causing the pipe to move out of the fitting. GF recommends to fix the assembly with COOL-FIT 2.0 installation clamps. They restrain the movement of the pipes and keep their alignment. Their reduced weights (less than 6kg) as well as their compact design allow easy overhead assemblies, even in narrow conditions.

Installation

Insert – Clamp – Weld – Done!



1 The GF foam removal tool helps to remove the foam and peel the pipe efficiently.



2 Clean pipe and fitting, then simply push pipe and fitting together.

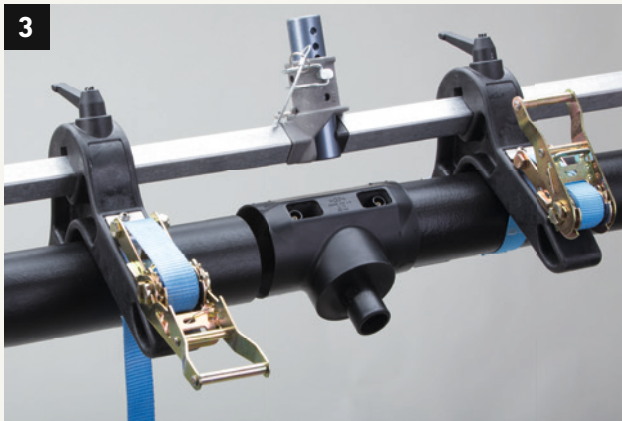

3 Use the pipe installation clamps in order to avoid tensions during installation.

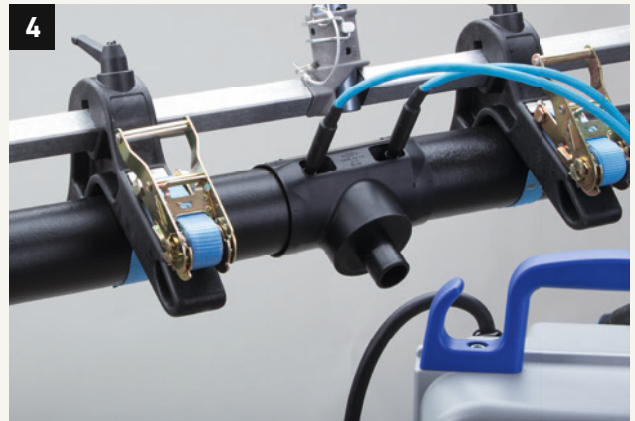

4 MSA welding devices ensure high quality jointings.



5 Check the system with a pressure test.



6 Seal the welding connectors with the attached insulation plugs - done!

The jointing of COOL-FIT 2.0 pipes, fittings and valves is very easy. The procedure takes just a few minutes and the GF Piping Systems MSA fusion devices ensure the quality of the joints.

For more information:
www.gfps.com/au



Environmental efficiency

The use of COOL-FIT 2.0 has significant advantages compared to traditional post-insulated metal systems, particularly when it comes to CO₂ emissions or energy loss.

+ CO₂ emissions

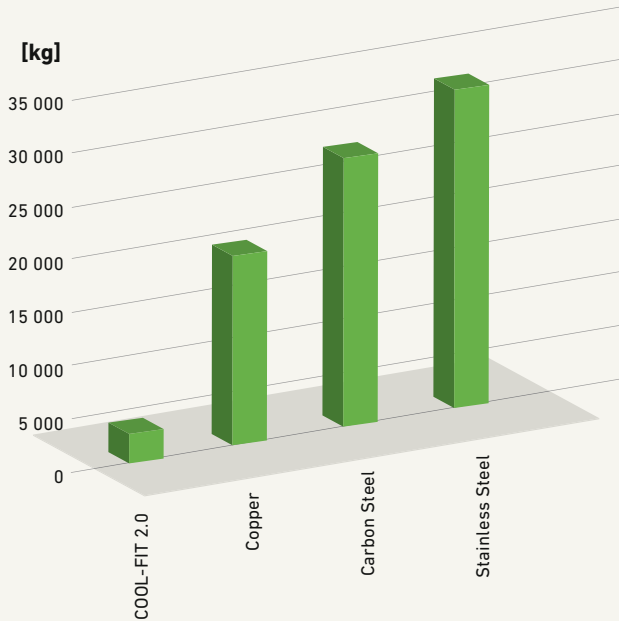

A three story building with e.g. 123 offices would need a piping system of nearly 3000 metres for chilled water for the air conditioning.

The use of copper for the piping system equates to 17.5 tonnes of CO₂ equivalent, which would be reduced to nearly 5 tonnes by using COOL-FIT 2.0. This saving is equivalent to a 78,000 km journey with an average car.



12.5 tonnes
CO₂ saved

Analyzing the energy loss on this same installation, COOL-FIT 2.0 is on average 35% more efficient compared to metal piping systems post-insulated with rubber based foam.

+ Total energy loss

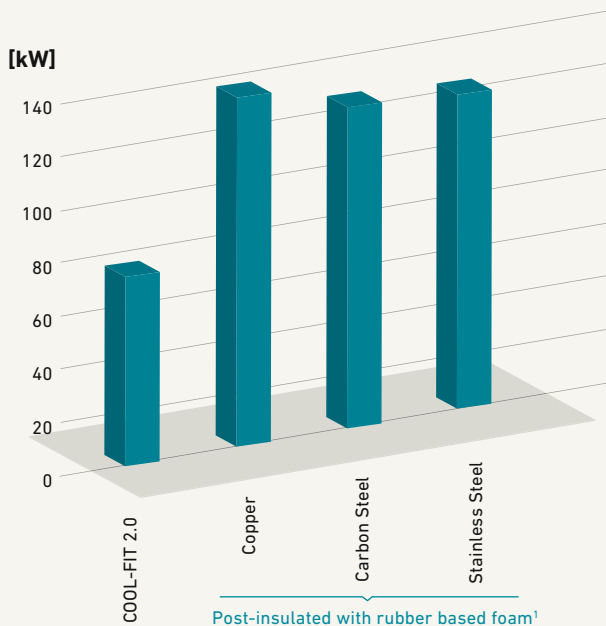

¹ "Life Cycle Analysis", conducted by the company ESU-services GmbH, Uster/ Switzerland (www.esu-services.ch) on behalf of Georg Fischer Piping Systems in 2008. Report available on www.gfps.com (Pioneering Green Solutions, GF Piping Systems)

#9 overall ranking in the 4th Quarter of 2020 for Wall Streets Journals update of the world's most sustainably managed companies.



The best choice for you

Corrosion and chemical resistant system solutions

+ Georg Fischer

Georg Fischer focuses on three core businesses: GF Piping Systems, GF Automotive and GF Machining Solutions. The industrial corporation, founded in 1802, headquarters in Switzerland and operates approximately 136 companies with more than 15,800 employees in 34 countries. GF Piping Systems is a leading supplier of plastic and metal piping systems with global market presence. We offer pipes, fittings, valves, automation products, jointing technology and corresponding services for the treatment of water and chemicals, as well as for the safe distribution of liquids and gases.

+ Our market segments

Being a strong implementation partner, GF Piping Systems supports its customers in every phase of the project. No matter which processes and applications are planned in the following market segments:

- Automation
- Building Technology
- Chemical Process Industry
- Energy
- Food & Beverage / Cooling
- Microelectronics
- Marine
- Water & Gas Utilities
- Water Treatment

+ Global presence

Our global presence ensures customer proximity worldwide. Sales companies in 26 countries and representatives in another 80 countries provide customer service around the clock. With 32 production sites in Europe, Asia and the USA, we are close to our customers and comply with local standards. A modern logistics concept with local distribution centres ensures highest product availability and short delivery times. GF Piping Systems' specialists are always close by.

+ Complete solutions provider

Our extensive product range represents a unique form of product and competence bundling. With over 70,000 products, allied with a broad range of services, we offer individual and comprehensive system solutions for a variety of industrial applications. Having the profitability of the projects of our customers in focus, we optimise processes and applications that are integrated into the whole system. Continually setting standards in the market, we directly provide our customers with technological advantages. Due to our worldwide network, customers benefit directly from our 50 years experience in plastics. From start to finish, we support our customers as a competent, reliable and experienced partner.

Adapting our business, to improve yours.

Pre-Fabrication & Customisation

GF Piping Systems can offer you support throughout your project, helping you bring your ideas and concepts to life. Take advantage of our experts and their extensive range of specialised plastic fabrication equipment for customised solutions, tailor made for your specifications. We combined our global footprint with more than 50+ years' of experience working with thermoplastic products, with our local knowledge of the market and our customers' needs to meet their requirements.

Fabrication Capabilities

- Fabricated Tees and Sweep Bends up to 800 mm
- Butt Welding: 63 mm – 800 mm
- Electrofusion Welding: 20mm – 1,200 mm
- Saddle Welding
- System Assembly
- Spool and Header Manufacturing
- Extrusion Welding
- Rooftop Water Distribution Modules
- High Point Vents (HPV) and Low Point Drains (LPD) for Coal Seam Gas
- Hydrostatic Pressure Testing
- Signet Assemblies Remote Devices
- Many more ...

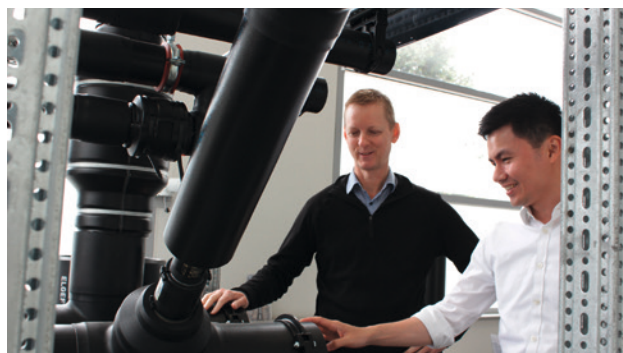
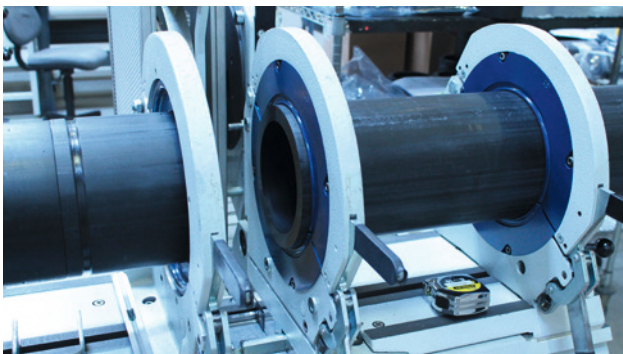

COOL-FIT 2.0

Product range



COOL-FIT 2.0 Pipes

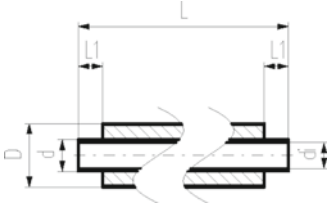

COOL-FIT 2.0 Pipe

Model:

- Pre-insulated PE100 SDR11, metric
- Insulation made from GF HE foam
- Impact resistant. Colour: black
- With free ends for electrofusion

Note:

Bigger dimensions available via COOL-FIT 4.0 product range

d/D (mm)	DN (mm)	PN (bar)	Code GF	Code Reece	Weight (kg/m)	di (mm)	L (mm)	L1 (mm)	Closest Inch (inch)
32/75	25	16	738 174 108	1470096	1.140	26.2	5000	36	1
40/90	32	16	738 174 109	1470097	1.534	32.6	5000	40	1 ¼
50/90	40	16	738 174 110	1470098	1.722	40.8	5000	44	1 ½
63/110	50	16	738 174 111	1470099	2.711	51.4	5000	48	2
75/125	65	16	738 174 112	1470100	3.405	61.4	5000	55	2 ½
90/140	80	16	738 174 113	1470101	4.320	73.5	5000	62	3
110/160	100	16	738 174 114	1470102	5.692	90.0	5000	72	4
140/200	125	16	738 174 116	1470103	9.021	114.6	5000	84	5

COOL-FIT 2.0 Fittings

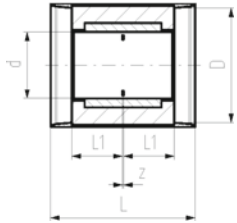

COOL-FIT 2.0 Coupler

Model:

- Pre-insulated PE100 SDR11, metric
- Insulation made from GF HE foam
- Impact resistant. Colour: black
- Integrated sealing lip, for a moisture-proof and vapour tight sealing

Note:

Bigger dimensions available via COOL-FIT 4.0 product range

d/D (mm)	PN (bar)	Code GF	Code Reece	Weight (kg/m)	L (mm)	L1 (mm)	z (mm)	Closest Inch (inch)
32/75	16	738 914 108	1470214	0.092	113	36	5	1
40/90	16	738 914 109	1470215	0.126	121	40	3	1 ¼
50/90	16	738 914 110	1470216	0.160	129	44	3	1 ½
63/110	16	738 914 111	1470217	0.237	137	48	3	2
75/125	16	738 914 112	1470218	0.339	152	55	3	2 ½
90/140	16	738 914 113	1470219	0.476	166	62	4	3
110/160	16	738 914 114	1470220	0.778	188	72	4	4
140/200	16	738 914 116	1470221	1.097	210	84	3	5



A



B

COOL-FIT 2.0 Elbow 90°

Model:

- Pre-insulated PE100 SDR11, metric
- Insulation made from GF HE foam
- Impact resistant. Colour: black
- A: Electrofusion Fitting with integrated sealing lip, for a moisture-proof and vapour tight sealing
- B: Spigot Fitting with free end (separate electrofusion fitting needed for joining)

d/D (mm)	PN (bar)	Code GF	Code Reece	Weight (kg)	L (mm)	L1 (mm)	z (mm)	Closest Inch (inch)	Type
32/75	16	738 104 108	1470073	0.127	75	36	20	1	A
40/90	16	738 104 109	1470074	0.185	82	40	23	1 ¼	A
50/90	16	738 104 110	1470075	0.242	93	44	30	1 ½	A
63/110	16	738 104 111	1470076	0.384	101	48	34	2	A
75/125	16	738 104 112	1470077	0.510	114	55	40	2 ½	A
90/140	16	738 104 113	1470078	0.960	144	62	63	3	A
110/160	16	738 104 114	1470079	1.406	168	72	77	4	A
140/200	16	738 104 116	1470080	2.690	-	84	221	5	B

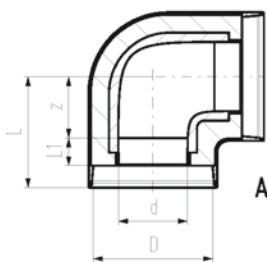

A

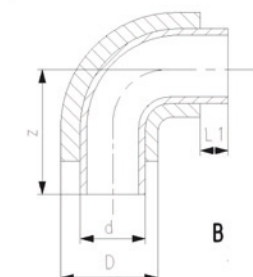

B

COOL-FIT 2.0 Elbow 45°

Model:

- Pre-insulated PE100 SDR11, metric
- Insulation made from GF HE foam
- Impact resistant. Colour: black
- A: Electrofusion Fitting with integrated sealing lip, for a moisture-proof and vapour tight sealing
- B: Spigot Fitting with free end (separate electrofusion fitting needed for joining)



A



B

d/D (mm)	PN (bar)	Code GF	Code Reece	Weight (kg)	L (mm)	L1 (mm)	z (mm)	Closest Inch (inch)	Type
32/75	16	738 154 108	1470088	0.101	66	36	11	1	A
40/90	16	738 154 109	1470089	0.143	70	40	11	1 ¼	A
50/90	16	738 154 110	1470090	0.206	76	44	13	1 ½	A
63/110	16	738 154 111	1470091	0.307	83	48	16	2	A
75/125	16	738 154 112	1470092	0.407	92	55	18	2 ½	A
90/140	16	738 154 113	1470093	0.686	111	62	30	3	A
110/160	16	738 154 114	1470094	1.123	132	72	41	4	A
140/200	16	738 154 116	1470095	1.967	-	84	164	5	B

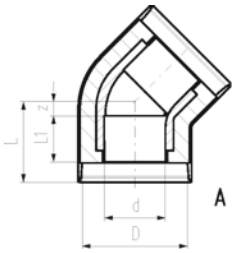

A

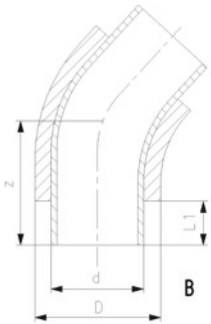

B

COOL-FIT 2.0 Tee 90° equal

Model:

- Pre-insulated PE100 SDR11, metric
- Insulation made from GF HE foam
- Impact resistant. Colour: black
- A: Electrofusion Fitting with integrated sealing lip, for a moisture-proof and vapour tight sealing
- B: Spigot Fitting with free end (separate electrofusion fitting needed for joining)



A



B

d/D (mm)	PN (bar)	Code GF	Code Reece	Weight (kg)	L (mm)	L1 (mm)	z (mm)	z1 (mm)	Closest Inch (inch)	Type
32/75	16	738 204 108	1470111	0.154	73	36	18	98	1	A
40/90	16	738 204 109	1470112	0.230	81	40	22	112	1 ¼	A
50/90	16	738 204 110	1470113	0.306	88	44	25	125	1 ½	A
63/110	16	738 204 111	1470114	0.492	97	48	30	147	2	A
75/125	16	738 204 112	1470115	0.673	110	55	36	140	2 ½	A
90/140	16	738 204 113	1470116	1.022	124	62	43	161	3	A
110/160	16	738 204 114	1470117	1.751	148	72	57	184	4	A
140/200	16	738 204 116	1470118	3.317	-	84	198	193	5	B

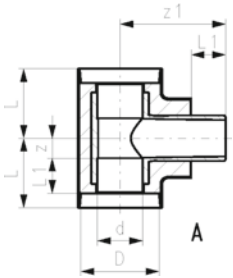

A

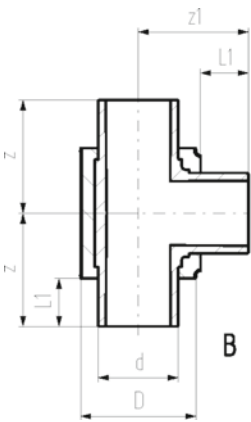

B

COOL-FIT 2.0 Tee 90° reduced

Model:

- Pre-insulated PE100 SDR11, metric
- Insulation made from GF HE foam
- Impact resistant. Colour: black
- A: Electrofusion Fitting with integrated sealing lip, for a moisture-proof and vapour tight sealing. Branch with free pipe end.
- B: Spigot Fitting with free end (separate electrofusion fitting needed for joining)



A



B

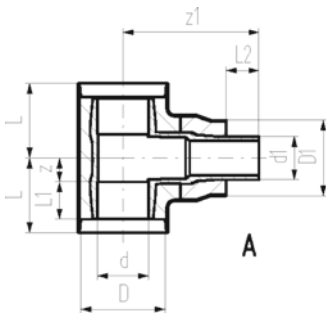

A

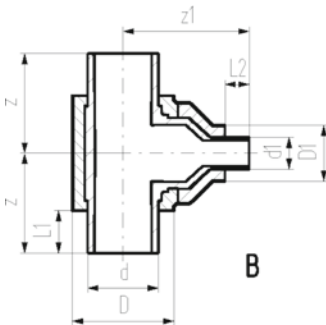

B

d/D (mm)	d1/D1 (mm)	PN (bar)	Code GF	Code Reece	Weight (kg)	L (mm)	L1 (mm)	L2 (mm)	z (mm)	z1 (mm)	Closest Inch (inch)	Type
75/125	63/110	16	738 204 218	1470119	0.746	110	55	48	36	200	2 ½ - 2	A
90/140	63/110	16	738 204 222	1470120	1.096	124	62	48	42	227	3 - 2	A
90/140	75/125	16	738 204 223	1470121	1.133	124	62	55	42	227	3 - 2 ½	A
110/160	63/110	16	738 204 227	1470122	1.746	148	72	48	57	245	4 - 2	A
110/160	75/125	16	738 204 228	1470123	1.782	148	72	55	57	245	4 - 2 ½	A
110/160	90/140	16	738 204 229	1470124	1.848	148	72	62	57	245	4 - 3	A
140/200	63/110	16	738 204 340	1470125	3.441	-	84	48	198	250	5 - 2	B
140/200	75/125	16	738 204 341	1470126	3.504	-	84	55	198	262	5 - 2 ½	B
140/200	90/140	16	738 204 342	1470127	3.569	-	84	62	198	263	5 - 3	B
140/200	110/160	16	738 204 343	1470128	3.620	-	84	72	198	258	5 - 4	B



COOL-FIT 2.0 Tee 90° reduced, short

Model:

- Pre-insulated PE100 SDR11, metric
- Insulation made from GF HE foam
- Impact resistant. Colour: black
- A: Electrofusion Fitting with integrated sealing lip, for a water and vapour tight sealing
- Space-optimised branch: sealing lip of Fitting Type A that joins to the branch, needs to be cut and adhesive ring be used

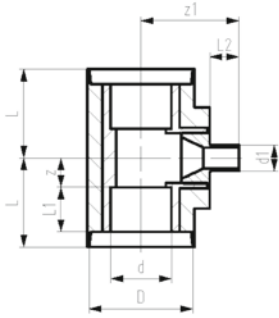

d/D (mm)	d1 (mm)	PN (bar)	Code GF	Code Reece	L (mm)	L1 (mm)	L2 (mm)	z (mm)	z1 (mm)	Closest Inch (inch)	Type
40/90	32	16	738 204 506	1470583	81	40	36	22	108	1 ¼ - 1	A
50/90	32	16	738 204 509	1470584	88	44	36	25	117	1 ½ - 1	A
63/110	32	16	738 204 512	1470585	97	48	36	30	135	2 - 1	A
75/125	32	16	738 204 515	1470586	110	55	36	36	121	2 ½ - 1	A
90/140	32	16	738 204 519	1470587	124	62	36	43	135	3 - 1	A
110/160	32	16	738 204 524	1470588	148	72	36	57	148	4 - 1	A

COOL-FIT 2.0 Reducer

Model:

- Pre-insulated PE100 SDR11, metric
- Insulation made from GF HE foam
- Impact resistant. Colour: black
- A: Electrofusion Fitting with integrated sealing lip, for a moisture-proof and vapour tight sealing
- B: Spigot Fitting with free end (separate electrofusion fitting needed for joining)

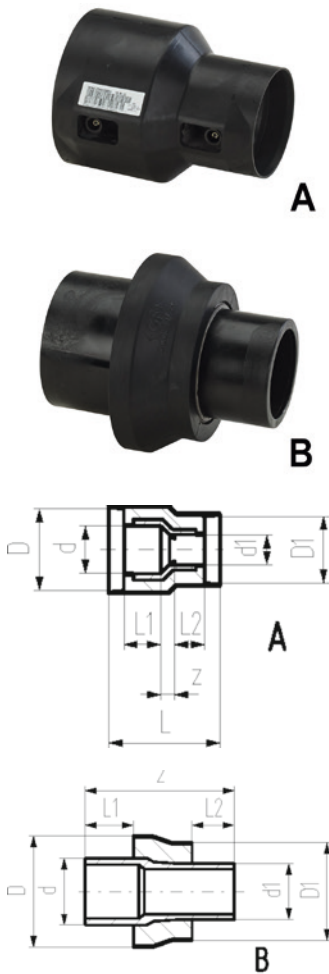

d/D (mm)	d1/D1 (mm)	PN (bar)	GF Code	Reece Code	Weight (kg)	L (mm)	L1 (mm)	L2 (mm)	z (mm)	Closest Inch (inch)	Type
40/90	32/75	16	738 904 206	1470181	0.125	131	40	36	17	1 ¼ - 1	A
50/90	32/75	16	738 904 209	1470182	0.154	139	44	36	21	1 ½ - 1	A
50/90	40/90	16	738 904 210	1470183	0.153	137	44	40	15	1 ½ - 1 ¼	A
63/110	32/75	16	738 904 212	1470184	0.198	148	48	36	26	2 - 1	A
63/110	40/90	16	738 904 213	1470185	0.221	147	48	40	21	2 - 1 ¼	A
63/110	50/90	16	738 904 214	1470186	0.219	147	48	44	17	2 - 1 ½	A
90/140	63/110	16	738 904 222	1470187	0.464	187	62	48	39	3 - 2	A
110/160	90/140	16	738 904 229	1470188	0.799	214	72	62	42	4 - 3	A
75/125	63/110	16	738 904 318	1470189	0.244	-	55	48	170	2 ½ - 2	B
90/140	63/110	16	738 904 322	1470190	0.360	-	62	48	190	3 - 2	B
90/140	75/125	16	738 904 323	1470191	0.395	-	62	55	190	3 - 2 ½	B
110/160	63/110	16	738 904 327	1470192	0.523	-	72	48	205	4 - 2	B
110/160	75/125	16	738 904 328	1470193	0.553	-	72	55	205	4 - 2 ½	B
110/160	90/140	16	738 904 329	1470194	0.599	-	84	62	205	4 - 3	B
140/200	63/110	16	738 904 340	1470195	0.917	-	84	48	225	5 - 2	B
140/200	75/125	16	738 904 341	1470196	0.997	-	84	55	237	5 - 2 ½	B
140/200	90/140	16	738 904 342	1470197	1.039	-	84	62	238	5 - 3	B
140/200	110/160	16	738 904 343	1470198	1.051	-	84	72	233	5 - 4	B



COOL-FIT 2.0 Reducer, short

Model:

- Spigot fitting PE100 SDR11, metric with free end
- Space-optimised branch: sealing lip of Fitting Type A that joins to the branch, needs to be cut and adhesive ring be used

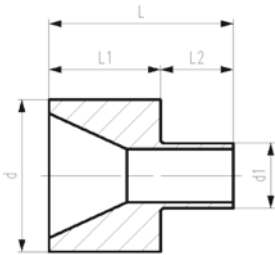

d (mm)	d1 (mm)	PN (bar)	Code GF	Code Reece	L (mm)	L1 (mm)	L2 (mm)
40	32	16	738 900 506	1470589	76	40	36
50	32	16	738 900 509	1470590	80	44	36
50	40	16	738 900 510	1470591	84	44	40
63	32	16	738 900 512	1470592	84	48	36
63	40	16	738 900 513	1470593	88	48	40
63	50	16	738 900 514	1470594	92	48	44
75	32	16	738 900 515	1470595	91	55	36
90	32	16	738 900 519	1470596	98	62	36
110	32	16	738 900 524	1470597	108	72	36



COOL-FIT 2.0 Installation fitting type 313

Model:

- Pre-insulated PE100 SDR11, metric
- Insulation made from GF HE foam
- Impact resistant. Colour: black
- With threaded branch for sensors (i.e temperature, pressure)
- A: Electrofusion Fitting with integrated sealing lip, for a moisture-proof and vapour tight sealing
- B: Spigot Fitting with free end (separate electrofusion fitting needed for joining)

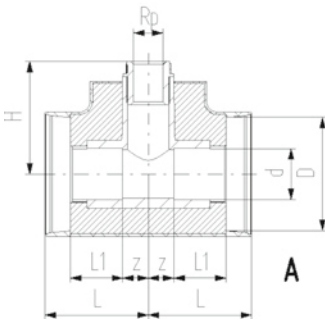

d/D (mm)	Rp (inch)	PN (bar)	Code GF	Code Reece	Weight (kg)	L (mm)	L1 (mm)	z (mm)	H (mm)	Closest Inch (inch)	Type
32/75	1/2	16	738 313 408	1470136	0.138	73	36	16	75	1	A
40/90	1/2	16	738 313 409	1470137	0.216	81	40	21	85	1 1/4	A
40/90	3/4	16	738 313 459	1470144	0.216	81	40	21	88	1 1/4	A
50/90	1/2	16	738 313 410	1470138	0.308	88	44	24	94	1 1/2	A
50/90	3/4	16	738 313 460	1470145	0.307	88	44	24	97	1 1/2	A
63/110	1/2	16	738 313 411	1470139	0.493	97	48	29	113	2	A
63/110	3/4	16	738 313 461	1470146	0.492	97	48	29	116	2	A
75/125	1/2	16	738 313 412	1470140	0.687	110	55	35	99	2 1/2	A
75/125	3/4	16	738 313 462	1470147	0.677	110	55	35	102	2 1/2	A
90/140	1/2	16	738 313 413	1470141	1.025	123	62	42	113	3	A
90/140	3/4	16	738 313 463	1470148	1.023	123	62	42	116	3	A
110/160	1/2	16	738 313 414	1470142	1.765	148	72	56	128	4	A
110/160	3/4	16	738 313 464	1470149	1.763	148	72	56	131	4	A
140/200	1/2	16	738 313 416	1470143	3.406	224	84	447	110	5	B
140/200	3/4	16	738 313 466	1470150	3.401	224	84	447	113	5	B

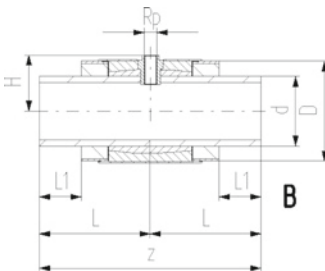

COOL-FIT 2.0 Transition Fittings



A



B

COOL-FIT 2.0 Transition Tee90°, PE/Brass with female thread Rp

Model:

- Pre-insulated, PE100, SDR11, metric
- Brass CW617N with female thread Rp
- Insulation made from GF HE foam
- Impact resistant. Colour: black
- A: Electrofusion Fitting with integrated sealing lip, for a water and vapour tight sealing
- B: Spigot Fitting with free end (separate electrofusion fitting needed for joining)

d (mm)	Rp (inch)	PN (bar)	Code GF	Code Reece	L (mm)	L1 (mm)	z (mm)	H (mm)	Closest Inch (inch)	Type
63/110	2	16	738 954 061	1470657	97	48	29	212	2	A
75/125	2	16	738 954 062	1470658	110	55	36	193	2½	A
90/140	2	16	738 954 063	1470659	124	62	43	210	3	A
110/160	2	16	738 954 064	1470660	148	72	57	223	4	A
140/200	2	16	738 954 066	1470661	-	84	447	316	5	B

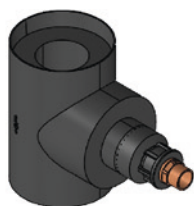
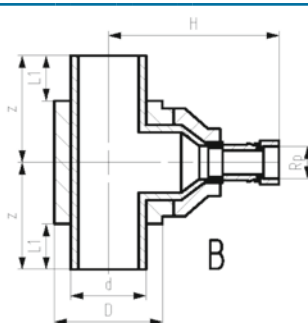
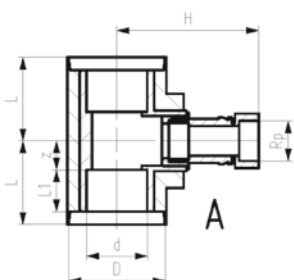

COOL-FIT 2.0 Transition T90° PE/Brass with male thread Rp

Model:

- Pre-insulated, PE100, SDR11, metric
- Brass CW617N with male thread BSP
- Insulation made from GF HE foam
- Impact resistant. Colour: black
- A: Electrofusion Fitting with integrated sealing lip, for water and vapour type sealing

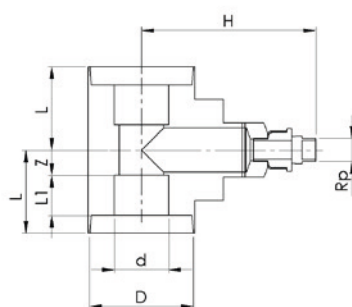

d (mm)	Rp (inch)	PN (bar)	Code GF	Code Reece	L (mm)	L1 (mm)	z (mm)	H (mm)	Closest Inch (inch)	Type
32/75	1	16	20006A463	1470690	73	36	18	192	1	A
40/90	1	16	20006A464	1470691	81	40	22	216	1 1/4	A
50/90	1	16	20006A465	1470692	88	40	25	214	1 1/2	A
63/110	3/4	16	20006A448	1470682	97	48	30	235	2	A
63/110	1	16	20006A449	1470683	97	48	30	235	2	A
75/125	3/4	16	20006A450	1470684	110	55	36	222	2 1/2	A
75/124	1	16	20006A451	1470685	110	55	36	222	2 1/2	A
90/125	1	16	20006A466	1470693	124	62	43	238	3	A
110/160	1	16	20006A467	1470694	148	72	57	253	4	A
140/200	1	16	-	-	-	-	-	-	5	B

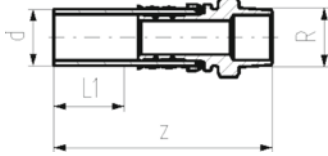

COOL-FIT 2.0 Adaptor fitting PE/stainless steel with male thread R

Model:

- Spigot fitting PE100 SDR11, metric with free end
- Stainless steel 1.4404 / 316L with male thread R
- Gasket: O-ring EPDM
- Including Insulation made from NBR foam

d (mm)	R (inch)	PN (bar)	Code GF	Code Reece	Weight (kg)	D (mm)	L1 (mm)	z (mm)
32	1/2	16	738 944 508	1470251	0.194	70	36	130
32	3/4	16	738 944 518	1470255	0.202	70	36	134
32	1	16	738 944 528	1470256	0.211	70	36	134
40	1 1/4	16	738 944 509	1470252	0.595	78	40	156
50	1 1/2	16	738 944 510	1470253	0.954	88	44	168
63	2	16	738 944 511	1470254	1.381	101	48	179

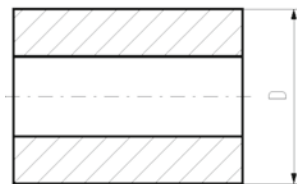
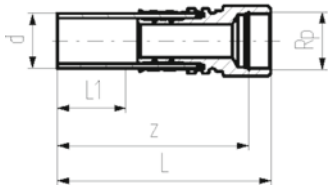

COOL-FIT 2.0 Adaptor fitting PE/stainless steel with female thread Rp

Model:

- Spigot fitting PE100 SDR11, metric with free end
- Stainless steel 1.4404 / 316L with femal thread Rp
- Gasket: O-ring EPDM
- Including Insulation made from NBR foam

d (mm)	Rp (inch)	PN (bar)	Code GF	Code Reece	Weight (kg)	D (mm)	L (mm)	L1 (mm)	z (mm)
32	1/2	16	738 944 008	1470233	0.201	70	132	36	118
32	3/4	16	738 944 018	1470237	0.226	70	132	36	116
32	1	16	738 944 028	1470238	0.251	70	132	36	115
40	1 1/4	16	738 944 009	1470234	0.626	78	157	40	141
50	1 1/2	16	738 944 010	1470235	0.670	88	150	44	128
63	2	16	738 944 011	1470236	1.170	101	164	48	140



COOL-FIT 2.0 Adaptor fitting PE/stainless steel with loose union nut G

Model:

- Spigot fitting PE100 SDR11, metric with free end
- Stainless steel 1.4404 / 316L with female thread G
- Including flat seal EPDM
- Including Insulation made from NBR foam

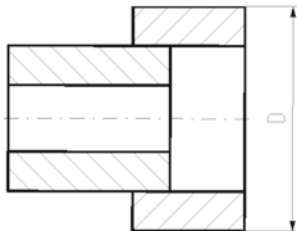
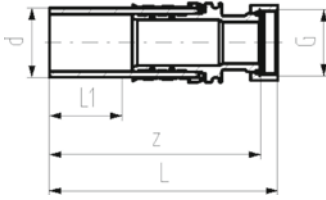

d (mm)	G (inch)	PN (bar)	Code GF	Code Reece	Weight (kg)	D (mm)	L (mm)	L1 (mm)	z (mm)
32	1/2	16	738 944 308	-	0.204	70	135	36	126
32	3/4	16	738 944 318	-	0.219	70	135	36	129
32	1	16	738 944 328	1470245	0.317	70	135	36	129
32	1 1/4	16	738 944 338	1470249	0.317	108	137	36	131
40	1 1/4	16	738 944 309	1470239	0.538	78	155	40	148
40	1 1/2	16	738 944 319	1470242	0.615	116	157	40	148
40	2	16	738 944 329	1470246	0.815	116	166	40	150
50	1 1/2	16	738 944 310	1470240	0.758	88	164	44	154
50	1 3/4	16	738 944 320	1470243	0.827	88	164	44	155
50	2	16	738 944 330	1470247	1.048	126	178	44	162
50	2 1/4	16	738 944 340	1470250	0.866	126	148	44	134
63	2	16	738 944 311	1470241	1.237	101	186	48	170
63	2 3/8	16	738 944 321	1470244	1.344	139	178	48	168
63	2 3/4	16	738 944 331	1470248	1.230	139	157	48	141

COOL-FIT 2.0 Adaptor fitting PE/Brass with male thread R

Model:

- Spigot fitting PE100 SDR11, metric with free end
- Brass CW617N with male thread R
- Gasket: O-ring EPDM
- Including Insulation made from NBR foam

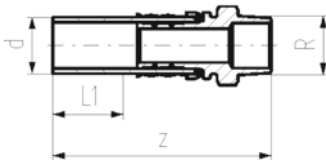

d (mm)	Rp (inch)	PN (bar)	Code GF	Code Reece	Weight (kg)	D (mm)	L1 (mm)	z (mm)
32	1/2	16	738 954 508	1470275	0.203	70	36	130
32	3/4	16	738 954 518	1470279	0.211	70	36	134
32	1	16	738 954 528	1470280	0.221	70	36	134
40	1 1/4	16	738 954 509	1470276	0.631	78	40	156
50	1 1/2	16	738 954 510	1470277	1.013	88	44	168
63	2	16	738 954 511	1470278	1.467	101	48	179



COOL-FIT 2.0 Adaptor fitting PE/Brass with female thread Rp

Model:

- Spigot fitting PE100 SDR11, metric with free end
- Brass CW617N with female thread Rp
- Gasket: O-ring EPDM
- Including Insulation made from NBR foam

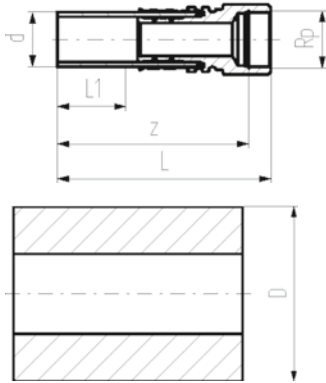

d (mm)	Rp (inch)	PN (bar)	Code GF	Code Reece	Weight (kg)	D (mm)	L (mm)	L1 (mm)	z (mm)
32	1/2	16	738 954 008	1470257	0.210	70	132	36	118
32	3/4	16	738 954 018	1470261	0.237	70	132	36	116
32	1	16	738 954 028	1470262	0.264	70	132	36	115
40	1 1/4	16	738 954 009	1470258	0.667	78	157	40	141
50	1 1/2	16	738 954 010	1470259	0.713	88	150	44	128
63	2	16	738 954 011	1470260	1.246	101	164	48	140



COOL-FIT 2.0 Adaptor fitting PE/Brass with loose union nut G

Model:

- Spigot fitting PE100 SDR11, metric with free end
- Brass CW617N with female thread G
- Including flat seal EPDM
- Including Insulation made from NBR foam

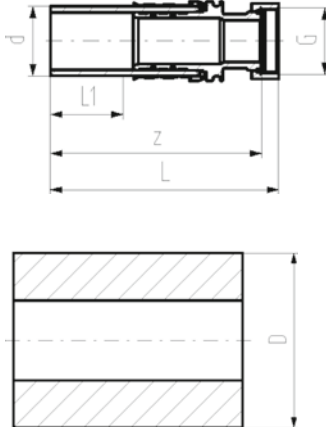

d (mm)	G (inch)	PN (bar)	Code GF	Code Reece	Weight (kg)	D (mm)	L (mm)	L1 (mm)	z (mm)
32	3/4	16	738 954 318	-	0.224	70	135	36	126
32	1	16	738 954 328	1470269	0.263	70	135	36	129
32	1 1/4	16	738 954 338	1470273	0.335	108	137	36	129
40	1 1/4	16	738 954 309	1470263	0.569	78	155	40	148
40	1 1/2	16	738 954 319	1470266	0.650	116	157	40	148
40	2	16	738 954 329	1470270	0.864	116	166	40	150
50	1 1/2	16	738 954 310	1470264	0.801	88	164	44	154
50	1 3/4	16	738 954 320	1470267	0.874	88	164	44	155
50	2	16	738 954 330	1470271	1.111	126	178	44	162
50	2 1/4	16	738 954 340	1470274	0.915	126	148	44	134
63	2	16	738 954 311	1470265	1.310	101	186	48	170
63	2 3/8	16	738 954 321	1470268	1.422	139	178	48	168
63	2 3/4	16	738 954 331	1470272	1.300	139	157	48	141

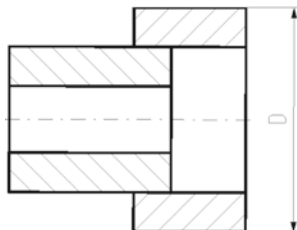



COOL-FIT 2.0 Adaptor Union PE/Stainless steel with male thread R

Model:

- Union bush: Spigot fitting PE100 SDR11, metric with free end
- Union End: Stainless steel 1.4404 / 316L with male thread R
- Gasket: O-ring EPDM No. 748 410 008-011
- Union Nut: PEGF25
- Including Insulation made from NBR foam

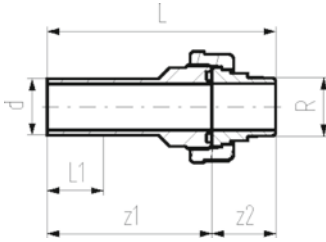

d (mm)	R (inch)	PN (bar)	Code GF	Code Reece	Weight (kg)	D (mm)	L (mm)	L1 (mm)	z1 (mm)	z2 (mm)
32	1	16	738 544 708	1470169	0.310	108	147	36	107	40
40	1 ¼	16	738 544 709	1470170	0.538	116	163	40	117	46
50	1 ½	16	738 544 710	1470171	0.660	126	172	44	124	48
63	2	16	738 544 711	1470172	1.073	139	191	48	136	55

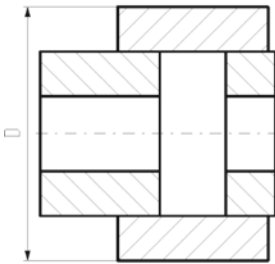

COOL-FIT 2.0 Adaptor Union PE/Stainless steel with female thread Rp

Model:

- Union bush: Spigot fitting PE100 SDR11, metric with free end
- Union End: Stainless steel 1.4404 / 316L with female thread Rp
- Gasket: O-ring EPDM No. 748 410 008-011
- Union Nut: PEGF25
- Including Insulation made from NBR foam

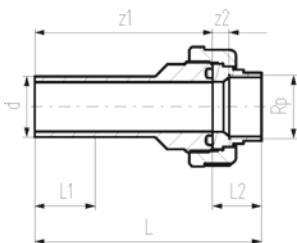

d (mm)	Rp (inch)	PN (bar)	Code GF	Code Reece	Weight (kg)	D (mm)	L (mm)	L1 (mm)	L2 (mm)	z1 (mm)	z2 (mm)
32	1	16	738 544 208	1470165	0.270	108	136	36	29	107	10
40	1 ¼	16	738 544 209	1470166	0.433	116	150	40	33	118	11
50	1 ½	16	738 544 210	1470167	0.587	126	158	44	34	124	13
63	2	16	738 544 211	1470168	0.883	139	175	48	39	136	14

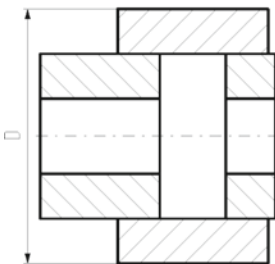



COOL-FIT 2.0 Union PE/PE

Model:

- Union bush: Spigot fitting PE100 SDR11, metric with free end
- Union End: Spigot fitting PE100 SDR11, metric with free end
- Gasket: O-ring EPDM No. 748 410 008-014
- Union Nut: PEGF25
- Including Insulation made from NBR foam

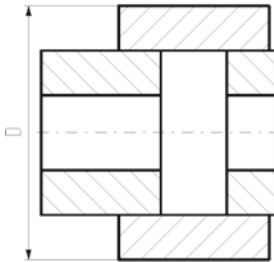
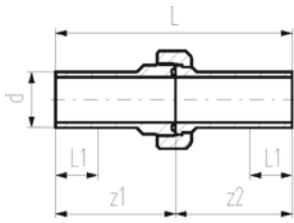

d (mm)	PN (bar)	Code GF	Code Reece	D (mm)	L (mm)	L1 (mm)	z1 (mm)	z2 (mm)
32	16	738 514 608	1470151	108	211	36	107	104
40	16	738 514 609	1470152	116	234	40	118	117
50	16	738 514 610	1470153	126	247	44	124	123
63	16	738 514 611	1470154	139	268	48	136	132
75	10	738 514 612	1470155	151	303	55	154	149
90	10	738 514 613	1470156	166	293	62	149	144
110	10	738 514 614	1470157	186	321	72	162	159



COOL-FIT 2.0 Adaptor Union PE/ABS

Model:

- Union bush: ABS Solvent cement socket
- Union End: Spigot fitting PE100 SDR11, metric with free end
- Gasket: O-ring EPDM No. 748 410 008-014
- Union Nut: ABS
- Including Insulation made from NBR foam

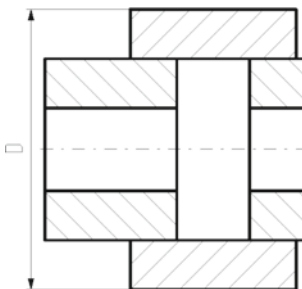
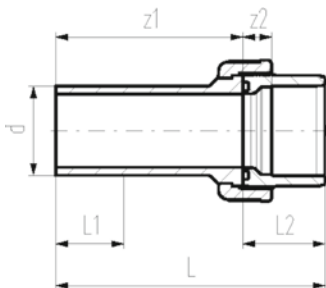

d (mm)	PN (bar)	Code GF	Code Reece	Weight (kg)	D (mm)	L (mm)	L1 (mm)	L2 (mm)	z1 (mm)	z2 (mm)
32	10	738 514 708	1470158	0.117	108	137	36	33	104	11
40	10	738 514 709	1470159	0.196	116	156	40	39	117	13
50	10	738 514 710	1470160	0.268	126	169	44	46	123	15
63	10	738 514 711	1470161	0.427	139	190	48	58	132	21
75	10	738 514 712	1470162	0.730	151	211	55	62	149	18
90	10	738 514 713	1470163	0.974	166	215	62	69	146	19
110	10	738 514 714	1470164	1.478	186	235	72	72	163	11

COOL-FIT 2.0/4.0 Adaptor fitting PE/stainless steel with male thread R



Model:

- Spigot fitting PE100 SDR11, metric with free end
- Stainless steel 1.4404 / 316L with male thread R
- Gasket: O-ring EPDM

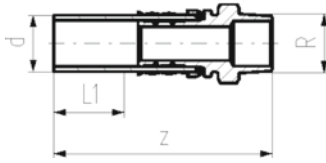

d (mm)	R (inch)	PN (bar)	Code GF	Code Reece	Weight (kg)	L1 (mm)	z (mm)
32	1/2	16	738 940 508	-	0.179	36	130
32	3/4	16	738 940 518	-	0.187	36	134
32	1	16	738 940 528	-	0.196	36	134
40	1 1/4	16	738 940 509	-	0.572	40	156
50	1 1/2	16	738 940 510	-	0.927	44	168
63	2	16	738 940 511	-	1.347	48	179

COOL-FIT 2.0/4.0 Adaptor fitting PE/stainless steel with female thread Rp



Model:

- Spigot fitting PE100 SDR11, metric with free end
- Stainless steel 1.4404 / 316L with femal thread Rp
- Gasket: O-ring EPDM

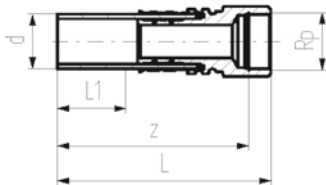

d (mm)	Rp (inch)	PN (bar)	Code GF	Code Reece	Weight (kg)	L (mm)	L1 (mm)	z (mm)
32	1/2	16	738 940 008	-	0.183	132	36	118
32	3/4	16	738 940 018	-	0.208	132	36	116
32	1	16	738 940 028	-	0.233	132	36	115
40	1 1/4	16	738 940 009	-	0.600	157	40	141
50	1 1/2	16	738 940 010	-	0.641	150	44	128
63	2	16	738 940 011	-	1.133	164	48	140

COOL-FIT 2.0/4.0 Adaptor fitting PE/stainless steel with loose union nut G



Model:

- Spigot fitting PE100 SDR11, metric with free end
- Stainless steel 1.4404 / 316L with loose union nut G
- Including flat seal EPDM

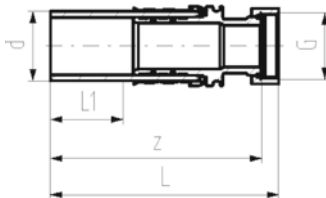

d (mm)	G (inch)	PN (bar)	Code GF	Code Reece	Weight (kg)	L (mm)	L1 (mm)	z (mm)
32	1/2	16	738 940 308	-	0.186	133	36	126
32	3/4	16	738 940 318	-	0.201	135	36	129
32	1	16	738 940 328	-	0.232	135	36	129
32	1 1/4	16	738 940 338	-	0.283	137	36	131
40	1 1/4	16	738 940 309	-	0.512	155	40	148
40	1 1/2	16	738 940 319	-	0.572	157	40	148
40	2	16	738 940 329	-	0.769	166	40	152
50	1 1/2	16	738 940 310	-	0.726	164	44	154
50	1 3/4	16	738 940 320	-	0.795	164	44	155
50	2	16	738 940 330	-	0.995	178	44	162
50	2 1/4	16	738 940 340	-	0.719	148	44	134
63	2	16	738 940 311	-	1.95	186	44	170
63	2 3/8	16	738 940 321	-	1.284	178	48	168
63	2 3/4	16	738 940 331	-	1.745	157	48	141

COOL-FIT 2.0/4.0 Adaptor fitting PE/Brass with male thread R



Model:

- Spigot fitting PE100 SDR11, metric with free end
- Brass CW617N with male thread R
- Gasket: O-ring EPDM

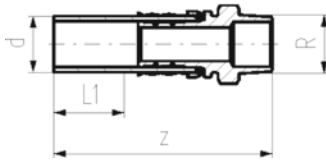

d (mm)	R (inch)	PN (bar)	Code GF	Code Reece	Weight (kg)	L1 (mm)	z (mm)
32	1/2	16	738 950 508	-	0.188	36	130
32	3/4	16	738 950 518	-	0.196	36	134
32	1	16	738 950 528	-	0.206	36	134
40	1 1/4		738 950 519	-	0.608	40	156
50	1 1/2	16	738 950 510	-	0.986	44	168
63	2	16	738 950 511	-	1.433	48	179

COOL-FIT 2.0/4.0 Adaptor fitting PE/Brass with female thread Rp



Model:

- Spigot fitting PE100 SDR11, metric with free end
- Brass CW617N with female thread Rp
- Gasket: O-ring EPDM

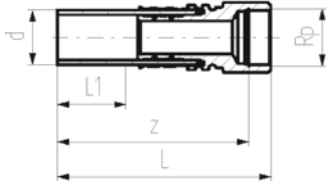

d (mm)	Rp (inch)	PN (bar)	Code GF	Code Reece	Weight (kg)	L (mm)	L1 (mm)	z (mm)
32	1/2	16	738 950 008	-	0.192	132	36	118
32	3/4	16	738 950 018	-	0.219	132	36	116
32	1	16	738 950 028	-	0.246	132	36	115
40	1 1/4	16	738 950 009	-	0.641	157	40	141
50	1 1/2	16	738 950 010	-	0.684	150	44	128
63	2	16	738 950 011	-	1.209	164	48	140

COOL-FIT 2.0/4.0 Adaptor fitting PE/Brass with loose union nut G



Model:

- Spigot fitting PE100 SDR11, metric with free end
- Brass CW617N with loose union nut G
- Including flat seal EPDM

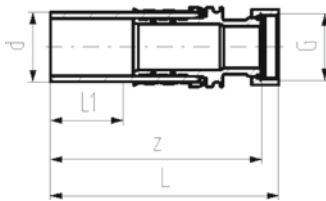

d (mm)	G (inch)	PN (bar)	Code GF	Code Reece	Weight (kg)	D (mm)	L (mm)	L1 (mm)	z (mm)
32	3/4	16	738 950 318	-	0.206	70	135	36	129
32	1	16	738 950 328	-	0.244	70	135	36	129
32	1 1/4	16	738 950 338	-	0.301	108	137	36	131
40	1 1/4	16	738 950 309	-	0.543	78	155	40	148
40	1 1/2	16	738 950 319	-	0.607	116	157	40	148
40	2	16	738 950 329	-	0.818	116	166	40	152
50	1 1/2	16	738 950 310	-	0.769	88	164	44	154
50	1 3/4	16	738 950 320	-	0.842	88	164	44	155
50	2	16	738 950 330	-	1.058	126	178	44	162
50	2 1/4	16	738 950 340	-	0.868	126	148	44	134
63	2	16	738 950 311	-	1.268	101	186	48	170
63	2 3/8	16	738 950 321	-	1.362	139	178	48	168
63	2 3/4	16	738 950 331	-	1.245	139	157	48	141

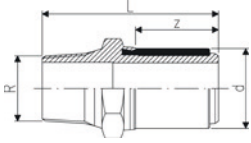

Transition adaptor PE/brass (CW617N) Male thread

- PE 100 SDR 11 (ISO S5)
- 16 bar

d (mm)	R (inch)	Code GF	Code Reece	Weight (kg)	L (mm)	z (mm)
20	1/2	720 920 706	1470035	0.133	75	33
25	3/4	720 920 707	1470036	0.182	76	33
32	1	720 920 708	1470037	0.257	80	35
32	1 1/4	720 920 718	1470041	0.370	82	35
32	1 1/2	720 920 728	1470045	0.437	82	35
40	1	720 920 719	1470042	0.358	84	39
40	1 1/4	720 920 709	1470038	0.405	86	39
40	1 1/2	720 920 729	1470046	0.454	86	39
50	1	720 920 720	1470043	0.505	88	43
50	1 1/4	720 920 730	1470047	0.539	90	43
50	1 1/2	720 920 710	1470039	0.514	90	43
63	1 1/4	720 920 721	1470044	0.739	94	47
63	1 1/2	720 920 731	1470048	0.709	94	47
63	2	720 920 711	1470040	0.762	98	47

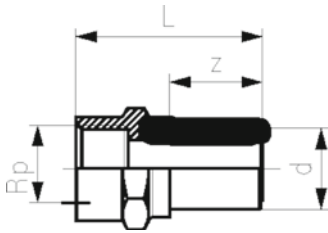

Transition adaptor PE/brass (CW617N) Female thread

- PE 100 SDR 11 (ISO S5)
- 16 bar

d (mm)	Rp (inch)	Code GF	Code Reece	Weight (kg)	L (mm)	z (mm)
32	1	720 920 208	1470029	0.250	71	35
40	1 1/4	720 920 209	1470030	0.386	77	39
50	1 1/2	720 920 210	1470031	0.520	81	43
63	1	720 920 221	1470312	0.780	83	47
63	1 1/4	720 920 231	-	1.062	85	47
63	1 1/2	720 920 241	1470034	0.740	85	47
63	2	720 920 211	1470032	0.729	89	47

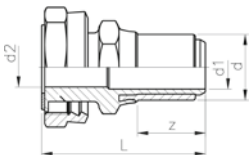

Transition adaptor PE/brass Loose nut (CW617N)

- PE 100 SDR 11 (ISO S5)
- 16 bar
- Incl. flat gasket for water applications (KTW / WRAS approved)

d (mm)	G (inch)	Code GF	Code Reece	Weight (kg)	d2 (mm)	L (mm)	z (mm)
25	3/4	720 920 207	1470023	0.152	15	68	32
32	1	720 920 008	1470024	0.235	20	72	34
32	1 1/4	720 920 018	1470027	0.356	22	76	34
50	1 1/2	720 920 010	1470025	0.584	29	87	42
63	1	720 920 021	1470028	0.804	20	87	46
63	2	720 920 011	1470026	1.018	36	95	46



**Transition adaptor PE/steel (stainless 1.4305)
Male thread**

- PE 100 SDR 11 (ISO S5)
- 16 bar

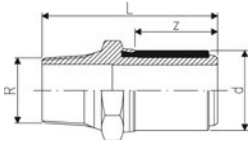

d (mm)	R (inch)	Code GF	Code Reece	Weight (kg)	L (mm)	z (mm)
20	1/2	724 920 706	1470055	0.120	75	33
25	3/4	724 920 707	1470056	0.179	76	33
32	1	724 920 708	1470057	0.244	80	35
40	1 1/4	724 920 709	1470058	0.380	86	39
50	1 1/2	724 920 710	1470059	0.478	90	43
63	1 1/2	724 920 721	1470062	0.653	98	47
63	2	724 920 711	1470060	0.722	98	47



**Transition adaptor PE/steel (stainless 1.4305)
Female thread**

- PE 100 SDR 11 (ISO S5)
- 16 bar

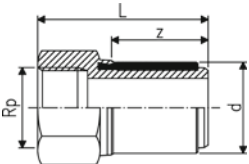

d (mm)	Rp (inch)	Code GF	Code Reece	Weight (kg)	L (mm)	z (mm)
20	1/2	724 920 206	1470049	0.128	65	33
25	3/4	724 920 207	1470050	0.181	66	33
32	1	724 920 208	1470051	0.237	71	35
40	1 1/4	724 920 209	1470052	0.373	77	39
50	1 1/2	724 920 210	1470053	0.527	81	43
63	2	724 920 211	1470054	0.733	89	47



**Transition Adaptor
PE/brass (CW612N) Male thread**

- PE 100 SDR 11 (ISO S5)
- 16 bar

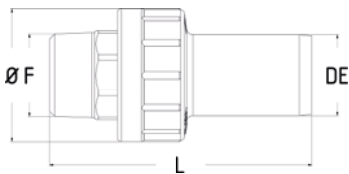

d (mm)	Rp (inch)	Code GF	Code Reece	Weight (kg)	L (mm)	A (mm)
32	1"	200064938	-	0.25	105	56
32	1 1/4"	200064939	-	0.38	155	56
40	1"	200064940	-	0.40	155	56
40	1 1/4"	200064941	-	0.40	120	56
40	1 1/2"	200064942	-	0.48	125	56
50	1"	200064943	-	0.45	115	57
50	1 1/2"	200064944	-	0.52	125	63
50	2"	200064945	-	0.70	130	57
63	1 1/2"	200064946	-	0.62	135	63
63	2"	200064947	-	0.73	140	63
75	2"	200064948	-	0.80	145	70
75	2 1/2"	200064949	-	1.20	155	70
90	3"	200064950	-	1.60	170	78
110	4"	200064951	-	2.90	200	87

**Transition Adapter
PE/Brass (CW612N) Female Thread**



- PE100 SDR11
- 16 bar

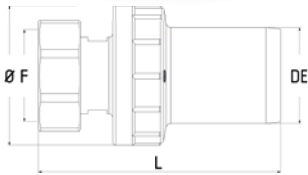

d (mm)	Rp (inch)	Code GF	Code Reece	Weight (kg)	L (mm)	A (mm)
32	1"	200064952	-	0.20	90	47
40	1"	200064953	-	0.25	90	56
40	1 1/4"	200064954	-	0.30	100	56
40	1 1/2"	200064955	-	0.32	100	56
50	1"	200064956	-	0.32	100	57
50	1 1/2"	200064957	-	0.35	100	57
50	2"	200064958	-	0.52	115	57
63	1 1/2"	200064959	-	0.45	115	63
63	2"	200064960	-	0.58	120	63
75	2 1/2"	200064961	-	0.75	130	70
90	3"	200064962	-	1.00	145	78
110	4"	200064963	-	1.90	160	87

**Transition Adapter
Stainless steel AISI 316 grade**



- PE100 SDR11
- 16 bar

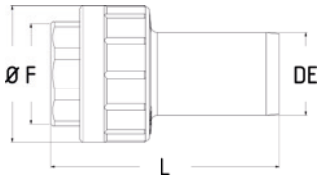

d (mm)	Rp (inch)	Code GF	Code Reece	Weight (kg)	L (mm)	A (mm)
32	1"	200064964	-	0.25	105	47
40	1 1/4"	200064965	-	0.40	120	56
40	1 1/2"	200064966	-	0.48	125	56
50	1 1/2"	200064967	-	0.52	125	57
50	2"	200064968	-	0.70	130	57
63	1 1/2"	200064969	-	0.62	135	63
63	2"	200064970	-	0.73	140	63
75	2"	200064971	-	0.80	145	70
75	2 1/2"	200064972	-	1.20	155	70
90	3"	200064973	-	1.60	170	78
110	4"	200064974	-	2.90	200	87

**Transition Adapter
Stainless steel AISI 316 grade**



- PE100 SDR11
- 16 bar

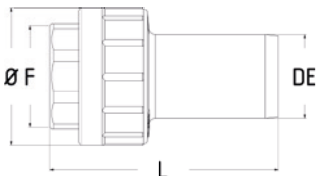

d (mm)	Rp (inch)	Code GF	Code Reece	Weight (kg)	L (mm)	A (mm)
32	1"	200064975	-	0.20	90	47
40	1 1/4"	200064976	-	0.30	100	56
40	1 1/2"	200064977	-	0.32	100	56
50	1 1/2"	200064978	-	0.35	100	57
50	2"	200064979	-	0.52	115	57
63	1 1/2"	200064980	-	0.45	115	63
63	2"	200064981	-	0.58	120	63
75	2 1/2"	200064982	-	0.75	130	70
90	3"	200064983	-	1.00	145	78
110	4"	200064984	-	1.90	160	87

COOL-FIT 2.0/4.0 Adaptor Union PE/Stainless steel with male thread R

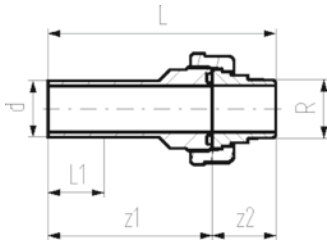

Model:

- Union bush: Spigot fitting PE100 SDR11, metric with free end
- Union End: Stainless steel 1.4404 / 316L with male thread R
- Gasket: O-ring EPDM No. 748 410 008-011
- Union Nut: PEGF25

d (mm)	R (inch)	PN (bar)	Code GF	Code Reece	Weight (kg)	L (mm)	L1 (mm)	z1 (mm)	z2 (mm)
32	1	16	738 540 708	1470653	0.276	147	36	107	40
40	1¼	16	738 540 709	1470654	0.495	163	40	117	46
50	1½	16	738 540 710	1470655	0.606	172	44	124	48
63	2	16	738 540 711	1470656	1.000	191	48	136	55

COOL-FIT 2.0/4.0 Adaptor Union PE/Stainless steel with female thread Rp

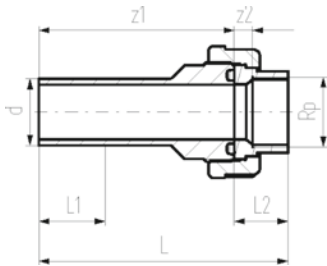

Model:

- Union bush: Spigot fitting PE100 SDR11, metric with free end
- Union End: Stainless steel 1.4404 / 316L with female thread Rp
- Gasket: O-ring EPDM No. 748 410 008-011
- Union Nut: PEGF25

d (mm)	R (inch)	PN (bar)	Code GF	Code Reece	Weight (kg)	L (mm)	L1 (mm)	z1 (mm)	z2 (mm)
32	1	16	738 540 208	1470649	0.234	147	36	107	40
40	1¼	16	738 540 209	1470650	0.387	163	40	117	46
50	1½	16	738 540 210	1470651	0.530	172	44	124	48
63	2	16	738 540 211	1470652	0.807	191	48	136	55

Flanged Connections

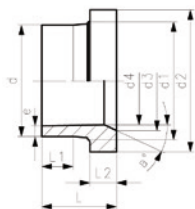

Un-insulated Flange Adapter

- PE100 SDR 11, metric
- Suitable for flange connections to metric (from d110 also to ANSI/ASME B16.5)
- Gasket: Profile flange gasket NBR No. 45 44 07, EPDM No. 48 44 07

d (mm)	DN (mm)	PN (bar)	Code GF	Code Reece	Weight (kg)
32	25	16	753 800 008	1407423	0.056
40	32	16	753 800 009	1407424	0.081
50	40	16	753 800 010	1407425	0.119
63	50	16	753 800 011	1422168	0.187
75	65	16	753 800 012	1407427	0.314
90	80	16	753 800 013	1422169	0.471
110	100	16	753 800 014	1407429	0.706
140	125	16	753 800 016	1422181	1.348

d (mm)	DN (mm)	d1 (mm)	d2 (mm)	d3 (mm)	d4 (mm)	L (mm)	L1 (mm)	L2 (mm)	e (mm)
32	25	40	68	-	26	91.5	61.0	10	3.0
40	32	50	78	-	32	94.5	61.5	11	3.7
50	40	61	88	-	40	90.0	62.0	12	4.6
63	50	75	102	-	51	98.0	69.0	14	5.8
75	65	89	122	66	61	125.0	89.0	16	6.8
90	80	105	138	78	73	140.0	103.0	17	8.2
110	100	125	158	100	90	160.0	114.0	18	10.0
140	125	155	188	127	114	200.0	147.0	25	12.7

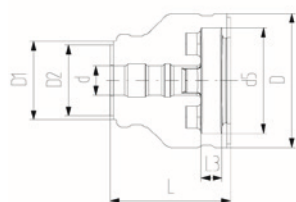
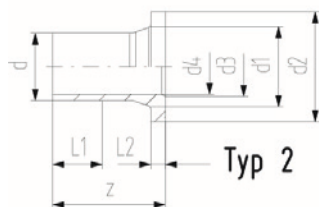
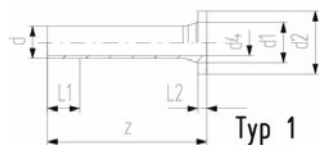
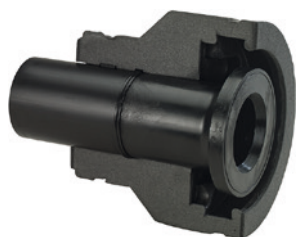

COOL-FIT 2.0/4.0 Flange Adaptor

- PE100 SDR 11 PN16, metric
- Suitable for flange connections to metric (from d110 also to ANSI/ASME B16.5)
- Gasket: Profile flange gasket NBR No. 45 44 07, EPDM No. 48 44 07
- Type 1 without chamfer, Type 2 with chamfer
- Separate Fittings type A needed for joining

Model:

Backing ring and gasket not included

d (mm)	DN (mm)	PN (bar)	Code GF	Code Reece	Weight (kg)
32	25	16	738 710 008	1470173	0.051
40	32	16	738 710 009	1470174	0.075
50	40	16	738 710 010	1470175	0.900
63	50	16	738 710 011	1470176	0.173
75	65	16	738 710 012	1470177	1.210
90	80	16	738 710 013	1470178	1.193
110	100	16	738 710 014	1470179	1.574
140	125	16	738 710 016	1470180	2.412

d (mm)	DN (mm)	D (mm)	D1 (mm)	D2 (mm)	L (mm)	L1 (mm)	L2 (mm)	L3 (mm)	z (mm)	d1 (mm)	d2 (mm)	d3 (mm)	d4 (mm)	d5 (mm)	Type
32	25	135	90	75	162	36	10	26	190	40	68	-	26	121	1
40	32	170	110	90	165	40	11	28	197	50	78	-	32	146	1
50	40	180	110	90	178	44	12	30	214	61	88	-	40	156	1
63	50	200	125	110	230	48	14	32	270	75	102	-	51	171	1
75	65	220	140	125	232	55	16	34	279	89	122	-	61	191	2
90	80	240	160	140	245	62	17	35	299	105	138	78	73	206	2
110	100	270	180	160	254	72	18	36	320	125	158	100	90	235	2
140	125	300	225	200	299	84	25	38	383	155	188	127	127	256	2

Backing Rings ANSI Class 150

- AL: Number of holes
- Material: ASTM A105 / Zinc-coated AS NZS 4680-2006

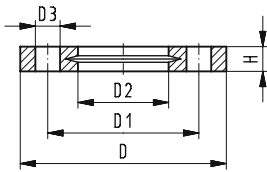

d (mm)	Inch Size (inch)	PN (bar)	GF Code (Galvanised)	GF Code (Stainless Steel)	Weight (kg)	D (mm)	D1 (mm)	D2 (mm)	D3 (mm)	H (mm)	AL	SC
32	1	16	200 059 784	200 059 907	0.78	108	79.5	42	16	14.2	4	M14
40	1 1/4	16	200 059 785	200 059 908	0.98	117	89.0	51	16	15.7	4	M14
50	1 1/2	16	200 059 786	200 059 909	1.23	127	98.5	62	16	17.5	4	M14
63	2	16	200 059 787	200 059 910	1.82	152	120.5	78	20	19.0	4	M18
75	2 1/2	16	200 059 788	200 059 911	3.00	178	139.5	92	20	22.3	4	M18
90	3	16	200 059 789	200 059 912	3.39	191	152.0	110	20	23.9	4	M18
110	4	16	200 059 790	200 059 913	4.88	229	190.5	128	20	23.9	8	M18
125	5	16	200 059 791	200 059 914	6.10	254	216.0	140	22	23.9	8	M18
140	5	16	200 059 792	200 059 915	5.26	254	216.0	158	22	23.9	8	M20
160	6	16	200 059 793	200 059 916	6.68	279	241.0	178	22	25.4	8	M20
180	6	16	200 059 794	200 059 917	5.68	279	241.0	195	22	25.4	8	M20
200	8	16	200 059 795	200 059 918	10.34	343	298.5	235	22	28.4	8	M20
225	8	16	200 059 796	200 059 919	10.09	343	298.5	238	22	28.4	8	M20
250	10	16	200 059 797	200 059 920	13.86	406	362.0	288	26	30.2	12	M24
280	10	16	200 059 798	200 059 921	13.20	406	362.0	294	26	30.2	12	M24
315	12	16	200 059 799	200 059 922	20.81	482	432.0	345	26	31.8	12	M24
355	14	16	200 059 800	200 059 923	28.70	533	476.0	376	30	35.0	12	M27
400	16	16	200 059 801	200 059 924	36.59	600	540.0	430	30	36.6	16	M27
450	18	16	200 059 802	200 064 776	29.19	635	578.0	516	33	39.6	16	M30

Backing Rings AS4087 PN16

- AL: Number of holes
- Material: ASTM A105 / Zinc-coated AS NZS 4680-2006

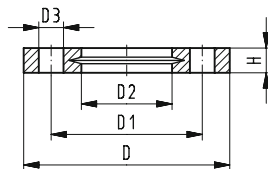

d (mm)	DN (mm)	PN (bar)	GF Code (Galvanised)	GF Code (Stainless Steel)	Weight (kg)	D (mm)	D1 (mm)	D2 (mm)	D3 (mm)	H (mm)	AL	SC
32	25	16	200 059 784	200 059 879	0.53	115	83	42	14	8	4	M12
40	32	16	200 059 785	200 059 880	0.55	120	87	51	14	8	4	M12
50	40	16	200 059 786	200 059 881	0.76	135	98	62	14	9	4	M12
63	50	16	200 059 787	200 059 882	0.94	150	114	78	18	10	4	M16
75	65	16	200 059 788	200 059 883	1.09	165	127	92	18	10	4	M16
90	80	16	200 059 789	200 059 884	1.43	185	146	110	18	11	4	M16
110	100	16	200 059 790	200 064 101	2.31	215	178	128	18	13	4	M16
125	125	16	200 059 791	200 064 102	2.05	215	178	135	18	13	4	M16
140	125	16	200 059 792	200 064 103	3.03	255	210	158	18	13	8	M16
160	150	16	200 059 793	200 064 104	3.57	280	235	178	18	13	8	M16
180	150	16	200 059 794	200 064 105	3.06	280	235	188	18	13	8	M16
200	200	16	200 059 795	200 064 106	6.43	335	292	235	18	19	8	M16
225	200	16	200 059 796	200 064 107	9.07	370	324	240	18	19	8	M16
250	250	16	200 059 797	200 064 108	9.13	405	356	288	22	19	8	M20
280	250	16	200 059 798	200 064 109	10.04	405	356	294	22	23	8	M20
315	300	16	200 059 799	200 064 110	11.76	455	406	338	22	23	12	M20
355	350	16	200 059 800	200 064 111	23.54	525	470	376	26	30	12	M24
400	400	16	200 059 801	200 064 112	26.46	580	521	430	26	30	12	M24
450	450	16	200 059 802	200 064 113	25.24	640	584	516	26	30	12	M24

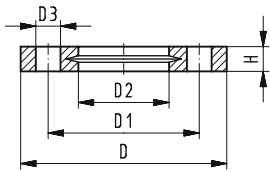

Backing Rings Table E

- AL: Number of holes
- Material: ASTM A105 / Zinc-coated AS NZS 4680-2006

d (mm)	DN (mm)	PN (bar)	GF Code (Galvanised)	GF Code (Stainless Steel)	Weight (kg)	D (mm)	D1 (mm)	D2 (mm)	D3 (mm)	H (mm)	AL	SC
32	25	14	200 059 728	200 059 879	0.53	115	83	42	14	8	4	M12
40	32	14	200 059 729	200 059 880	0.55	120	87	51	14	8	4	M12
50	40	14	200 059 730	200 059 881	0.76	135	98	62	14	9	4	M12
63	50	14	200 059 731	200 059 882	0.94	150	114	78	18	10	4	M16
75	65	14	200 059 732	200 059 883	1.09	165	127	92	18	10	4	M16
90	80	14	200 059 733	200 059 884	1.43	185	146	110	18	11	4	M16
110	100	14	200 059 762	200 059 885	2.20	215	178	128	18	13	8	M16
125	100	14	200 059 845	200 059 886	2.05	215	178	135	18	13	8	M16
140	125	14	200 059 765	200 059 888	3.26	255	210	158	18	14	8	M16
160	150	14	200 059 766	200 059 889	4.53	280	235	178	22	17	8	M20
180	150	14	200 059 767	200 059 890	3.86	280	235	195	22	17	8	M20
200	200	14	200 059 768	200 059 891	6.28	335	292	235	22	19	8	M20
225	200	14	200 059 769	200 059 892	6.11	335	292	238	22	19	8	M20
250	250	14	200 059 770	200 059 893	10.14	405	356	290	22	22	12	M20
280	250	14	200 059 771	200 059 894	9.34	405	356	300	22	22	12	M20
315	300	14	200 059 772	200 059 895	13.17	455	406	338	26	25	12	M24
355	350	14	200 059 773	200 059 896	22.75	525	470	376	26	29	12	M24
400	400	14	200 059 774	200 059 897	28.54	580	521	430	26	32	12	M24
450	450	14	200 059 775	200 059 898	28.85	640	584	516	26	35	16	M24

Profile Flange Gasket, metric EPDM

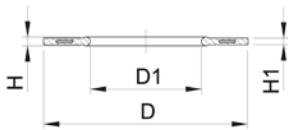

Model:

- For all metric GF Flange Adaptors
- Hardness: 70° Shore EPDM, 75° Shore FKM
- EPDM: approved acc. to DVGW Water W 270, KTW recommendation
- Centering on the inner diameter of the screw crown
- Material steel insert: carbon steel
- Rubber-steel body combined with rubber profile cord ring up to d630
- Rubber-steel body ideal for big dimensions (d710 - d1000)

di FA are the suitable inner diameters of flange adaptors

d (mm)	PN (bar)	DN (mm)	EPDM Code	Code Reece	Weight (kg)	D (mm)	D1 (mm)	di FA (mm)	H (mm)	H1 (mm)
32	16	25	748 440 708	-	0.019	71	28	18 - 28	4	3
40	16	32	748 440 709	-	0.026	82	40	30 - 40	4	3
50	16	40	748 440 710	-	0.039	92	46	36 - 46	4	3
63	16	50	748 440 711	-	0.050	107	58	48 - 58	5	4
75	16	65	748 440 712	1470535	0.082	127	69	59 - 69	5	4
90	16	80	748 440 713	1470536	0.083	142	84	73 - 84	5	4
110	16	100	748 440 714	-	0.127	162	104	94 - 104	6	5
140	16	125	748 440 716	-	0.173	192	137	127 - 137	6	5

COOL-FIT 2.0 Flexible Hoses

COOL-FIT 2.0 Flexible hose



Model:

- EPDM flexible hose with stainless steel protection
- Brass adaptors
- Pre-Insulation made from NBR foam with outer jacket impact resistant and tearproof
- With loose union nut G on one end and male thread GA on the other

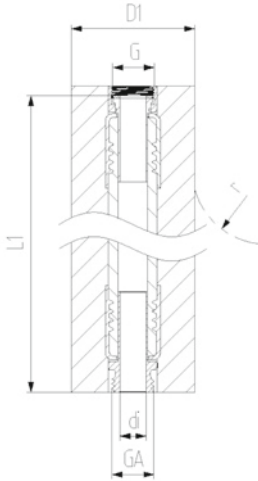

d (mm)	DN (mm)	G/GA (inch)	PN (bar)	Code GF	Code Reece	L1 (mm)	di (mm)	D1 (mm)	r (mm)
20	15	1/2"	10	738 924 206	1470662	1000	15	39	119
25	20	3/4"	10	738 924 207	1470229	1000	19	44	156
32	25	1"	10	738 924 208	1470230	1000	25	51	192
40	32	1 1/4"	8	738 924 209	1470231	1500	32	59	252
50	40	1 1/2"	6	738 924 210	1470232	2000	38	69	312
63	50	2"	6	738 924 211	147663	2000	52	82	372

COOL-FIT 2.0 Valves



COOL-FIT 2.0 Ball valve type 546 hand-operated

Model:

- Material: PVC-U with spigot PE100 SDR11, metric
- Ball seals PTFE
- Integrated stainless steel mounting inserts
- Including insulation half shells

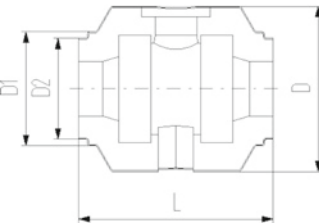
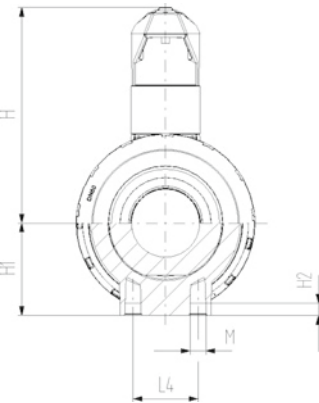
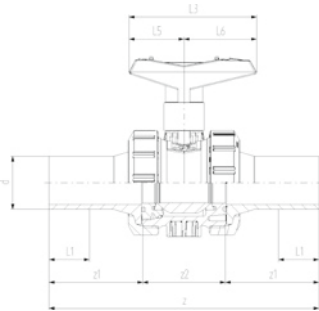

	d (mm)	DN (mm)	PN (bar)	kv-value ($\Delta p=1$ bar) (l/min)	Code GF	Code Reece	Weight (kg)
*	32	25	16	700	138 546 308	1470000	0.560
*	40	32	16	1000	138 546 309	1470001	0.900
*	50	40	16	1600	138 546 310	1470002	1.190
*	63	50	16	3100	138 546 311	1470003	2.100
	75	65	16	5000	138 546 312	1470004	5.550
	90	80	16	7000	138 546 313	1470005	8.150

	d (mm)	DN (mm)	D (mm)	D1 (mm)	D2 (mm)	L (mm)	L1 (mm)	L3 (mm)	L4 (mm)	H (mm)	H1 (mm)	H2 (mm)	z (mm)	z1 (mm)	z2 (mm)
*	32	25	135	97	82	152	36	97	25	98	36	12	223	76	71
*	40	32	157	117	97	170	40	128	45	119	44	15	249	82	85
*	50	40	169	117	97	184	44	128	45	125	51	15	271	91	89
*	63	50	204	132	117	227	48	152	45	150	64	15	321	110	101
	75	65	235	147	132	276	55	270	70	194	85	15	386	125	136
	90	80	255	168	147	297	62	270	70	200	105	15	421	140	141

	d (mm)	DN (mm)	M	Closest Inch (inch)
*	32	25	M8	1
*	40	32	M8	1¼
*	50	40	M8	1½
*	63	50	M8	2
	75	65	M8	1½
	90	80	M8	3



COOL-FIT 2.0 Butterfly valve kit type 567 hand-operated

Model:

- Material: PVC-U with spigot PE100 SDR11, metric
- Including flange adaptors, backing flanges PP-Steel, bolts and insulation half shells

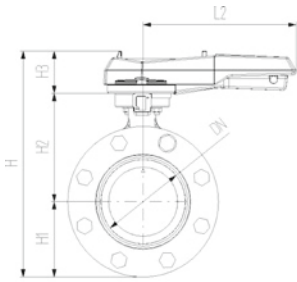

d (mm)	DN (mm)	PN (bar)	kv-value ($\Delta p=1$ bar) (l/min)	EPDM Code	Reece Code	Weight (kg)
110	100	10	6500	138 567 314	1470012	3500
140	125	10	11500	138 567 316	1470013	4500

d (mm)	DN (mm)	D (mm)	D1 (mm)	D2 (mm)	L (mm)	L1 (mm)	L2 (mm)	L3 (mm)	z (mm)	z1 (mm)	z2 (mm)	H (mm)	H1 (mm)	H2 (mm)	H3 (mm)
110	100	260	188	168	552	72	255	106	696	320	56	325	104	167	55
140	125	287	233	208	662	84	255	106	830	383	64	352	117	181	55

d (mm)	DN (mm)	Closest Inch (inch)
110	100	4
140	125	5

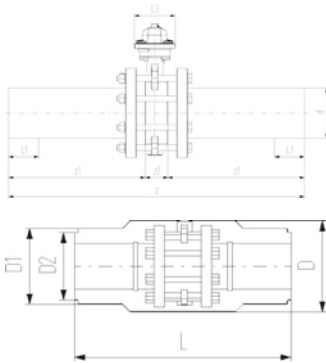



COOL-FIT 2.0 Ball valve type 546 PVC-U bare shaft

Model:

- Material: PVC-U with spigot PE100 SDR11, metric
- Ball seals PTFE
- Integrated stainless steel mounting inserts
- Interface according to DIN EN ISO 5211
- Including insulation half shells

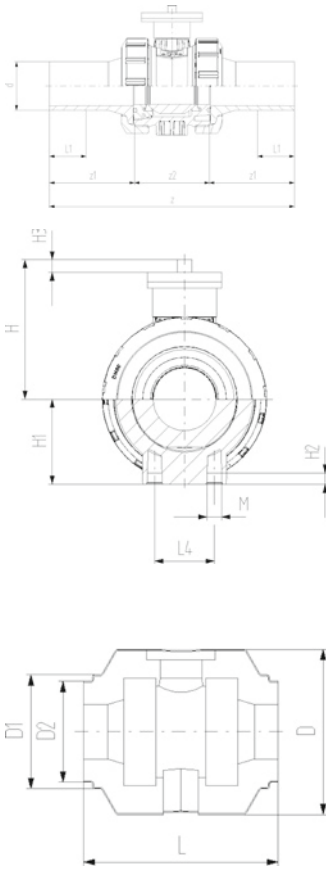

d (mm)	DN (mm)	PN (bar)	kv-value ($\Delta p=1$ bar) (l/min)	EPDM Code	Reece Code	Weight (kg)
32	25	16	700	138 546 408	1470006	0.560
40	32	16	1000	138 546 409	1470007	0.900
50	40	16	1600	138 546 410	1470008	1.190
63	50	16	3100	138 546 411	1470009	0.100
75	65	16	5000	138 546 412	1470010	5.550
90	80	16	7000	138 546 413	1470011	8.150

d (mm)	DN (mm)	D (mm)	D1 (mm)	D2 (mm)	L (mm)	L1 (mm)	H (mm)	H1 (mm)	H2 (mm)	H3 (mm)	z (mm)	z1 (mm)	z2 (mm)	M (mm)
32	25	135	97	82	152	36	72	12	11	223	76	71	71	M6
40	32	157	117	97	170	40	84	15	11	249	82	85	85	M8
50	40	169	117	97	184	44	90	15	11	271	91	89	89	M8
63	50	204	132	117	227	48	105	15	10	321	110	101	101	M8
75	65	235	147	132	276	55	177	15	21	386	125	136	136	M8
90	80	255	168	147	297	62	189	15	21	421	140	141	141	M8

d (mm)	DN (mm)	Closest Inch (inch)	Hole pattern
32	25	1	F05/F03
40	32	1 ¼	F05/F03
50	40	1 ½	F05/F03
63	50	2	F05/F03
75	65	2 ½	F07
90	80	3	F07



COOL-FIT 2.0 Butterfly valve kit type 567 bare shaft

Model:

- Material: PVC-U with spigot PE100 SDR11, metric
- Interface F07 according to DIN/ISO 5211
- Including flange adaptors, backing flanges PP-Steel, bolts and insulation half shells

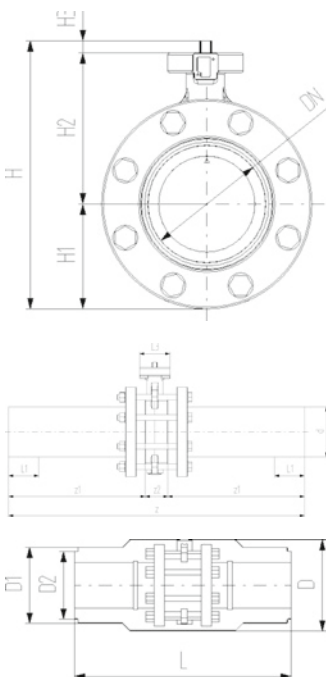

d (mm)	DN (mm)	PN (bar)	kv-value ($\Delta p=1$ bar) (l/min)	EPDM Code	Reece Code
110	100	10	6500	138 567 414	1470014
140	125	10	11500	138 567 416	1470015

d (mm)	DN (mm)	D (mm)	D1 (mm)	D2 (mm)	L (mm)	L1 (mm)	L3 (mm)	z (mm)	z1 (mm)	z2 (mm)	H1 (mm)	H2 (mm)	H3 (mm)	Closest Inch (inch)
110	100	260	188	168	552	72	106	696	320	56	104	167	55	4
140	125	287	233	208	662	84	106	830	383	64	117	181	55	5

COOL-FIT 2.0 Accessories

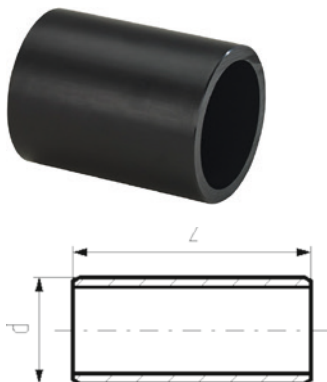

COOL-FIT 2.0/4.0 Barrel nipple

Model:

- PE100, SDR11, metric
- For the shortest possible connection between fittings

d (mm)	PN	Code GF	Code Reece	Weight (kg)	z (mm)	Closest Inch (inch)
32	10	738 910 408	1470199	0.020	72	1
40	10	738 910 409	1470200	0.034	80	1 ¼
50	10	738 910 410	1470201	0.059	88	1 ½
63	10	738 910 411	1470202	0.101	96	2
75	10	738 910 412	1470203	0.162	110	2 ½
90	10	738 910 413	1470204	0.264	124	3
110	10	738 910 414	1470205	0.454	144	4
140	10	738 910 416	1470206	0.855	168	5

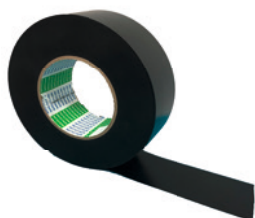

COOL-FIT 2.0 Outdoor Tape

- High performance vinyl tape
- Perfect air and moisture tight seal
- Weather resistant
- NO51A, 30.5m roll

D (mm)	d-d (mm)	Code GF	Code Reece	Weight (kg)	Length (m)	Width (mm)
75-200	32-140	200064936	1470695	0.96	30.5	50

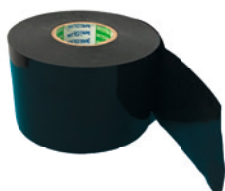

COOL-FIT 2.0 Underground Tape

- Butyl rubber self fusing tape with a self-adhesive layer
- Superior watertight properties and durability
- NO.55, 10m roll

D (mm)	d-d (mm)	Code GF	Code Reece	Weight (kg)	Length (m)	Width (mm)
75-200	32-140	200064937	1470696	0.26	10	40



COOL-FIT 2.0 Outdoor and Underground welding indicator-kit

Model:

- Type A suitable for COOL-FIT 2.0 fittings d32-d110mm
- Type B suitable for COOL-FIT 2.0 d140mm fittings

d (mm)	Code GF	Code Reece	Weight (kg)	Type	Pieces/Kit
140 - 225	738 010 052	1470631	0.090	A	20
160 - 225	738 010 053	1470632	0.200	B	10



COOL-FIT 2.0 adhesive ring

Model:

- Double sided for sealing connections of fittings with barrel nipple

d (mm)	D (mm)	Code GF	Code Reece	Weight (kg)
32	75	738 010 012	1470063	0.002
40, 50	90	738 010 013	1470064	0.002
63	110	738 010 014	1470065	0.003
75	125	738 010 015	1470066	0.003
90	140	738 010 016	1470067	0.003
110	160	738 010 017	1470068	0.005
140	200	738 010 019	1470069	0.006



COOL-FIT 2.0 fixed point

Model:

- The product consists of two components namely electrofusion tapes and pipe brackets.
- Electrofusion welded tape as permanent connection to transmit the forces that occur in the pipe to the fixed point.
- The delivered pipe brackets are needed to deliver welding pressure during installation and give stability during operation.
- For welding, use an MSA2.x, MSA4.x, MSA 250, 300, 350, 400 or commercially available 220 V fusion machines.
- If you use an MSA fusion machine from GF Piping Systems, use the 799 350 339 adapter or the 790 156 032 y-cable set.
- Please take note of the maximum allowed forces for this version in the table below.
- **Fixed point brackets and cross braces have to be calculated and obtained by the installer. They are not included in the fixed point set from GF.**

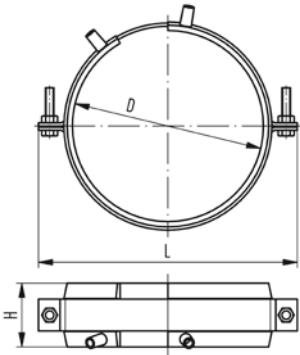

D (mm)	d (mm)	Code GF	Code Reece	Weight (kg)	L (mm)	H (mm)	max. Force (kN)	Closest Inch (inch)
75	32	738 912 012	1470207	0.750	150	60	2.0	1
90	40 - 50	738 912 013	1470208	0.895	170	60	3.0 / 5.0	1 ¼ / 1 ½
110	63	738 912 014	1470209	0.904	180	60	8.0	2
125	75	738 912 015	1470210	1.103	215	60	10.0	2 1/2
140	90	738 912 016	1470211	1.188	220	60	10.0	3
160	110	738 912 017	1470212	1.177	255	60	10.0	4
200	140	738 912 019	1470213	1.600	310	60	10.0	5



COOL-FIT Y cables kit

- The COOL-FIT Y cables are used to speed up the installation of the fixed points electrofusion tapes. The Y cables allow the welding in parallel of 2 E-Tapes, halving the total duration of the fusion process.
- Compatible with all MSA Units

Type	Code GF	Code Reece	Weight (kg)
4 leads cable with 2mm plugs in output	790 156 032	-	0.385



COOL-FIT 2.0/4.0 Adhesive Cement

Model:

- For the jointing of NBR foam insulations of flexible hoses and transition fittings

Code GF	Code Reece	SP	Weight (kg)
738 010 060	1470071	1	0.240



COOL-FIT 2.0/4.0 Adhesive tape

Model:

- For the jointing of NBR foam insulations of flexible hoses and transition fittings
- 30m on a roll

Code GF	Code Reece	SP	Weight (kg)
738 010 065	1470072	1	0.400



Tangit KS Cleaner

- Special cleaner for plastic fusion connections in the material of PP, PE, PVDF and PB
- Suitable for Tangit Rapid. Must not be used for solvent cementing
- DVGW approved
- DW 5290 BR 0464

Size	Code GF	Code Reece	Weight (kg)
1 litre	799 298 023	1470617	0.872



Tangit KS - Cleaning Tissues

- Special cleaner for plastic fusion connections in the material of PP, PE, PVDF and PB
- Suitable for Tangit Rapid. Must not be used for solvent cementing
- For plastic welding joints PB, PE, PP, PVDF
- DW 5290 BR 0464
- DVGW approved

Contents	Code GF	Code Reece	Weight (kg)
1 dispenser with 100 tissues	799 298 024	1470557	0.333



Marker

Type	Code GF	Code Reece	Weight (kg)
silver	799 350 364	1470618	0.010

KLIP-IT pipe clip type 061 PP metric



Model:

- Material: clip and safety clip PP black, UV resistant
- d16 - d63: height designed for ball valve type 546 and 543
- **Minimum order quantity: standard packagings SP**

d (mm)	d (inch)	Code GF	Code Reece	SP	Weight (kg)
75	2 ½	167 061 012	1470022	10	0.057
90	3	167 061 013	1470565	10	0.092
110	4	167 061 014	1470566	10	0.117
125	-	167 061 015	1470567	10	0.180
140	5	167 061 016	1470568	10	0.224
160	-	167 061 017	1470569	10	0.242

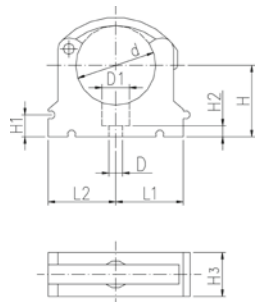

d (mm)	D (mm)	D1 (mm)	H (mm)	H1 (mm)	H2 (mm)	H3 (mm)	L1 (mm)	L2 (mm)	SC	Closest Inch (inch)
75	9	17	58	10	10	25	52	52	M8	2 ½
90	9	17	65	10	10	28	65	65	M8	3
110	9	17	75	10	10	28	79	79	M8	4
125	9	17	90	10	10	32	88	88	M8	-
140	9	17	110	10	10	32	98	98	M8	5
160	9	17	108	10	10	32	109	109	M8	6

KLIP-IT spacer type 061 PP

Model:

- For pipe clips type 061/061H, PP black, UV resistant
- **Minimum order quantity: standard packaging SP**

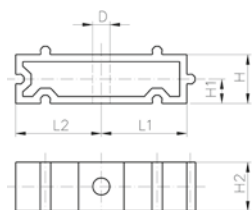

d (mm)	Inch (inch)	Code GF	Code Reece	SP	Weight (kg)	D (mm)	L1 (mm)	L2 (mm)	H (mm)	H1 (mm)	H2 (mm)	SC
75	2 ½	167 061 162	1470570	10	0.027	9	52	52	20	10	25	M8
90	3	167 061 163	1470571	10	0.039	9	65	65	20	10	28	M8
110	4	167 061 164	1470572	10	0.048	9	79	79	20	10	28	M8
125	4 ½	167 061 165	1470573	10	0.059	9	88	88	20	10	32	M8
140	5	167 061 166	1470574	10	0.065	9	98	98	20	10	32	M8
160	6	167 061 167	1470575	10	0.071	9	109	109	20	10	32	M8

Pipe clip type 060 PP metric

Model:

- Material: clip and safety clip PP black, UV resistant
- **Minimum order quantity: standard packaging SP or gross packaging GP**
- Accidental opening of the safety clip is not possible
- Clip and safety clip are not assembled in the packaging.
- Pipes with flanges can be installed directly

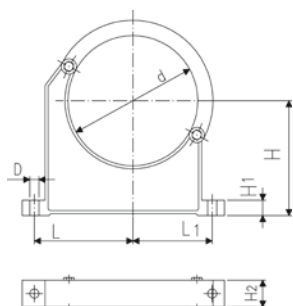
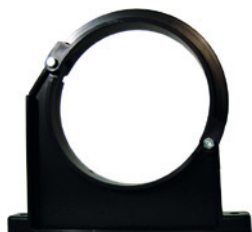

d (mm)	GF Code	Code Reece	SP	Weight (kg)	D (mm)	L (mm)	L1 (mm)	H (mm)	H1 (mm)	H2 (mm)	SC	Closest Inch (mm)
90	167 060 038	1470017	10	0.144	9	89	71	105	15	33	M 8	3
110	167 060 039	1470018	10	0.158	9	94	80	115	15	33	M 8	4
125	167 060 040	1470019	10	0.249	11	116	91	130	20	35	M10	-

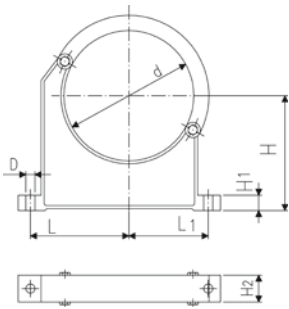

d (mm)	Code GF	Reece Code	SP	Weight (kg)	D (mm)	L (mm)	L1 (mm)	H (mm)	H1 (mm)	H2 (mm)	SC	Closest Inch (inch)
140	167 060 041	1470020	10	0.260	11	121	99	130	20	35	M10	5
160	167 060 042	1470021	10	0.296	11	131	107	148	20	35	M10	6
180	167 060 043	1470564	10	0.327	11	143	115	163	20	35	M10	7
200	167 060 019	1470016	5	0.539	13	152	120	175	25	39	M12	8

Pipe bracket spacing

The pipe bracket spacing have been determined for conveying water on the basis of a specific deflection of the pipe between two clamps considered acceptable.

The pipe bracket spacing for COOL-FIT 2.0 pipe is always consistent independent of pressure and temperature.

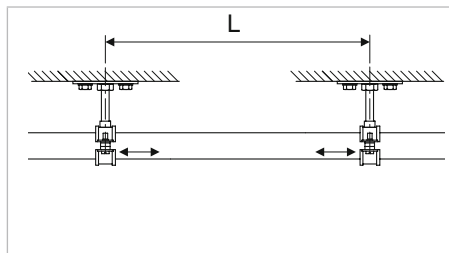

L Pipe clamp spacing

Pipe clamp intervals L for COOL-FIT 2.0

d/D (mm)	32/75	40/90	50/90	63/110	75/125	90/140	110/160	140/200
L (mm)	1600	1700	1700	1850	1950	2000	2100	2350

COOL-FIT 2.0 Tools



COOL-FIT 2.0/4.0 Foam removal and peeling tool

Model:

- Tool for foam removal and peeling of COOL-FIT 2.0 and 4.0 pipes

d (mm)	Code GF	Code Reece	Weight (kg)
32-90	799 738 001	1470283	10.500
110-225	799 738 003	1470284	16.500

MSA 2.1 Automatic Electrofusion Unit with protocols retrieval



The MSA 2.1 automatic electro fusion unit combines light weight and high efficiency, thanks to its inverter technology and furthermore provides fusion documentation in PDF. The unit is extremely fast and simple, with three basic operations required to operator: connect, scan, start the fusion. It is robust, safe and ergonomic.

All is meant to simplify the job: the barcode scanner, for long distance reading, the cooling system to joint in series, the icon system, to keep the interaction between user and machine intuitive. The entire welding process is controlled and regulated with energy output compensation depending on ambient temperature and the indication of cooling time.

The unit has 1000 protocols permanently stored in the internal memory. The user can copy the fusion reports in an USB stick to print them out in PDF format.

Scope of delivery includes: transport box, angle adapters (4.0 mm and 4.7 mm), operating instructions, START/STOP badge and USB memory stick with PC applications.

Technical Data:

- Operating temperature: -20°C to +50°C
- Mains voltage and frequency: 230V (190V - 265V), 50-60Hz
- Fusion voltage: 8-42 V (48 V)
- Fusion data input mode: bar code, manual
- Fusion current: 90 A (max)
- Suggested power generators: 3.5 kVA
- USB Port: Type A
- Protection factor: Class 1 / IP 65
- Mains cable: 4 m / Fusion cable: 4 m
- Weight: ca. 11.9 kg
- Display: Graphical LCD, adjustable contrast
- Independent from languages

Type	Code GF	Code Reece	Code (kg)
Barcode scanner, transport case, mini Welding Book	790 156 003	1470286	20.000
Barcode scanner, transport case, mini Welding Book, 8m fusion cable	790 156 010	-	21.000
Barcode (scanner) and manual mode version	790 160 042	-	15.000



Double clamp with universal link

- Recommended for the installation of fittings ELGEF Plus and ecoFIT d40 - 200 and d160 - 630mm
- Recommended for the installation of fittings COOL-FIT d32/D75 - d140/D200 and d160/D250 - d450/D630
- The clamping allows installation without tension and avoids movement during fusion and cooling time
- The centrally located adjustable universal link allows installation of electrofusion couplers, elbows and reducers
- Works above, below and alongside the joint
- Adaptor for use with Tee-pieces available (see accessories)

d (mm)	d1 (inch)	Code GF	Code Reece	Weight (kg)	Description	L (mm)	B (mm)	H (mm)
40	200	799 301 490	1470281	4.200	Scope of delivery: 2 x Straight bar, 1 x Universal link, Transport bag (600x380x250)	960	290	230
160	630	799 301 496	1470282	14.100	Scope of delivery: 2 x V-block, 2 x Straight bar, 1 x Universal link, Transport bag (780x780x580)	1300	670	550



Quadruple clamp with universal link

- Recommended for the installation of fittings ELGEF Plus and ecoFIT d40 - 200 and d160 - 630mm
- Recommended for the installation of fittings COOL-FIT d32/D75 - d140/D200 and d160/D250 - d450/D630
- The clamping allows installation without tension and avoids movement during fusion and cooling time
- The centrally located adjustable universal link allows installation of electrofusion couplers, elbows and reducers
- Universal use; works above, below and alongside the joint
- Adaptor for use with Tee-pieces available (see accessories)

d (mm)	d1 (inch)	Code GF	Code Reece	Weight (kg)	Description	L (mm)	B (mm)	H (mm)
40	200	799 301 489	1470646	8.300	Scope of delivery: 4 x V-block, 2 x Straight bar, 1 x Universal link, Transport bag (600x380x250)	960	290	230
160	630	799 301 495	1470647	23.300	Scope of delivery: 2 x V-block, 2 x Straight bar, 1 x Universal link, Transport bag (780x780x580)	1300	670	550



Tee adaptor

- Suitable for clamping tool (799301489 - 495)

d (mm)	d1 (inch)	Code GF	Code Reece	Weight (kg)	Description	L (mm)	B (mm)	H (mm)
40	200	799 301 491	-	0.610	Tee adaptor	600	50	40
160	630	799 301 497	-	3.500	Tee adaptor	1070	75	60



V-block

- Suitable for clamping tool (799301489 - 495)

d (mm)	d1 (inch)	Code GF	Code Reece	Weight (kg)	Description	L (mm)	B (mm)	H (mm)
40	200	799 301 492	-	1.000	V-block complete	290	230	65
160	630	799 301 498	-	3.200	V-block complete	660	430	90



Bar extension

- Suitable for clamping tool (799301489 - 495)

d (mm)	d1 (inch)	Code GF	Code Reece	Weight (kg)	Description	L (mm)	B (mm)	H (mm)
160	630	799 301 499	-	1.000	Bar extension	1000	40	40

COOL-FIT 2.0 Spare parts



COOL-FIT 2.0/4.0 Insulation for ball valve type 546 / 542

Model:

- Set consisting of half shells and clamps

Note:

Suitable for COOL-FIT ball valve only

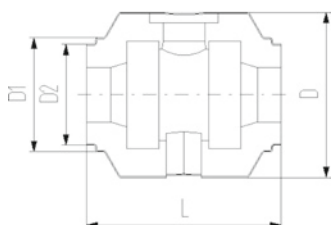

d (mm)	DN (mm)	Code GF	Code Reece	Weight (kg)	D (mm)	L (mm)	D2 (mm)	D1 (mm)
32	25	738 990 308	1470287	0.160	132	152	82	97
40	32	738 990 309	1470288	0.228	157	170	97	117
50	40	738 990 310	1470289	0.282	169	184	97	117
63	50	738 990 311	1470290	0.498	204	227	117	132
75	65	738 990 312	1470291	0.935	235	276	132	147
90	80	738 990 313	1470292	1.033	255	297	147	168



COOL-FIT 2.0/4.0 Insulation for butterfly valve type 567

Model:

- Set consisting of half shells and clamps

Note:

Suitable for COOL-FIT butterfly valve only

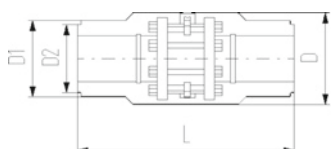

d (mm)	DN (mm)	Code GF	Code Reece	Weight (kg)	D (mm)	D1 (mm)	D2 (mm)	L (mm)
110	100	738 990 324	1470293	2.054	310	188	168	556
140	125	738 990 326	1470294	2.947	287	233	208	662



COOL-FIT 2.0/4.0 Insulation for flange adaptor

Model:

- Set consisting of half shells and clamps

Note:

Suitable for COOL-FIT flange adaptor only

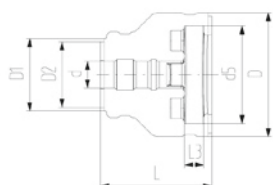

d (mm)	DN (mm)	Code GF	Code Reece	Weight (kg)	D (mm)	D1 (mm)	D2 (mm)	L (mm)	L3 (mm)	d5 (mm)
32	25	738 990 458	-	0.226	135	90	75	162	26	121
40	32	738 990 459	-	0.331	170	110	90	165	28	146
50	40	738 990 460	-	0.386	180	110	90	178	30	156
63	50	738 990 461	-	0.533	200	125	110	230	32	171
75	65	738 990 462	-	0.674	220	140	125	232	34	191
90	80	738 990 463	-	0.754	240	160	140	245	35	206
110	100	738 990 464	-	0.889	270	180	160	254	36	235
140	125	738 990 466	-	1.138	300	225	200	299	38	256



COOL-FIT 2.0 Insulation for welding indicator

Model:

- Sales unit: Bag with 20 pieces

Code GF	Code Reece	Weight (kg)
738 010 051	1470070	0.055



Peeling blade d32-d90

- Suitable for COOL-FIT 2.0/4.0 foam removal and peeling tool (799 738 001)

d (mm)	Code GF	Code Reece	Weight (kg)
32	799 738 101	-	0.015
40	799 738 102	-	0.020
50	799 738 103	-	0.019
63	799 738 104	-	0.020
75	799 738 105	-	0.020
90	799 738 106	-	0.030



Peeling blade d110-d225

- Suitable for COOL-FIT 2.0/4.0 foam removal and peeling tool (799 738 003)

d (mm)	Code GF	Code Reece	Weight (kg)
110	799 738 107	-	0.100
140	799 738 108	-	0.100
160	799 738 109	-	0.100
225	799 738 110	-	0.100



O-Ring for clamping shoe

- Suitable for COOL-FIT 2.0/4.0 foam removal and peeling tool (799 738 001 and 799 738 003)

d (mm)	Code GF	Code Reece	Weight (kg)
32	799 738 050	-	0.003
110	799 738 051	-	0.010



Clamping shoe d32-d90

- Suitable for COOL-FIT 2.0/4.0 foam removal and peeling tool (799 738 001)

d (mm)	Code GF	Code Reece	Weight (kg)	Color
32	799 738 020	-	0.240	silver
40	799 738 021	-	0.090	red
50	799 738 022	-	0.210	anthracite
63	799 738 023	-	0.120	gold
75	799 738 024	-	0.270	blue
90	799 738 025	-	0.480	black



Clamping shoe d110-d225

- Suitable for COOL-FIT 2.0/4.0 foam removal and peeling tool (799 738 003)
- Type A: Spindle start
- Type B: With pipe stop

d (mm)	Code GF	Code Reece	Weight (kg)	Color	Type
110	799 738 026	-	0.680	silver	-
140	799 738 027	-	0.480	red	A
140	799 738 037	-	0.480	red	B
160	799 738 028	-	0.580	anthracite	A
160	799 738 038	-	0.580	anthracite	B
225	799 738 029	-	0.600	gold	A
225	799 738 039	-	0.600	gold	B



Circular blade

- Suitable for COOL-FIT 2.0/4.0 foam removal and peeling tool (799 738 001 and 799 738 003)

Code GF	Code Reece	Weight (kg)
799 738 040	-	0.008



Saw

- Suitable for COOL-FIT 2.0/4.0 foam removal and peeling tool (799 738 003)

d (mm)	Code GF	Code Reece	Weight (kg)
140 - 225	799 738 060	-	1.000



Saw blade

- Suitable for COOL-FIT 2.0/4.0 foam removal and peeling tool (799 738 003)

d (mm)	Code GF	Code Reece	Weight (kg)
140 - 225	799 738 061	-	0.029

Notes

Located where you need us

Company Details

Legal name: George Fischer Pty. Ltd.

ABN: 37 001 686 399

Website: www.gfps.com/au

Contact Details

Phone no.: 1300 130 149

Email: aus_customerservice@georgfischer.com

Locations Australia

Sydney

Head Office / Warehouse / Workshop

Address: Unit 1, 100 Belmore Road North Riverwood, NSW 2210

Brisbane

Sales Office / Warehouse / Workshop

Address: 18 Kingsbury Street Brendale, QLD 4500

Melbourne

Sales Office

Address: Unit 29, 125 Rooks Road Nunawading, VIC 3131

Perth

Sales Office / Warehouse

Address: 13 Weedon Road Forrestdale, WA 6112

Locations New Zealand

Wellington

Sales Office / Warehouse

Address: PO Box 40399, Upper Hutt 5140, 13 Jupiter Road

Tel: +64 4 527 9813

The information and technical data (altogether "Data") herein are not binding, unless explicitly confirmed in writing. The Data neither constitutes any expressed, implied or warranted characteristics, nor guaranteed properties or a guaranteed durability. All Data is subject to modification. The General Terms and Conditions of Sale of Georg Fischer Piping Systems apply.

AU_GFDO_6221_4e (05.21)
© Georg Fischer Piping Systems Ltd
8201 Schaffhausen/Switzerland, 2021



Available at

ACTROL™

reece

hvac