

AXA

H10 COUNTER BASINS

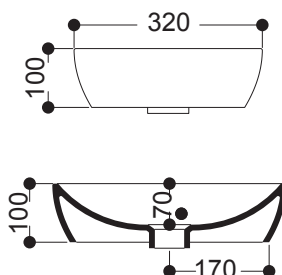

H10 Rectangle Above Counter Basin 400 x 320mm

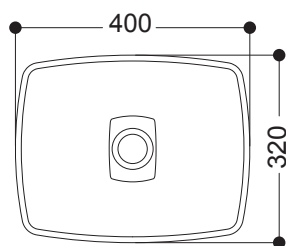
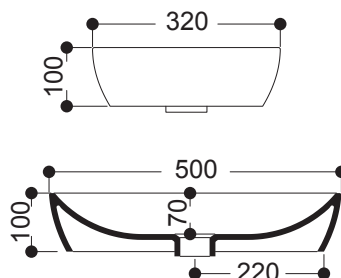
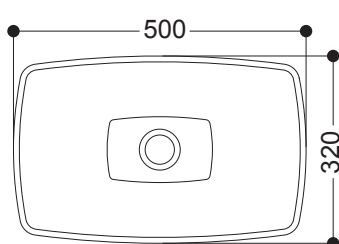

H10 Rectangle Above Counter Basin 500 x 320mm

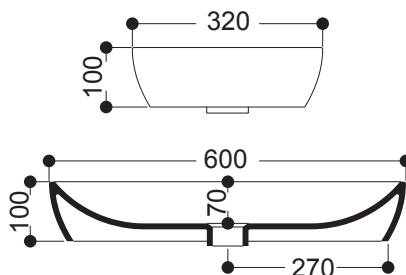
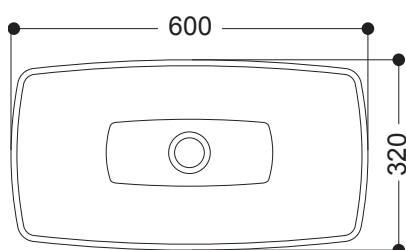

H10 Rectangle Above Counter Basin 600 x 320mm



To see the complete Axa range go to www.reece.com.au/bathrooms

SPECIFICATIONS

Recommended use	Domestic, hotel and commercial
Material	Vitreous china
Colour	White
Integral overflow	No
Taphole availability	No
Basin Capacity	Rectangle Above Counter 400 x 320mm - 5 Litres Rectangle Above Counter 500 x 320mm - 6 Litres Rectangle Above Counter 600 x 320mm - 7 Litres
Weight	Rectangle Above Counter 400 x 320mm - 7.5kg Rectangle Above Counter 500 x 320mm - 9kg Rectangle Above Counter 600 x 320mm - 10kg
Plug and waste	32 x 40mm non-overflow style waste (not supplied)
Fixing	Sealed to countertop with waterproof sealant

Disclaimer: Products in this specification manual must by regulation be installed by licensed and registered trade people. The manufacturer/distributor reserves the right to vary specifications or delete models from their range without prior notification. Dimensions are nominal measurements only. Dimensions and set-outs listed are correct at time of publication however the manufacturer/distributor takes no responsibility for printing errors.

Tech Page Version 1

AXA

H10 COUNTER BASINS

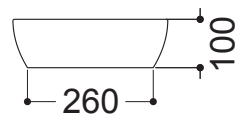
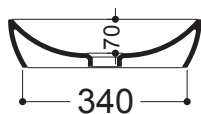
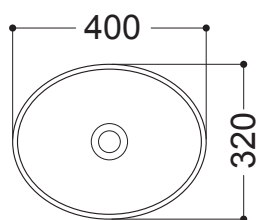

H10 Oval Above Counter Basin 400 x 320mm

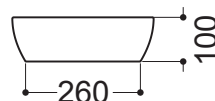
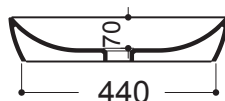
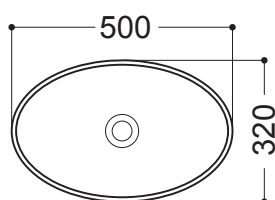

H10 Oval Above Counter Basin 500 x 320mm

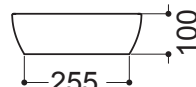
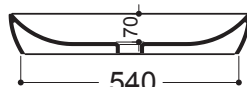
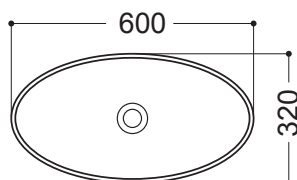

H10 Oval Above Counter Basin 600 x 320mm

SPECIFICATIONS

Recommended use	Domestic, hotel and commercial
Material	Vitreous china
Colour	White
Integral overflow	No
Taphole availability	No
Basin Capacity	Oval Above Counter 400 x 320mm - 4 Litres Oval Above Counter 500 x 320mm - 5 Litres Oval Above Counter 600 x 320mm - 6 Litres
Weight	Oval Above Counter 400 x 320mm - 6 kg Oval Above Counter 500 x 320mm - 8 kg Oval Above Counter 600 x 320mm - 9 kg
Plug and waste	32 x 40mm non-overflow style waste (not supplied)
Fixing	Sealed to countertop with waterproof sealant

To see the complete Axa range go to www.reece.com.au/bathrooms

Plumbers, please ensure a copy of the installation instructions is left with the end user for future reference

AXA

H10 COUNTER BASINS

CLEANING RECOMMENDATIONS

We recommend the use of soapy water or approved cleaners.

This product should not be cleaned with abrasive materials.

Damage caused by any improper treatment is not covered by the product warranty - refer to Warranty Conditions on the last page.

INSTALLATION INSTRUCTIONS

NOTE:

- **If wall mounted tapware is to be used, consideration should be made to length of outlet and positioning of basin on bench top.**
- **If tapware is to be bench mounted allow suitable bench top width for fitting tapware.**

1. Cut hole in bench top to 100mm diameter.
2. Fit selected waste to basin. Ensure waste is sealed top and bottom.
3. Apply waterproof sealant (not supplied) to the rim of the basin and to the bench top.
4. Fit basin onto the bench top and press firmly all around to achieve good seal.
5. Remove surplus sealant.

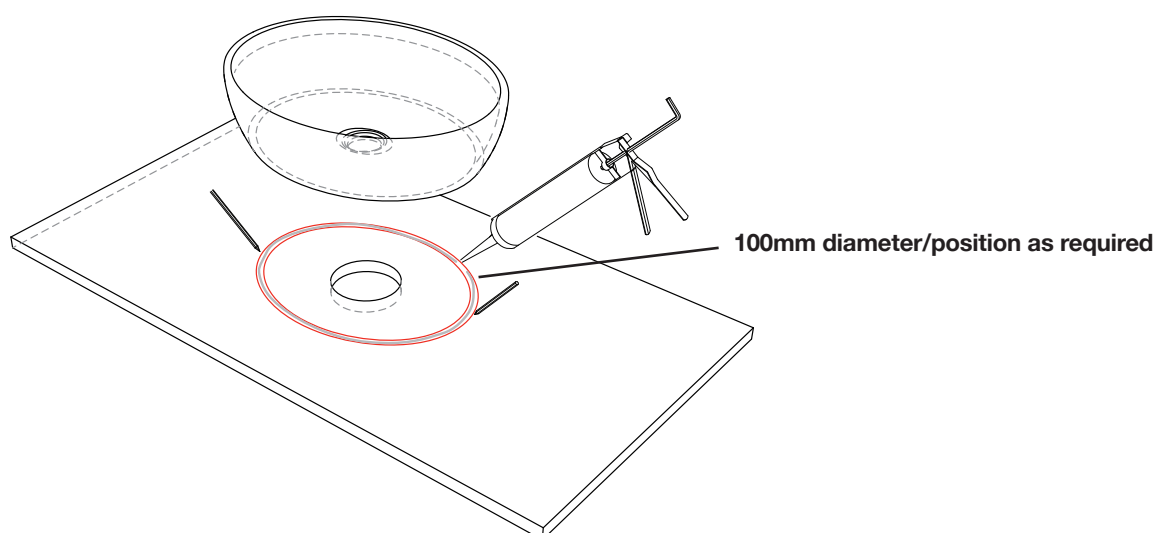

NOTE: The shape of the basin is purely indicative.

AXA

H10 COUNTER BASINS



REECE PRODUCT QUALITY GUARANTEE

You have purchased a quality product from Reece Pty Ltd ABN 84 004 097 090 ("Reece"). This product is covered by a 15 year replacement product warranty and a 12 month warranty over spare parts and labour.

15 YEAR WARRANTY – DOMESTIC USE

This warranty covers faults in the product construction, material and assembly. Products which are within 15 years from the date of purchase, found upon inspection by an authorised Reece representative, to be defective in construction, material or assembly, will be repaired or exchanged with an equivalent product free of charge. Replaced items become Reece's property.

All replacement products will be available for collection without charge to the customer at the nearest Reece branch to the customer's location, or elsewhere as agreed between the customer and Reece.

Labour and Spare Parts

The labour for the replacement of products and spare parts to which this warranty applies will be supplied by Reece or relevant supplier using licensed plumbers engaged by Reece or relevant supplier within 1 year from the date of purchase.

Spare parts which are within 1 year from the date of purchase found upon inspection by an authorised Reece representative to be defective in construction, material or assembly, will be replaced free of charge.

Warranty Conditions

This warranty will apply only under all of the following conditions:

- The item has been installed by a licensed plumber
- The item has been installed for and subjected to domestic residential use only
- Failure is due to a fault in the manufacture of the product
- Proof of purchase (including the date of purchase) is provided
- The installation of the product is in accordance with the instructions provided

This warranty does not cover products purchased as an ex-display without being fully checked and tested for sale by the manufacturer.

This warranty does not include faults caused by:

- Unsuitable or improper use
- Incorrect installation or installation not in accordance with the instructions provided
- Installation or part installation by the purchaser or any person other than a LICENSED PLUMBER
- Normal wear and tear
- Inadequate or complete lack of maintenance
- Chemical, electrochemical or electrical influences
- Harsh detergents or abrasive cleaners used on product finishes

1 YEAR WARRANTY – COMMERCIAL USE

'Commercial' use is all use other than for normal domestic residential purposes, including use in non-business places as in public buildings, schools, sports centres and in establishments that contain private bathrooms with high frequency of use by many individuals, such as hotels, motels, retirement villages and hospitals.

The Commercial warranty covers this product against manufacturing faults in the construction, material and assembly of both the finished products and any spare parts for a period of 1 year from the date of purchase. Products and spare parts which are found upon inspection by an authorised Reece representative to be defective in construction, material or assembly will be repaired or exchanged free of charge. Replaced items become Reece's property. The labour for the replacement of products and spare parts to which this warranty applies will be supplied by Reece or relevant supplier using licensed plumbers engaged by Reece or relevant supplier. The Warranty Conditions and exclusions which apply to the domestic use warranty also apply to this commercial warranty.

EXCLUSIONS

To the fullest extent permitted by law, Reece excludes all liability for damage or injury to any person, damage to any property, and any indirect consequential or other loss or damage.

CLAIM PROCEDURE

For all warranty queries customers are to contact the branch where the product was purchased. These details can be found on your purchase invoice.

Our goods come with guarantees that cannot be excluded under the Australian Consumer Law. You are entitled to a replacement or refund for a major failure and for compensation for any other reasonably foreseeable loss or damage. You are also entitled to have the goods repaired or replaced if the goods fail to be of acceptable quality and the failure does not amount to a major failure.