



WOLFEN

INSTALLATION MANUAL

9508010 Wolfen 800 CCBTW Toilet Suite White (4 Star)

9508011 Wolfen 800 CCBTW Toilet Suite Blue (4 Star)

9508012 Wolfen 800 CCBTW Toilet Suite Grey (4 Star)

9508924 Wolfen 800 CCBTW Toilet Suite with Backrest White (4 Star)

9508925 Wolfen 800 CCBTW Toilet Suite with Backrest Blue (4 Star)

9508926 Wolfen 800 CCBTW Toilet Suite with Backrest Grey (4 Star)



TECHNICAL INFORMATION

Model	Wolfen 800 CCBTW Toilet Suite Single Flap Seat White (4 Star)	Wolfen 800 CCBTW Toilet Suite Single Flap Seat Blue (4 Star)	Wolfen 800 CCBTW Toilet Suite Single Flap Seat Grey (4 Star)
Product Code	9508010	9508011	9508012
Material	Pan - Vitreous China Cistern - Vitreous China Seat - Urea	Pan - Vitreous China Cistern - Vitreous China Seat - Urea	Pan - Vitreous China Cistern - Vitreous China Seat - Urea
Colour	Pan - White Cistern - White Seat - White	Pan - White Cistern - White Seat - Blue	Pan - White Cistern - White Seat - Grey
Weight	Pan 50kg Cistern 19kg Seat 1.1kg	Pan 50kg Cistern 19kg Seat 1.1kg	Pan 50kg Cistern 19kg Seat 1.1kg
Water Inlet Position	Back Inlet	Back Inlet	Back Inlet
Toilet Seat	Single Flap Seat	Single Flap Seat	Single Flap Seat
Rim Configuration	Rimless	Rimless	Rimless
Set Out (mm)	185 min - 285 max	185 min - 285 max	185 min - 285 max
Inlet Valve Pressure	500 kPa	500 kPa	500 kPa
For Replacement Spare Parts	9508007 Wolfen Single Flap Toilet Seat White	9508008 Wolfen Single Flap Toilet Seat Blue	9508009 Wolfen Single Flap Toilet Seat Grey
	9508769 Wolfen 800 Toilet Suite Button - White	9508768 Wolfen 800 Toilet Suite Button - Blue	9508767 Wolfen 800 Toilet Suite Button - Grey
	9508717 Wolfen Seat Buffers (Sideways)		
	9508718 Wolfen Fixing Kit		

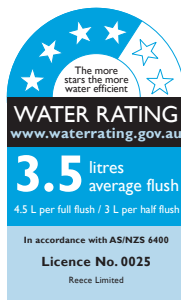

TECHNICAL INFORMATION

Model	Wolfen 800 CCBTW Toilet Suite Single Flap Seat with Backrest White (4 Star)	Wolfen 800 CCBTW Toilet Suite Single Flap Seat with Backrest Blue (4 Star)	Wolfen 800 CCBTW Toilet Suite Single Flap Seat with Backrest Grey (4 Star)
Product Code	9508924	9508925	9508926
Material	Pan - Vitreous China Cistern - Vitreous China Seat - Urea	Pan - Vitreous China Cistern - Vitreous China Seat - Urea	Pan - Vitreous China Cistern - Vitreous China Seat - Urea
Colour	Pan - White Cistern - White Seat - White	Pan - White Cistern - White Seat - Blue	Pan - White Cistern - White Seat - Grey
Weight	Pan 50kg Cistern 19kg Seat 1.1kg	Pan 50kg Cistern 19kg Seat 1.1kg	Pan 50kg Cistern 19kg Seat 1.1kg
Water Inlet Position	Back Inlet	Back Inlet	Back Inlet
Toilet Seat	Single Flap Seat	Single Flap Seat	Single Flap Seat
Rim Configuration	Rimless	Rimless	Rimless
Set Out (mm)	185 min - 285 max	185 min - 285 max	185 min - 285 max
Inlet Valve Pressure	500 kPa	500 kPa	500 kPa
For Replacement Spare Parts	9508007 Wolfen Single Flap Toilet Seat White	9508008 Wolfen Single Flap Toilet Seat Blue	9508009 Wolfen Single Flap Toilet Seat Grey
	9508769 Wolfen 800 Toilet Suite Button - White	9508768 Wolfen 800 Toilet Suite Button - Blue	9508767 Wolfen 800 Toilet Suite Button - Grey
	9508717 Wolfen Seat Buffers (Sideways)		
	9508718 Wolfen Fixing Kit		
	9507171 Wolfen Back Rest with Fixed Armst		

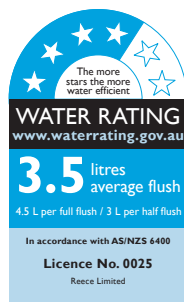

Model	Wolfen Back Rest with Fixed Arms
Product Code	9507171
Colour	Stainless Steel Arms White Back Rest
Finish	Brushed Arms
Material	304 Grade Stainless Steel Arms UV stabilised HDPE Back Rest 316 Grade Stainless Steel Coach Screws

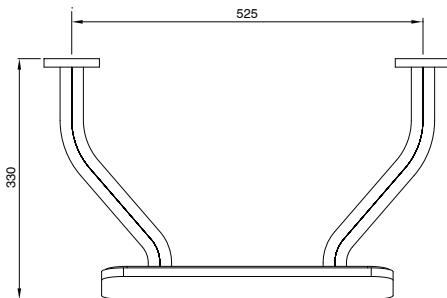
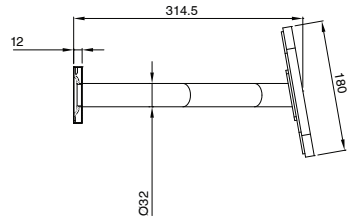
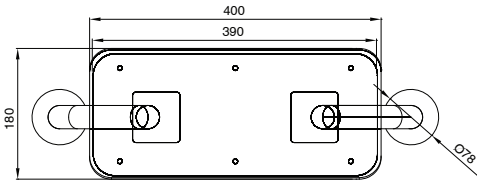

INSTALLATION INSTRUCTIONS

Wolfen CCBTW Toilet Suite Single Flap Seat (4 Star)

9508010 | 9508011 | 9508012

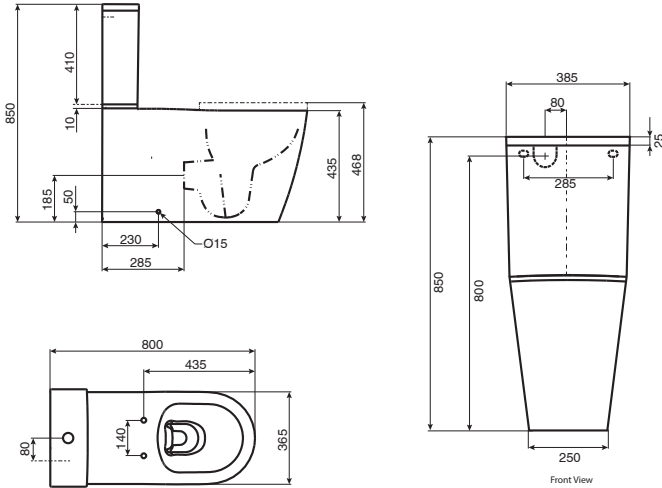

Wolfen CCBTW Toilet Suite Single Flap Seat with Backrest (4 Star)

9508924 | 9508925 | 9508926

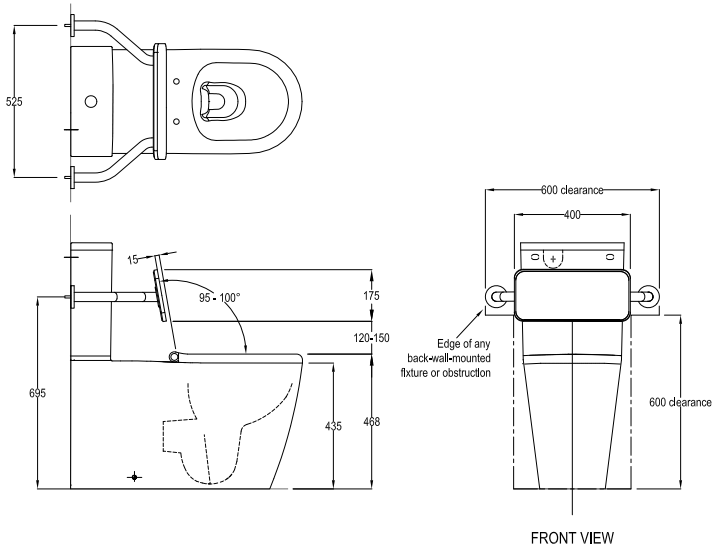

Set-Up

1. Rough in positions of water inlet, waste outlet and fixing bracket holes. Ensure inlet connection extends 40mm from finished wall. Prepare waste outlet according to required set out (185mm min - 285mm max) and drill floor fixing brackets into position (60mm inside traced mark of pan rim).
2. Insert top-fix plastic fixing nut (2) and bolt (2) into pan (supplied) to fit the cistern.

S-Trap Installation

1. Lubricate the rubber fins of the pan bend and position in the waste pipe at the required height. Fix the pan connector back to the wall using the rod and bracket.
2. Align and push pan back to wall, connect pan spigot into waste bend ensuring firm connection.
3. Fix cistern onto pan, bucket flush and check for leaks.

Water Inlet & Levelling Pan

1. Connect rear water inlet valve using 15mm mini cistern stop supplied. Fit hose elbow to mini cistern stop. Fill the cistern and ensure correct water level. For adjustment refer separate inlet valve instructions,
2. Ensure that pan is level and that cistern aligns with wall. Make minor adjustments if necessary.
3. Fix pan to floor using screws and caps provided
4. Silicone pan to floor. Remove excess sealant.

Important Note

Ensure that the back inlet connection extends 40mm from the finished wall.

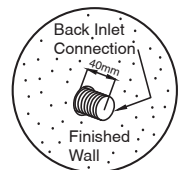

CLEANING

We recommend the use of soap water or approved cleaners. This product should not be cleaned with abrasive materials. Damage caused by any improper treatment is not covered by the product warranty. Refer to Warranty Conditions.

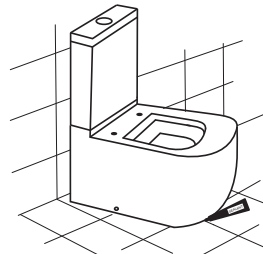
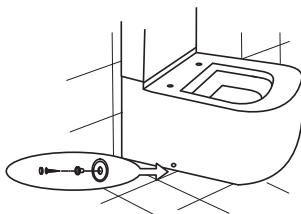
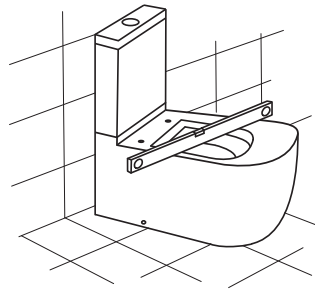
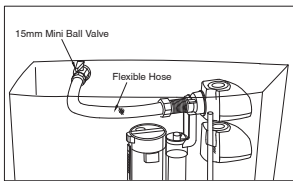
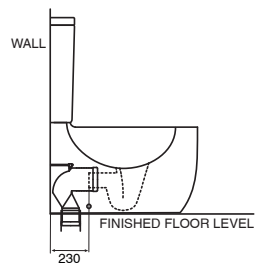
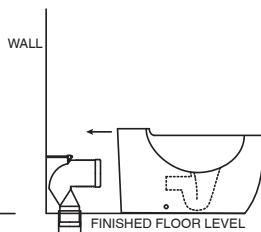
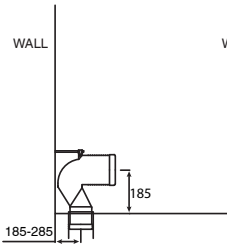
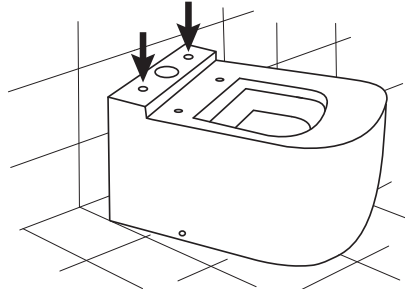
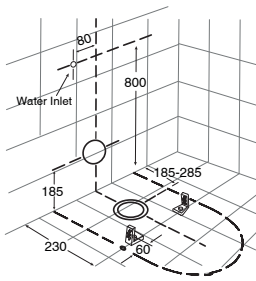

INSTALLATION INSTRUCTIONS

Wolfen Back Rest with Fixed Arms

9507171

Important Note

The Wolfen back rest should be properly assembled, installed and cared for. Failure to follow the below instructions may result in serious injury.

The back rest bar meets AS 1428.1-2009 and is manufactured from high quality stainless steel with a HDPE back rest. It has been tested to a loading of 1100N. Proper care must be taken to install the grab bar to an appropriate load bearing base, using appropriate fixing bolts.

Installation Instructions

1. Confirm the contents of the box, The box should contain 1 back rest and 6 screws.

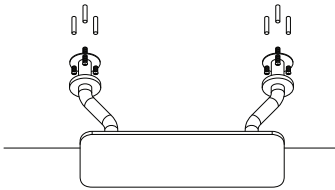

2. Assemble the two legs to the stainless panel.

Ensure that the wall the back rest is to be mounted to contains sufficient timber to provide proper structural support.

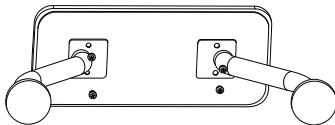

IMPORTANT INSTALLATION NOTE:

Where there is an inwall cistern installed, take care to ensure that no screws are drilled into the concealed cistern.

3. Using the mounting flange plates as a template, mark the centre of the screw hole locations and drill the holes.

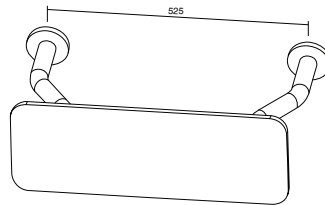

4. Install the back rest with the screws provided. Inspect each screw to ensure it is screwed in fully.

5. Twist the flanges onto the mounting flange plates.

Maintenance

Clean product with mild soap and water.

REECE PRODUCT QUALITY GUARANTEE



You have purchased a quality product from Reece Australia Pty Ltd ABN 84 004 097 090 ("Reece"). This product is covered by a 5 year replacement product warranty and a 12 month warranty over spare parts and labour.

5 YEAR WARRANTY

This warranty covers faults in the product construction, material and assembly. Products which are within 5 years from the date of purchase, found upon inspection by an authorised Reece representative, to be defective in construction, material or assembly, will be repaired or exchanged with an equivalent product free of charge. Replaced items become Reece's property.

All replacement products will be available for collection without charge to the customer at the nearest Reece branch to the customer's location, or elsewhere as agreed between the customer and Reece.

Labour and Spare Parts

The labour for the replacement of products and spare parts to which this warranty applies will be supplied by Reece or relevant supplier using licensed plumbers engaged by Reece or relevant supplier within 1 year from the date of purchase. Spare parts other than those listed in the Manufacturer's Provisions above, which are within 1 year from the date of purchase found upon inspection by an authorised Reece representative to be defective in construction, material or assembly, will be replaced free of charge.

Warranty Conditions

This warranty will apply only under all of the following conditions:

- The item has been installed by a licensed plumber
- Failure is due to a fault in the manufacture of the product
- Proof of purchase (including the date of purchase) is provided
- The installation of the product is in accordance with the instructions provided

This warranty does not cover products purchased as an ex-display without being fully checked and tested for sale by the manufacturer.

This warranty does not include faults caused by:

- Unsuitable or improper use
- Incorrect installation or installation not in accordance with the instructions provided
- Installation or part installation by the purchaser or any person other than a LICENSED PLUMBER
- Normal wear and tear
- Inadequate or complete lack of maintenance
- Chemical, electrochemical or electrical influences
- Harsh detergents or abrasive cleaners used on product finishes

EXCLUSIONS

To the fullest extent permitted by law, Reece excludes all liability for damage or injury to any person, damage to any property, and any indirect consequential or other loss or damage.

CLAIM PROCEDURE

For all warranty queries customers are to contact the branch where the product was purchased. These details can be found on your purchase invoice.

Our goods come with guarantees that cannot be excluded under the Australian Consumer Law. You are entitled to a replacement or refund for a major failure and for compensation for any other reasonably foreseeable loss or damage. You are also entitled to have the goods repaired or replaced if the goods fail to be of acceptable quality and the failure does not amount to a major failure.

IF AFTER CHECKING THE
INSTALLATION INSTRUCTIONS
AND IMPORTANT
INFORMATION, THE PROBLEM
HAS NOT BEEN IDENTIFIED,
CUSTOMERS ARE TO
CONTACT THE BRANCH
WHERE THE PRODUCT WAS
PURCHASED. THESE DETAILS
CAN BE FOUND ON YOUR
PURCHASE INVOICE.

General contact details for
Reece are as follows:

Reece Australia Pty Ltd

118 Burwood Hwy

Burwood VIC 3125

+61 3 9274 0000

admin@reece.com.au



WOLFEN™

reece.com.au/wolfen