

Posh Bristol MK2 Vanity with Kickboard 1200mm

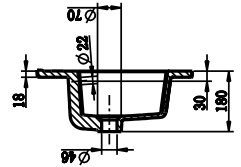
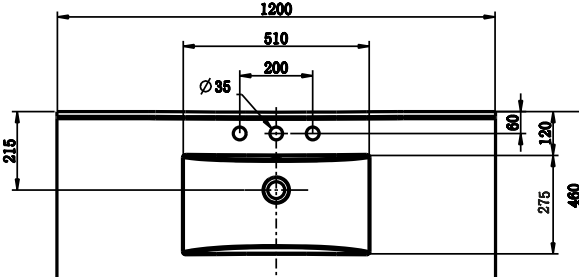
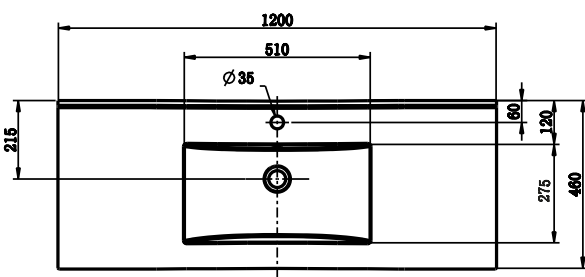

SPECIFICATIONS

Recommended use	Domestic, hotel, and commercial
Basin material	Vitreous china
Cabinet material	MDF (2 Pac polyurethane)
Colour availability	White
Taphole option	1 or 3 Taphole
Capacity	6 Litres
Integrated overflow	Yes
Plug and waste	32x40mm with overflow (not supplied)
Fixing	Top siliconed to cabinet, cabinet screwed back to wall

To see the complete Posh range go to www.reece.com.au/bathrooms

CLEANING RECOMMENDATIONS

We recommend the use of soapy water or approved cleaners.

This product should not be cleaned with abrasive materials.

Damage caused by any improper treatment is not covered by the product warranty- refer to Warranty Conditions.

Posh Bristol MK2 Vanity with Kickboard 1200mm

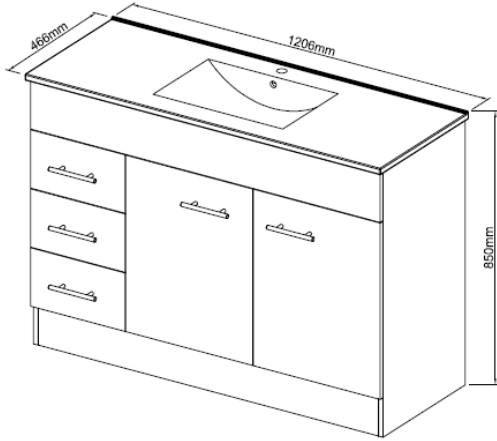

Freestanding Vanity 1200mm (Left Hand Drawer)

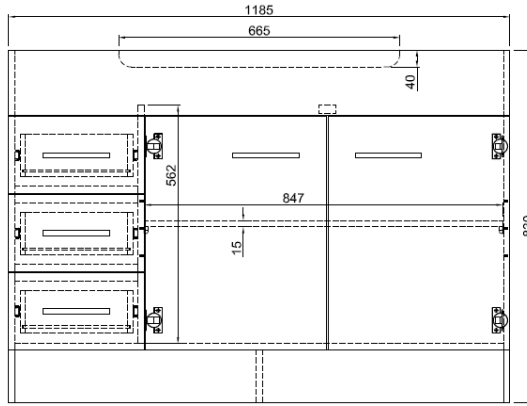

Cabinet Only - Front View

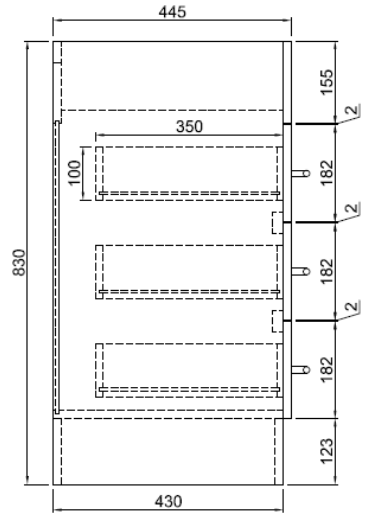

Cabinet Only - Side View

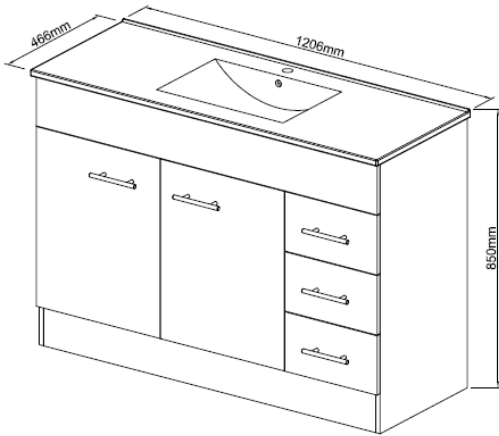

Freestanding Vanity 1200mm (Right Hand Drawer)

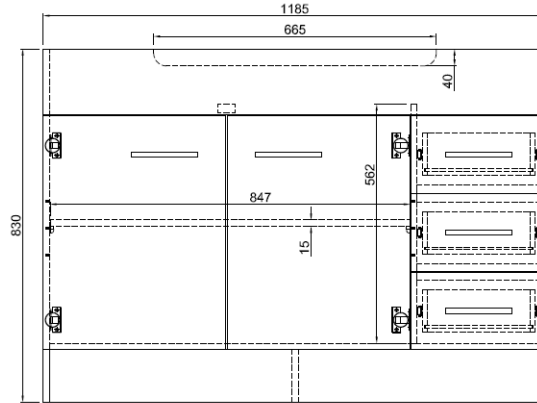

Cabinet Only - Front View

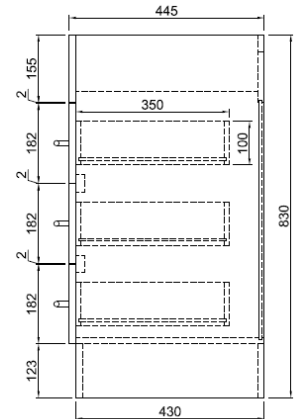

Cabinet Only - Side View

Dimensions are nominal measurements only.

Disclaimer: Products in this specification manual must by regulation be installed by licensed and registered trade people. The manufacturer/distributor reserves the right to vary specifications or delete models from their range without prior notification. Dimensions are nominal measurements only. Dimensions and set-outs listed are correct at time of publication however the manufacturer distributor takes no responsibility for printing errors.

Posh Bristol MK2 Vanity with Kickboard 1200mm

NOTE

Vanity unit must be installed by a qualified tradesman.

IMPORTANT

If fixing to timber framed walls or partitioning, care should be taken to properly reinforce wall.

Please check vanity unit for damage before installing. If there is damage, please notify Reece branch where the product was purchased to organise a replacement product. Installation of the vanity unit is deemed as accepting the condition of the vanity unit.

Freestanding Vanity Installation Procedure

1. Ensure that wall is plumb and floor is level.
2. Set up water inlet point and waste.
3. Place vanity unit into position and secure to wall. Make minor adjustments to hanging clips and then fully tighten coach screws.
4. External edges where the unit meets the wall should be sealed using flexible sealant.

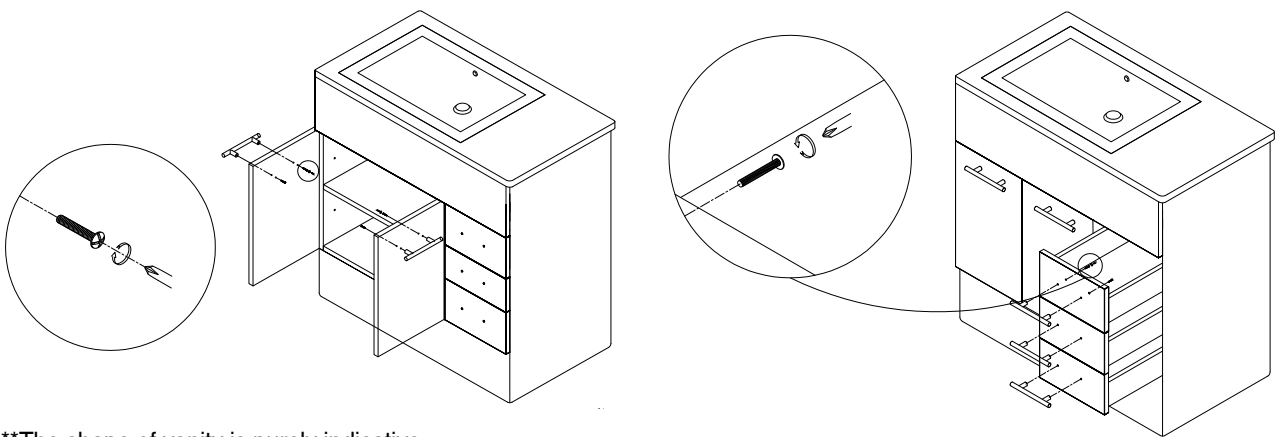

**The shape of vanity is purely indicative.