

---

# RANGE BROCHURE

---













RENOVATION  
NEEDS  
INSPIRATION



**PANEL RADIATORS**

	Compact	4
	Plan Compact	8
	Vertical	11
	Banga	13

**DESIGN RADIATORS**

	Delta Column	14
	Kos V	18
	Kos H	20
	Tinos	22
	Leros	24

**COLOUR OPTIONS**

26



## COMPACT

type 11, 21



### type 11

ORDER CODE : C11XXXXYYY  
 EXAMPLE : C116001200  
 radiator  
 type  
 height  
 length

### type 21

ORDER CODE : C21XXXXYYY  
 EXAMPLE : C216001200  
 radiator  
 type  
 height  
 length

Thermal output of radiators in watts (90°C in / 70°C out / 20°C room)

Length	Height							
	C11				C21			
	300	500	600	900	300	500	600	900
400	274	437	513	720	382	582	676	942
500	343	547	642	900	477	728	846	1178
600	412	656	770	1080	572	874	1015	1414
700	480	765	898	1260	668	1019	1184	1649
800	549	874	1026	1440	763	1165	1353	1885
900	617	984	1155	1620	859	1310	1522	2120
1000	686	1093	1283	1800	954	1456	1691	2356
1100	755	1202	1411	1980	1049	1602	1860	2592
1200	823	1312	1540	2160	1145	1747	2029	2827
1400	960	1530	1796	2520	1336	2038	2367	3298
1600	1098	1749	2053	2880	1526	2330	2706	3770
1800	1235	1967	2309	3240	1717	2621	3044	4241
2000	1372	2186	2566	3600	1908	2912	3382	4712
2300	1578	2514	2951	4140	2194	3349	3889	5419
2600	1784	2842	3336	4680	2480	3786	4397	6126
3000	2058	3279	3849	5400	2862	4368	5073	7068

Volume: l/m	1.7	2.7	3.2	4.5	3.4	5.5	6.6	9.0
Weight: kg/m	9.1	15.5	18.7	28.3	14.0	23.5	28.3	42.3

## COMPACT

The Purmo Compact radiator is a stylish, elegant and practical radiator, perfect for domestic or commercial applications. With a 33mm profile and convector fins, it ensures a leading performance, even when installed on low temperature systems.

The product range includes type 11, type 21, type 22 and type 33. With a wide range of heights and lengths available from stock, as well as an extended range on request, it truly is a perfect fit for any room size.

- **Operating pressure:**  
Tested to a pressure of 10.5 bar.  
Working pressure of up to 8 bar.
- **Connections:** 4 x 1/2" BSP.
- **Warranty:** 25 years.

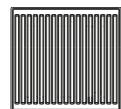

**HEIGHT**  
300, 500, 600, 900mm

**LENGTH**  
400 - 2300mm

**TYPE**  
C11, C21, C22, C33

**FINISH**  
White RAL 9016.  
Other RAL, sanitary and special colours are available upon request. Please note, there is a 40% supplement for non-standard colours. See page 26 for colour options.

Stocked in Australia  
Other sizes available. Lead times will apply.

# COMPACT

## type 22, 33



### type 22

ORDER CODE : C22XXXXYYY  
EXAMPLE : C226001200  
radiator type height length

### type 33

ORDER CODE : C33XXXXYYY  
EXAMPLE : C336001200  
radiator type height length

Thermal output of radiators in watts (90°C in / 70°C out / 20°C room)

Length	Height							
	C22				C33			
	300	500	600	900	300	500	600	900
400	484	743	865	1213	679	1030	1195	1657
500	606	929	1082	1517	849	1288	1494	2072
600	727	1114	1298	1820	1019	1546	1793	2486
700	848	1300	1514	2123	1189	1803	2092	2900
800	969	1486	1730	2426	1358	2061	2390	3314
900	1090	1671	1947	2730	1528	2318	2689	3729
1000	1211	1857	2163	3033	1698	2576	2988	4143
1100	1332	2043	2379	3336	1868	2834	3287	4557
1200	1453	2228	2596	3640	2038	3091	3586	4972
1400	1695	2600	3028	4246	2377	3606	4183	5800
1600	1938	2971	3461	4853	2717	4122	4781	6629
1800	2180	3343	3893	5459	3056	4637	5378	7457
2000	2422	3714	4326	6066	3396	5252	5976	8286
2300	2785	4271	4975	6976	3905	5925	6872	9529
2600	3149	4828	5624	7886	4415	6698	7769	10772
3000	3633	5571	6489	9099	5094	7728	8964	12429

Volume: l/m	3.4	5.5	6.6	9.0	5.1	8.2	9.8	13.3
Weight: kg/m	16.3	27.7	33.4	50.7	24.5	41.6	50.2	75.8

Stocked in Australia  
Other sizes available. Lead times will apply.

# COMPACT

## SIDE VIEW

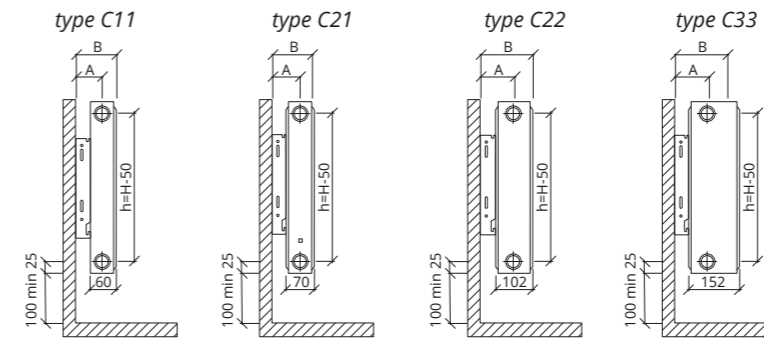

Dimensions based on using the short side on types C11, C21, C22, C33.

	A	B
C11	47	77
C21	52	87
C22	68	119
C23	68	169

## TOP VIEW

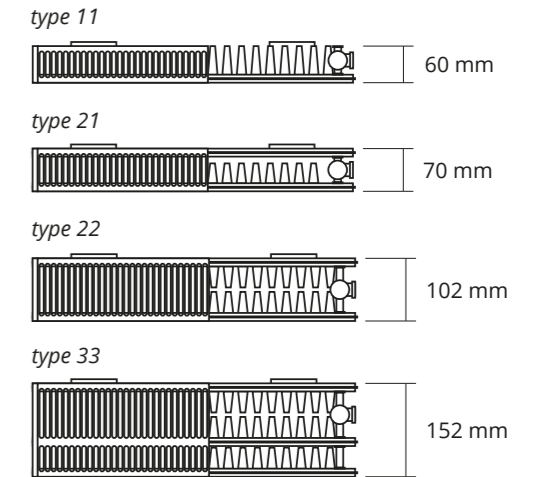

## INSTALLATION

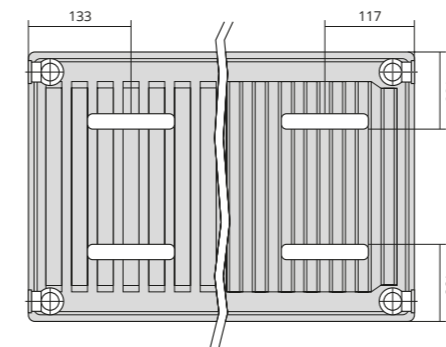

## BRACKETS

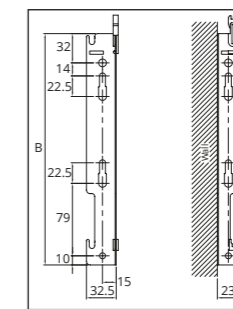

wall bracket types 21 & 22

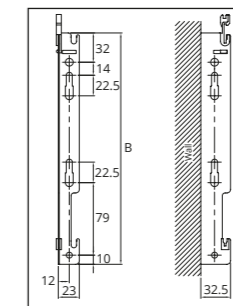
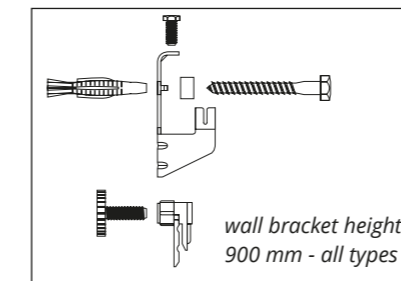

## CONNECTION OPTIONS

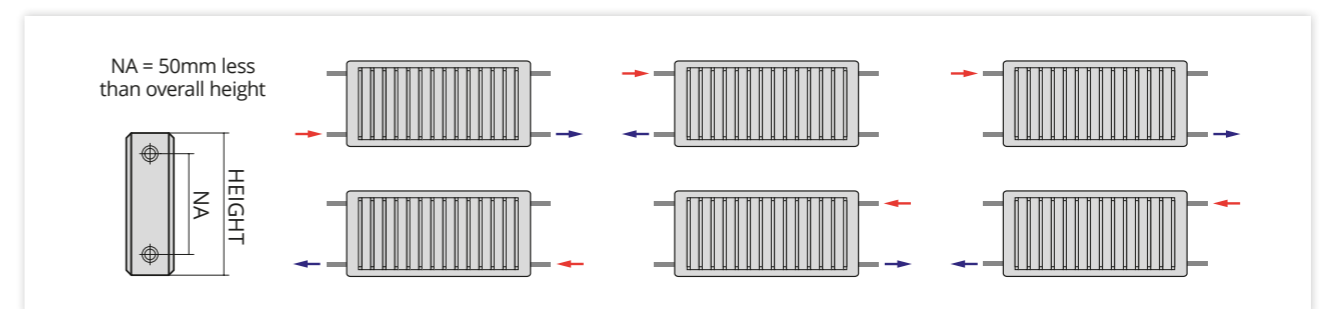



## PLAN COMPACT

The outstanding characteristic of the Plan Compact is its stylish flat front with lucent lamination, which consists of attached top and side panels. These cover the Plan Compact in such a way that no overlapping corners can be seen from the front.

Accessories included in the packaging:  
'L' brackets, 1 air-vent, 1 blank cap, screws and plugs.

- **Operating pressure:**  
Tested to a pressure of 13 bar.  
Working pressure of up to 10 bar.
- **Connections:** 4 x 1/2" BSP.
- **Warranty:** 10 years.



**HEIGHT**  
300, 400, 500, 600mm

**LENGTH**  
400 - 3000mm

**TYPE**  
PC11, PC21, PC22

**FINISH**  
White RAL 9016.

## PLAN COMPACT

type 11, 21, 22



### type 11

ORDER CODE : PC11XXXXYYY  
EXAMPLE : PC116001200

radiator  
type  
height  
length

### type 21

ORDER CODE : PC21XXXXYYY  
EXAMPLE : PC216001200

radiator  
type  
height  
length

### type 12

ORDER CODE : PC22XXXXYYY  
EXAMPLE : PC226001200

radiator  
type  
height  
length

Thermal output of radiators in watts (90°C in / 70°C out / 20°C room)

Length	Height								
	C11				C21	C22			
	300	400	500	600	600	300	400	500	600
400	267	342	414	483	648	472	603	728	844
500	333	428	519	606	811	590	754	909	1055
600	399	514	622	727	973	708	905	1091	1267
700	466	599	725	847	1136	826	1057	1273	1477
800	532	685	829	968	1297	945	1207	1455	1689
900	599	771	933	1089	1460	1062	1385	1638	1900
1000	666	856	1036	1210	1622	1180	1509	1819	2111
1100	733	942	1140	1331	1785	1299	1660	2000	2323
1200	800	1028	1244	1452	1947	1416	1811	2183	2533
1400	933	1199	1451	1694	2271	1653	2113	2547	2955
1600	1065	1370	1659	1937	2596	1888	2414	2910	3379
1800	1199	1542	1866	2179	2920	2125	2716	3274	3801
2000	1333	1713	2073	2421	3245	2361	3018	3638	4223
2300	1533	1970	2385	2784	3732	2715	3471	4184	4857
2600	1732	2227	2969	3148	4219	3069	3924	4730	5491
3000	1999	2570	3110	3632	4868	3541	4528	5458	6335

Volume: l/m	1.50	2.20	2.90	3.40	6.10	3.20	4.20	5.20	6.10
Weight: kg/m	11.70	16.10	20.50	24.80	33.70	19.10	25.10	31.50	38.00

Special order (approximate delivery lead time 12-20 weeks)

TECHNICAL INFORMATION

SIDE VIEW

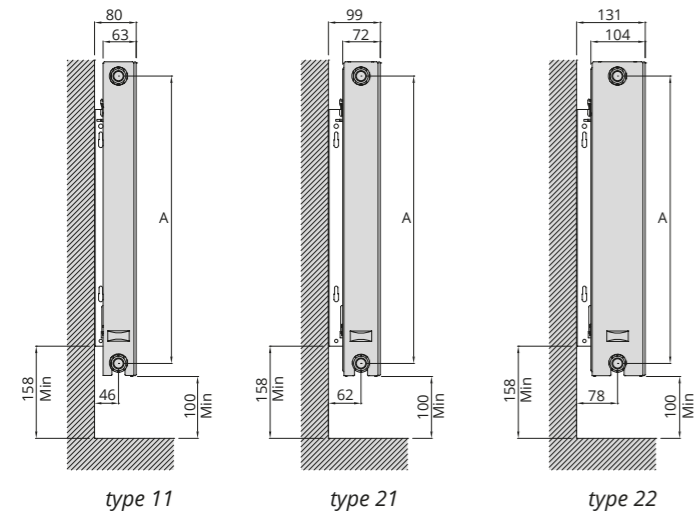

PLAN COMPACT

TOP VIEW

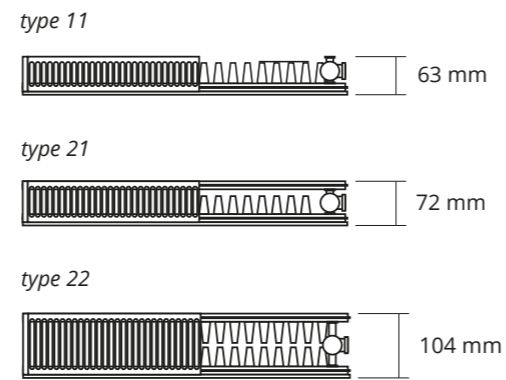

INSTALLATION

types 21, 22

type 11

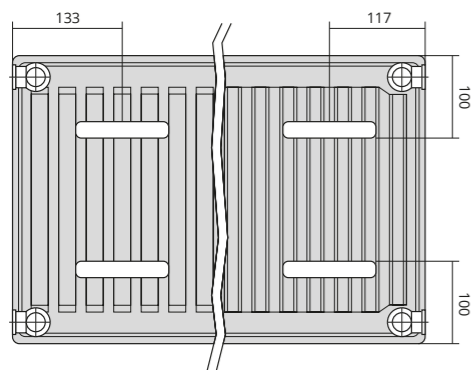

BRACKETS

wall bracket type 11

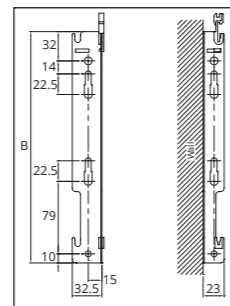

wall bracket types 21 & 22

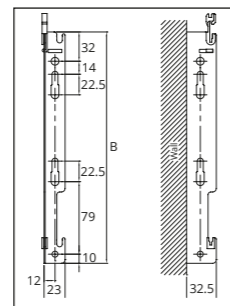

CONNECTION OPTIONS

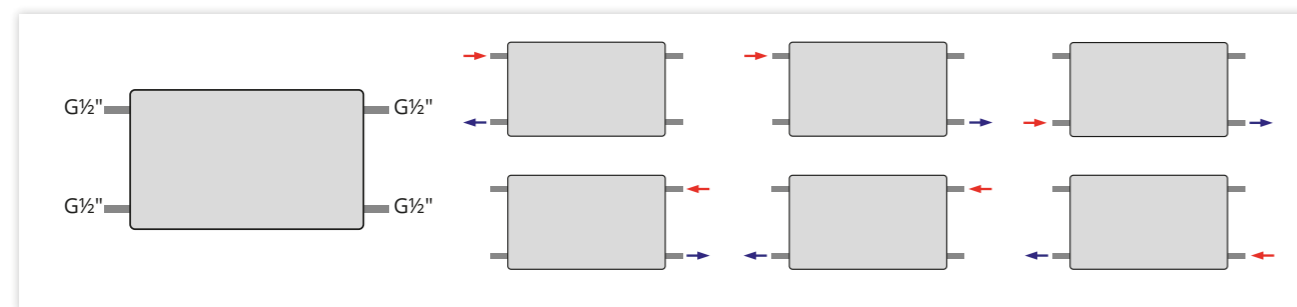

VERTICAL

Purmo Vertical panel radiators are a vertical variant which can be installed on narrow and tall fragments of walls. The radiators are equipped with convection fins and side covers. They have no top grille.

Accessories included in the packaging: brackets, 2 side covers, installation clips, 1 rotating air vent, 3 blank caps, screws and plugs.

- **Operating pressure:** Tested to a pressure of 8 bar. Working pressure of up to 6 bar.
- **Connections:** 6 x 1/2" BSP.
- **Warranty:** 25 years.

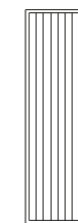

**HEIGHT**  
1800, 1950mm

**WIDTH**  
300, 450, 600, 750mm

**TYPE**  
VR21, VR22

**FINISH**  
White RAL 9016.  
Other RAL, sanitary and special colours are available upon request. Please note, there is a 40% supplement for non-standard colours. See page 26 for colour options.

# VERTICAL

type 21, 22



### type 21

ORDER CODE : VR21SXXXXYYY  
 EXAMPLE : VR21S1800600  
 radiator \_\_\_\_\_  
 type \_\_\_\_\_  
 height \_\_\_\_\_  
 width \_\_\_\_\_

### type 22

ORDER CODE : VR22SXXXXYYY  
 EXAMPLE : VR22S1800600  
 radiator \_\_\_\_\_  
 type \_\_\_\_\_  
 height \_\_\_\_\_  
 width \_\_\_\_\_

Thermal output of radiators in watts (90°C in / 70°C out / 20°C room)

Height				
	Type 21		Type 22	
Length	1800	1950	1800	1950
300	1213	1285	1426	1501
450	1820	1927	2139	2252
600	2426	2570	2852	3003
750	3034	3213	3560	3754

Volume: l/m	21.47	24.13	21.60	23.13
Weight: kg/m	83.07	91.33	93.87	102.33

Special order (approximate delivery lead time 12-20 weeks).

### SIDE VIEW

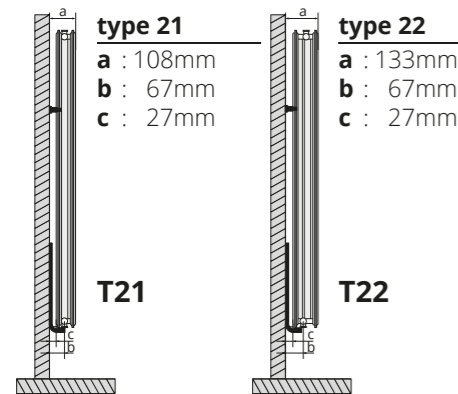

### BRACKETS

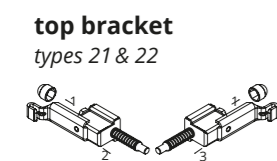

bottom bracket  
types 21 & 22

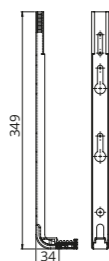

### TOP VIEW

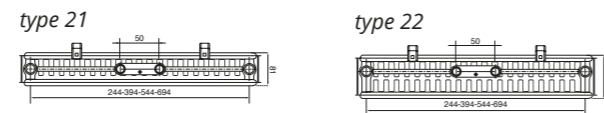

### INSTALLATION

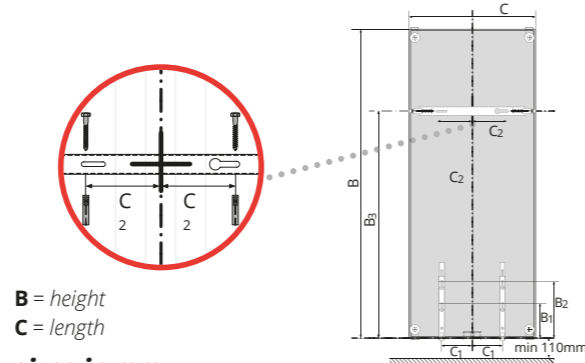

B = height  
C = length

### sizes in mm

	C	300	450	600	750
C <sub>1</sub>	75	100	175	250	
C <sub>2</sub>	50	125	200	275	

	B	1800	1950
B <sub>3</sub>	1450	1600	
B <sub>1</sub>	21-22 = 150		
B <sub>2</sub>	21-22 = 250		

# BANGA

The Purmo Banga radiator is a charming radiator of light and simple design. Perfect for both minimalistic and more traditional interior designs. The adjustable wall bracket and the optimized gaps between the horizontal tube sections facilitate the use of the radiator as a towel dryer.



- **Operating pressure:**  
Tested to a pressure of 8 bar.  
Working pressure of up to 6 bar.
- **Connections:** 4 holes with inner G 1/2".
- **Warranty:** 10 years.

### FRONT VIEW

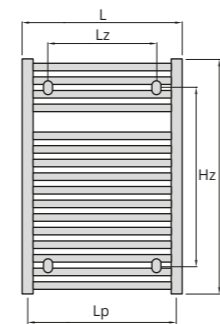

### SIDE VIEW

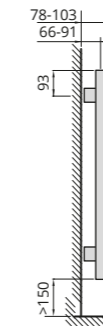

### TOP VIEW

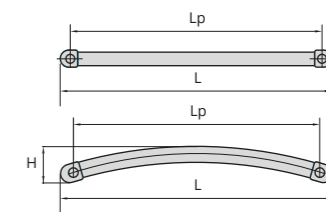

Thermal output of radiators in watts (90°C in / 70°C out / 20°C room)

Type	Power (w) white	Power (w) Chrome	H (mm)	L (mm)	Wall brackets			Lp (mm)	Water Capacity (m3)	Weight (kg)	No. of horizontal tubes
					H (mm)	L (mm)	L (mm) Curved				
BAN 08 05	446	299	862	500	676	350		455	5.6	5.3	15
BAN 08 06	520	348	862	600	676	450	400	555	6.4	6.1	15
BAN 12 05	633	424	1222	500	1036	350		455	7.7	7.3	21
BAN 12 06	740	496	1222	600	1036	450	400	555	8.8	8.4	21
BAN 05 05	785	526	1537	500	1351	350		455	6.6	10.1	26
BAN 15 06	950	637	1537	600	1351	450	400	555	7.8	10.7	26
BAN 18 05	968	649	1807	500	1621	350		455	7.6	11.1	32
BAN 18 06	1142	765	1807	600	1621	450	400	555	9.2	12.4	32

All sizes stocked in Australia.

### TECHNICAL DATA

- Material: high quality steel profiles
- Basic accessories: wall brackets with adjustable distance from wall, 1/2" air bleed
- Maximum working pressure: 8 bar
- Maximum temperature: 100°C
- Colour: white, RAL 9016, chrome



## DELTA COLUMN H

Thermal output of radiators in watts (90°C in / 70°C out / 20°C room)

		Height							
		2 Column		3 Column				4 Column	
Sections	Length	450	600	300	450	600	750	600	750
12	600	549	710		763	984	1200	1256	1529
16	800	732	947	713	1018	1312	1600	1675	2039
20	1000	914	1184	892	1272	1640	2000	2094	2550
24	1200	1097	1421		1527	1968	2400	2512	3060
28	1400	1280	1658	1248	1781	2296	2800	2932	3570
36	1800	1646		1605	2290				

Special order (approximate delivery lead time 12-20 weeks)

## DELTA COLUMN

Fully laser-welded, steel column radiators. Pipe sections and end pieces are welded by laser to columns and blocks. Pipes are smoothed on the outside to obtain the characteristic Delta "D-tubular section". This results in higher heat outputs. Laser welding results in barely visible welded joints.

Accessories included in the packaging: brackets, 1 air vent, 1 radiator plug, screws and plugs.

### Hygiene Certificate

*Delta Column radiators have very low dust emission and are easy to clean. We have been awarded the "The Hygiene Certificate" to demonstrate this. This makes the radiators ideal for use in hospitals, schools etc.*

- **Operating pressure:**  
Tested to a pressure of 13 bar.  
Working pressure of up to 10 bar.
- **Connections:** 4 x ½" BSP.
- **Warranty:** 10 years.

## DELTA COLUMN V

Thermal output of radiators in watts (90°C in / 70°C out / 20°C room)

		Height	
		2 Column	
Sections	Width	2000	
6	300	1110	
8	400	1479	
10	500	1849	
12	600	2691	
15	750	2774	

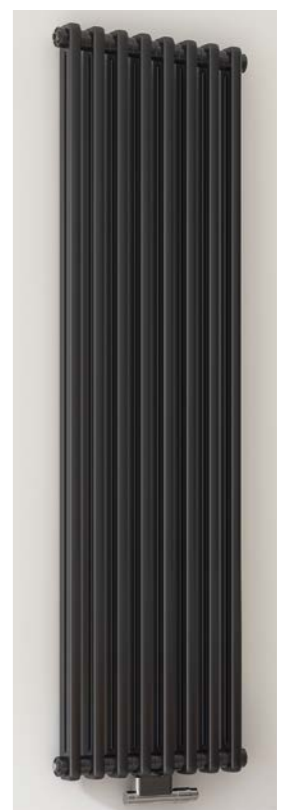

Special order (approximate delivery lead time 12-20 weeks)

**DELTA COLUMN V**

**HEIGHT**    **TYPE**  
2000mm    2 Column

**WIDTH**    **FINISH**  
300, 400, 500, 600, 750mm    White RAL 9016. Other RAL, sanitary and special colours are available upon request. Please note, there is a 40% supplement for non-standard colours. See page 26 for colour options.

**DELTA COLUMN V**

**HEIGHT**    **TYPE**  
300, 450, 600, 750mm    2, 3 & 4 Column

**LENGTH**    **FINISH**  
600-1800mm    White RAL 9016. Other RAL, sanitary and special colours are available upon request. Please note, there is a 40% supplement for non-standard colours. See page 26 for colour options.



TECHNICAL INFORMATION

DELTA COLUMN

INSTALLATION - STANDARD BRACKETS (included with every radiator)

Model	Depth (mm)	WA distance from wall (mm)	AA connection distance (mm)
2 column	63	31/41	63/73
3 column	101	31/41	82/92
4 column	139	31/41	101/111

Ensure tight fit here

Angle Wall Bracket

Insert

OPTIONAL EXTRA FLOOR - BRACKET SK

Complete system for free-standing radiators, from 2-4 column up to 1000mm height. Painted to RAL 9016.

Comprises;

- 3mm thick base-plate for fixing to either finished or unfinished floor
- upright support 35 x 10 x 1.5mm, fixing set with adjustable bracket, security fixing, anti-vibration insert
- adjustable bottom support with spacer and security fixing, anti-vibration insert, white plastic end stop for top of upright.

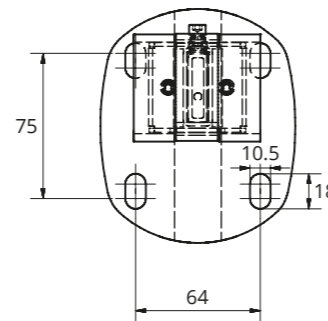
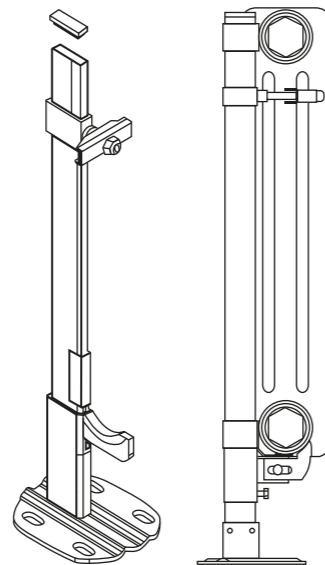

Dimensions of base-plate for Floor Bracket SK

Height of upright	Height of radiator	Order code
460	300	SK20046
610	450	SK20061
760	600	SK20076
910	750	SK20091
Base-plate cover		COVERSKFK

DELTA COLUMN

TECHNICAL INFORMATION (CONT...)

OPTIONAL EXTRA - FLOOR BRACKET FK

Complete system for free-standing radiators, from 2-4 column up to 500mm height. Can also be used in conjunction with supplied wall brackets as extra stability for stud walls. Painted to RAL 9016.

Comprises;

- 3mm thick base-plate fixing for either finished or unfinished floor.

Clamped floor bracket FK	Order code
For 2-4 column rads.	FK1021
Base-plate cover	COVERSKFK

Dimensions of base-plate for Clamped Floor Bracket FK

Two-part cover for base-plate in plastic white RAL 9016 only

For use with 2-4 column radiators

SIDE VIEW

Height	Centre-to-centre
B	A
400	335
500	435
600	535
750	685
900	835

CONNECTION OPTIONS

All Delta Column radiators are manufactured with an internal baffle to help with water flow. The tapping with the baffle is identified with a plastic cap, all others being blue. It is important that the water inlet is connected to tapping identified in red. Column radiators are reversible so any of the following connections are possible:

Connection options for Delta Column V & H

Connection options for Delta Column H only



## KOS V

type 21, 22



### type 21

ORDER CODE : KOV21XXXXYY  
EXAMPLE : KOV211800600

radiator \_\_\_\_\_  
type \_\_\_\_\_  
height \_\_\_\_\_  
width \_\_\_\_\_

### type 22

ORDER CODE : KOV22XXXXYY  
EXAMPLE : KOV221800600

radiator \_\_\_\_\_  
type \_\_\_\_\_  
height \_\_\_\_\_  
width \_\_\_\_\_

Thermal output of radiators in watts (90°C in / 70°C out / 20°C room)

Length	Height			
	Type 21		Type 22	
	1800	1950	1800	1950
300	1116	1179	1317	1389
450	1674	1770	1976	2084
600	2232	2359	2118	2778
750	2790	2949	3294	3472

Volume: l/m	21.47	24.13	21.73	23.47
Weight: kg/m	100.27	109.33	111.6	123.73

Special order (approximate delivery lead time 12-20 weeks)

## KOS V

A compact, minimalist appearance coupled with high heat outputs. The perfect balance between a flat front panel and curved side covers.

Accessories included in the packaging: brackets, 2 side covers, installation clips, 1 rotating air vent, 3 radiator plugs, screws and plugs.

- **Operating pressure:** Tested to a pressure of 8 bar. Working pressure of up to 6 bar.
- **Connections:** 6 x 1/2" BSP. See page 28 for connection options.
- **Warranty:** 10 years.

	<b>HEIGHT</b>	1800, 1950mm
	<b>LENGTH</b>	300, 450, 600, 750mm
	<b>TYPE</b>	KOV21, 22
	<b>FINISH</b>	White RAL 9016. Other RAL, sanitary and special colours are available upon request. Please note, there is a 40% supplement for non-standard colours. See page 26 for colour options.

### SIDE VIEW

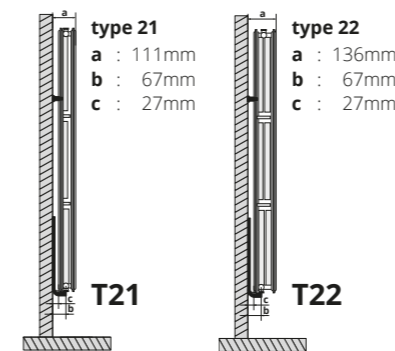

### TOP VIEW

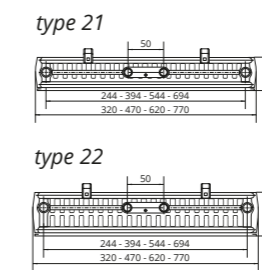

### INSTALLATION

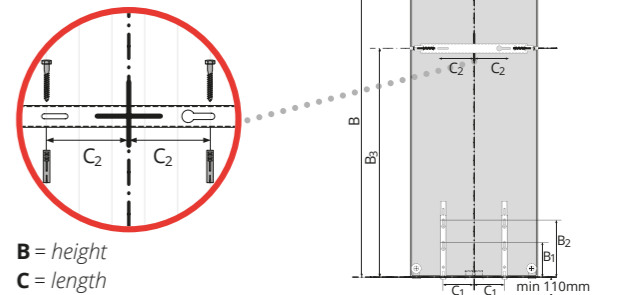

### sizes in mm

<b>C</b>	300	450	600	750
<b>C<sub>1</sub></b>	75	100	175	250
<b>C<sub>2</sub></b>	50	125	200	275

<b>B</b>	1800	1950
<b>B<sub>3</sub></b>	1450	1600
<b>B<sub>1</sub></b>	21-22 = 150	
<b>B<sub>2</sub></b>	21-22 = 250	

### CONNECTION OPTIONS

6 x 1/2" BSP (15/21).  
A vertical radiator can be used in 2-pipe systems and in 1-pipe systems, when the valve set is used.

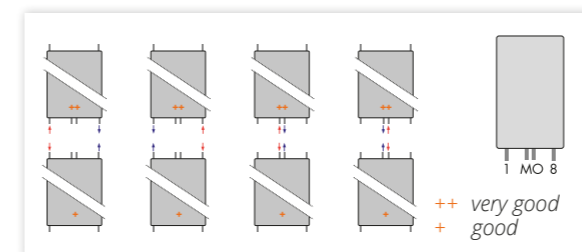

### TOP VIEW

top bracket  
types 21 & 22

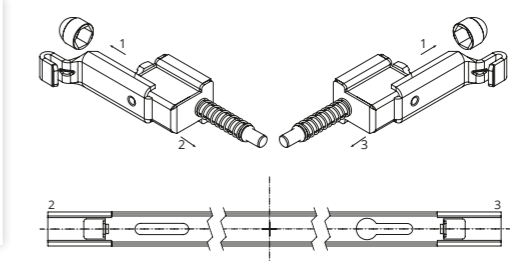

bottom bracket  
types 21 & 22



## KOS H

### type 21, 22



#### type 21

ORDER CODE : KOH21XXXXYYZZ  
 EXAMPLE : KOH216001200L  
 radiator \_\_\_\_\_  
 type \_\_\_\_\_  
 height \_\_\_\_\_  
 length \_\_\_\_\_  
 Z = L : left conn. • R : right conn.

#### type 22

ORDER CODE : KOH22XXXXYYZZ  
 EXAMPLE : KOH226001200L  
 radiator \_\_\_\_\_  
 type \_\_\_\_\_  
 height \_\_\_\_\_  
 length \_\_\_\_\_  
 Z = L : left conn. • R : right conn.

Thermal output of radiators in watts (90°C in / 70°C out / 20°C room)

Length	Height	
	Type 21	Type 22
600	1007	1278
750	1260	1603
900	1511	1924
1050	1769	2245
1200	2021	2565
1350	2275	2886
1500	2527	3207

Volume: l/m	6.95	6.95
Weight: kg/m	37.43	42.67

Special order (approximate delivery lead time 12-20 weeks)

## KOS H

A horizontal decorative radiator with a flat front panel and unique slightly curved sides. This horizontal model is provided with an adapted top cover that emphasises its unique design.

Accessories included in the package: brackets, screws and plugs.

The thermostatic (Kv-adjustable) valve body is factory fitted on the right, the air vent on the left.

- **Operating pressure:**  
Tested to a pressure of 8 bar.  
Working pressure of up to 6 bar.
- **Connections:** 2 x ½" BSP.
- **Warranty:** 10 years.



**HEIGHT**  
600mm

**LENGTH**  
600 - 1500mm

**TYPE**  
KOH21, 22

**FINISH**  
White RAL 9016.  
Other RAL, sanitary and special colours are available upon request. Please note, there is a 40% supplement for non-standard colours. See page 26 for colour options.

### TECHNICAL INFORMATION

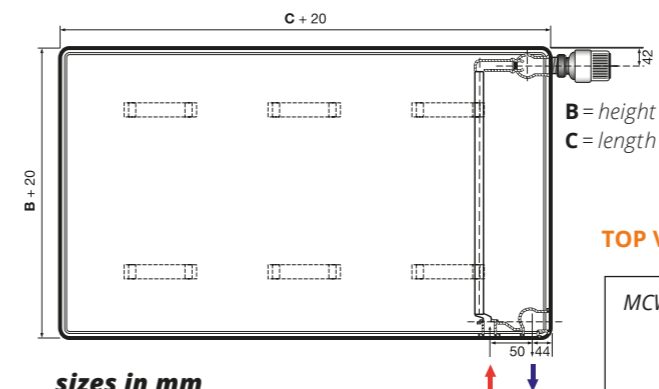

#### sizes in mm

Type	Height (B)	Length (C)	4x
21/22	600	<2000	x

#### CONNECTION OPTIONS

2 x Ø ½" (15/21) – bottom right, left available on request.

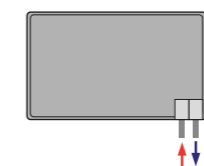

#### TOP VIEW

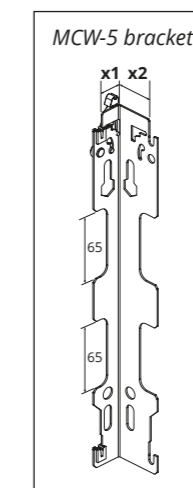

#### TOP VIEW

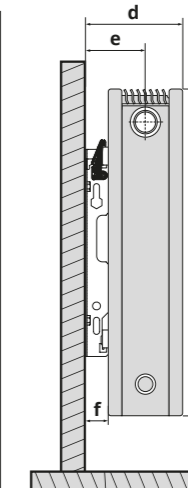

#### SIDE VIEW

type 21

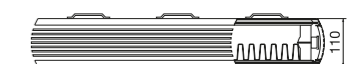

type 22

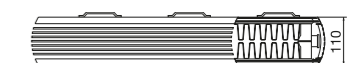

B = height



## TINOS

The modern and stylish Tinos is a decorative vertical radiator. Its grand front panel with straight edge covers the latest in heating design. It is suitable for a wide range of applications and adds design appeal to any setting.

- **Operating pressure:** Tested to a pressure of 8 bar. Working pressure of up to 6 bar.
- **Connections:** 2 x 1/2" BSP.
- **Warranty:** 10 years.

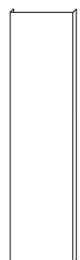

**HEIGHT**  
1800mm

**LENGTH**  
475, 625mm

**TYPE**  
TIV11, 21

**FINISH**  
White RAL 9016.  
Other RAL, sanitary and special colours are available upon request. Please note, there is a 40% supplement for non-standard colours. See page 26 for colour options.

## TINOS

type 11, 21



### type 11

ORDER CODE : TIV11XXXXYYY  
EXAMPLE : TIV111800475

radiator \_\_\_\_\_  
type \_\_\_\_\_  
height \_\_\_\_\_  
width \_\_\_\_\_

### type 21

ORDER CODE : TIV21XXXXYYY  
EXAMPLE : TIV211800600

radiator \_\_\_\_\_  
type \_\_\_\_\_  
height \_\_\_\_\_  
width \_\_\_\_\_

Thermal output of radiators in watts (90°C in / 70°C out / 20°C room)

Height		
	Type 11	Type 21
Length	1800	1800
475	1226	1675
625	1635	2232

475		
Volume: l/m	525	9.66
Weight: kg/m	30.37	45.12
625		
Volume: l/m	7.00	12.88
Weight: kg/m	39.73	60.16

Special order (approximate delivery lead time 12-20 weeks)

## TECHNICAL INFORMATION

### SIDE VIEW

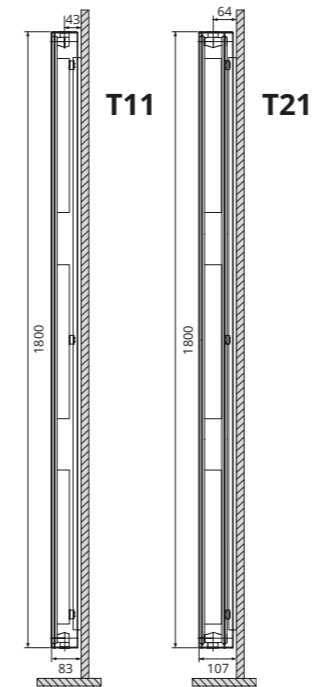

### TOP VIEW

type 11

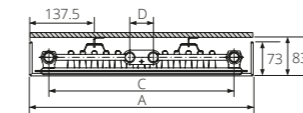

type 21

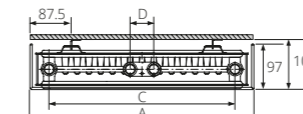

### INSTALLATION

type 11

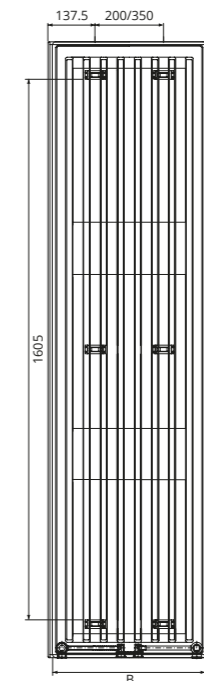

type 21

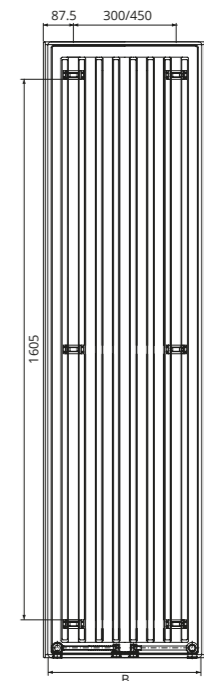

bracket MCW-V  
types 11 & 21



### CONNECTION OPTIONS

6 x 1/2" BSP (15/21).

Tinos can be used in 2-pipe systems and in 1-pipe systems, when the valve set is used.

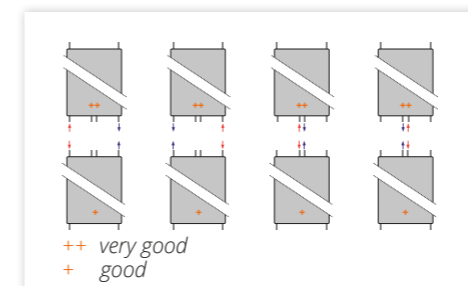

A overall width	B rad width	C centres	D centres
475	450	394	50
625	600	544	50



## LEROS



**A = centre-to-centre connections**  
**B = height**  
**C = width**  
**D = centre-to-centre bracketsHORI**  
**X = centre-to-centre bracketsVERTI**

Thermal output of radiators in watts (90°C in / 70°C out / 20°C room)

Order code	A	B	C	D	X	Weight (Kg)	Volume (l)	(Watt)	Colour
LER1206M	50	1224	600	500	924	11.55	5.85	762	white
LER1806M	50	1812	600	500	1512	16.45	8.25	1096	white
LER1206MB	50	1224	600	500	924	11.55	5.85	764	black textured
LER1806	50	1812	600	500	1512	16.45	8.2	1096	black textured

Special order (approximate delivery lead time 12-20 weeks)

## LEROS

The Leros bathroom radiator is an impressive addition to the Purmo range. Its modern styling, contemporary appearance and well thought out design inspire confidence in the quality associated with the Purmo name. The large diameter of the tubes (28mm) provide a solid and stylish appearance whilst the larger gaps offer a practical solution for placing towels. The Leros is stocked in white and black textured and also available in a range of colours. Its striking design will stand out in any bathroom.

- **Operating pressure:**  
Tested to a pressure of 13 bar.  
Working pressure of up to 10 bar.
- **Connections:** 4 x 1/2" BSP.
- **Warranty:** 10 years.

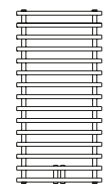

**HEIGHT**  
1224, 1812mm

**WIDTH**  
600mm

**FINISH**  
White RAL 9016 and black textured S0141. Other RAL, sanitary and special colours are available upon request. Please note, there is a 40% supplement for non-standard colours. See page 26 for colour options.

## TECHNICAL INFORMATION

### INSTALLATION

4 wall brackets.

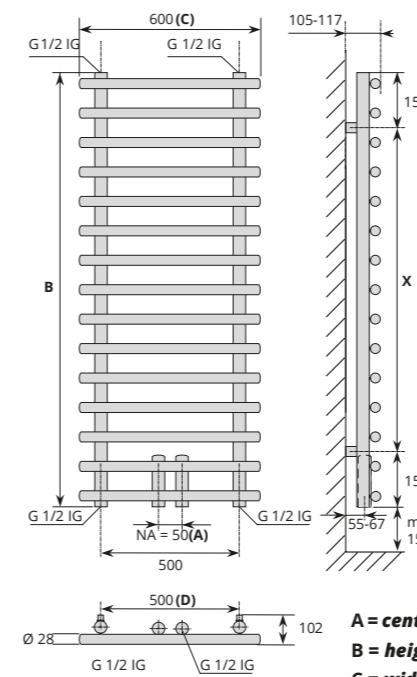

**A = centre-to-centre connections**  
**B = height**  
**C = width**  
**D = centre-to-centre bracketsHORI**  
**X = centre-to-centre bracketsVERTI**

### CONNECTION OPTIONS

- 4 connections 1/2" internal thread (15/21).
- When the radiator is installed using the bottom left and right connection option, rather than the mid-connection, the output is reduced due to no water flow through 2 pipes.
- Max. working temperature: 110°C.

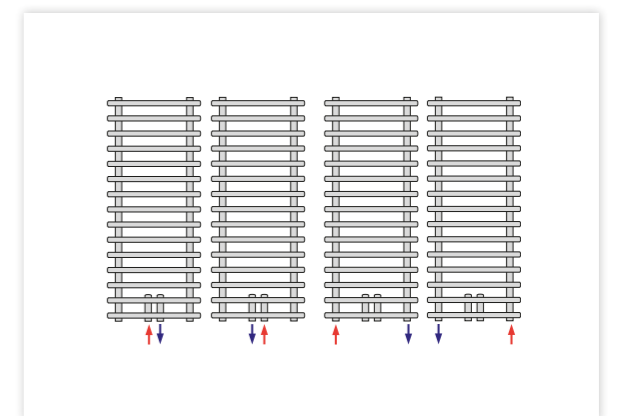

## COLOUR OPTIONS

All products featured in this brochure are stocked in white (RAL 9016). Other colours are available on request (see below and right). **Please refer to individual product pages as not all products can be ordered in other RAL or special colours. Price supplement applies on standard RAL and special colours.**

### RAL COLOURS

Surcharges for other RAL and special colours from the palette presented below:

+40% – All panel radiators (excluding Vertical)

+20% – Vertical

RAL 1004 Golden yellow	RAL 1012 Lemon yellow	RAL 1023 Traffic yellow	RAL 1027 Curry yellow	RAL 1033 Dahlia yellow	RAL 2003 Pastel orange	RAL 2004 Pure orange	RAL 3000 Flame red
RAL 3005 Wine red	RAL 3014 Antique pink	RAL 3015 Light pink	RAL 4002 Red violet	RAL 4007 Purple violet	RAL 4008 Signal violet	RAL 4009 Pastel violet	RAL 5001 Green blue
RAL 5002 Ultramarine blue	RAL 5009 Azure blue	RAL 5014 Pigeon blue	RAL 5015 Sky blue	RAL 5017 Traffic blue	RAL 5022 Night blue	RAL 6004 Blue green	RAL 6019 Pastel green
RAL 6033 Mint turquoise	RAL 6034 Pastel turquoise	RAL 7001 Silver grey	RAL 7013 Brown grey	RAL 7015 Slate grey	RAL 7016 Anthracite grey	RAL 7021 Black grey	RAL 7024 Graphite grey
RAL 7030 Stone grey	RAL 7035 Light grey	RAL 7037 Dusty grey	RAL 7040 Window grey	RAL 8017 Chocolate brown	RAL 8019 Grey brown	RAL 9001 Cream	RAL 9005 Jet black
RAL 9006 White aluminium	RAL 9007 Grey aluminium	RAL 9010 Pure White	RAL 040 80 05 Caffé Latte (S0222)	RAL 120 70 70 E-Green (S0221)	RAL 120 80 60 Modern green (S0220)	RAL 150 60 60 Green Apple (S0219)	RAL 250-2 Lemon Glow (S0182)
RAL 290 40 45 Mystic Purple (S0185)	RAL 290 70 20 Mauve Haze (S0178)						



### SPECIAL COLOURS

Surcharges for other RAL and special colours out of the palette presented below:

+100% – All panel radiators (excluding Vertical)

+50% – Vertical

S0075 Jasmine	S0077 Magnolia	S0084 Anemone	S0087 Bahama beige	S0088 Manhattan	S0091 Pergamon	S0094 Natura	S0164 Banana
S0102 Metal Grey <sup>2</sup>	S0104 Metal Black <sup>2</sup>	S0141 Black Textured <sup>1</sup>	S0142 White Textured <sup>1</sup>	S0143 Light Grey	S0144 Brown Grey	S0145 Creme White	S0146 Anodic Bronze
S0147 Anodic Brown	S0148 Anodic Black	S0149 Anodic Natura	S0201 Metal Alu <sup>2</sup>				

<sup>1</sup> textured colour

<sup>2</sup> metallic colour

Colours presented here should be considered as demonstrative. Before purchase, the colours should be selected based on the original colour chart only. The manufacturer is not responsible for the selection of colours based on materials printed or displayed on a computer display.

**Note\*** Different types of radiators can have different shades of the same colour.

All our non-stocked and special colour items are made to order. Should an order be cancelled after it has been placed with the factory an administration fee of 40% of the product value may be applied.

**Note\*** Special order products may incur freight costs and extended delivery lead time up to 20 weeks from date of order.

Please note: due to print restrictions exact colour match is not always possible, however every effort has been made to ensure as much accuracy as possible.

## Reece. Works for you.™

Call **1800 032 566** or visit **[www.reece.com.au](http://www.reece.com.au)** for your nearest Reece store.  
Due to limitations in the printing process the colours in this brochure are a guide only.

The manufacturer/distributor reserves the right to vary specifications or delete models from their range without prior notification. The manufacturer/distributor takes no responsibility for printing errors.  
All products enjoy a product replacement warranty. For full warranty details visit [www.reece.com.au/product quality](http://www.reece.com.au/product quality)

V2 2021

**PURMO** 

**reece**™