

henden™

Balance

INSTALLATION & OWNER'S MANUAL

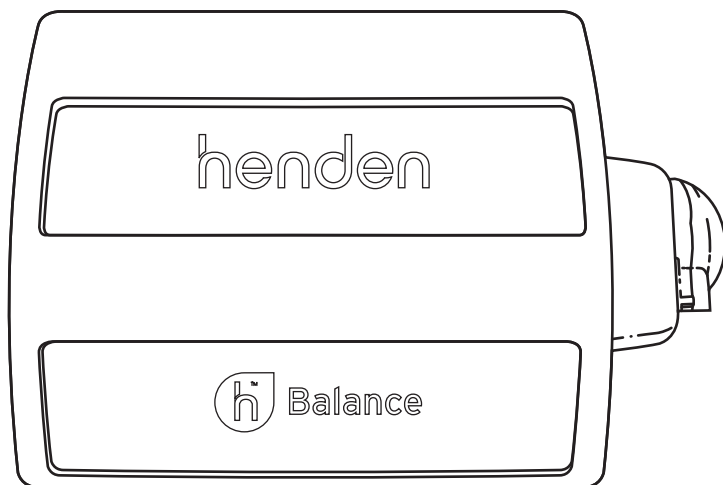

IMPORTANT
Please read carefully



CAUTIONS AND WARNINGS:

Installation must be handled by a professional pool builder/service agent.

The Henden Balance is not intended for use by young children or infirm persons without supervision.

Always store pool chemicals in a well-ventilated position, at least 1.8M away from the pool equipment to prevent fume build-up and cause corrosion of the pool equipment.

Only use diluted acid, never use direct pool acid. Acid should be diluted with water to a minimum dilution of 1 part acid to 2 parts water (1:2). Always follow the manufacturers safety guidelines when handling pool chemicals.

It is the pool owner's responsibility to tell any parties testing the water that this system uses an ORP probe.

Maintain the Cyanuric Acid (Stabiliser) level of the pool at 5-15ppm.

Contents

Balance

Introduction	4
Helpful Hints	4
Specifications	5
In the Box	6
Installation	8
Updating Firmware	14
Confirming Henden Balance Sync to Henden Control	14
Chemical Setup	16
pH Sensor Settings	17
ORP Sensor Settings	18
Setting Chemical Balance in the App	19
Diagnostics	20
Maintenance Schedule	21
Probe Cleaning Instructions	22
Replacing the Squeeze Tube	23
Trouble Shooting and Fault Finding	25
Warranty	27

INTRODUCTION

Thank you for purchasing the Henden Balance.

The Henden Balance monitors and maintains pH and ORP levels, helping you maintain a perfectly balance pool.

HELPFUL HINTS

- > pH is a measurement of how Acidic or Alkaline the pool water is. The ideal pH level is from 7.2 - 7.6.
- > ORP Is a measurement of the effectiveness of the sanitiser (chlorine) in the pool water and is measured in millivolts.
- > The Henden Balance is not designed to bring the pool system into balance, it is designed to maintain a balanced system.
- > Before installing the Henden Balance take a sample of the water to a Reece Irrigation & Pools branch and have it tested to ensure that the water is properly balanced.
- > Henden recommends that you check the water chemistry regularly, to ensure that the Henden Balance is operating correctly and to ensure that the pH and ORP sensors are reading accurately.
- > Henden Recommends that before you install the Henden Balance, you sit the probes in the pool water for 24hrs. This will help the probes give a more accurate reading from the time of installation and increase the lifespan of the probes.

SPECIFICATIONS

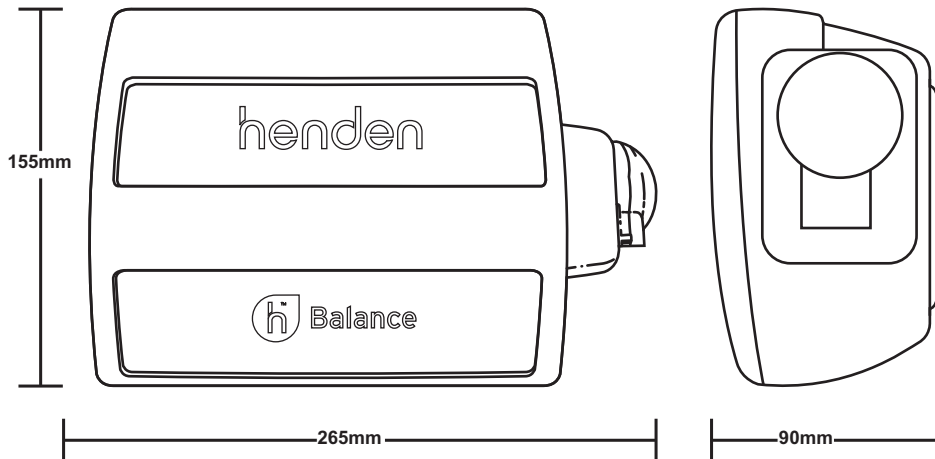

IN THE BOX

5m length of tubing

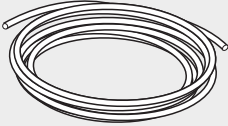

50mm injection manifold

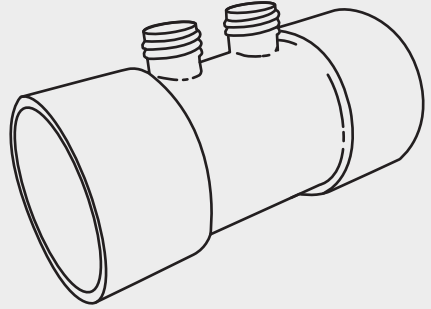

50mm sensor manifold

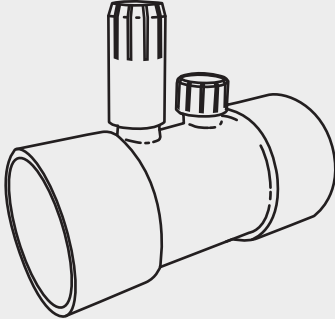

Henden Balance with attached peristaltic pump

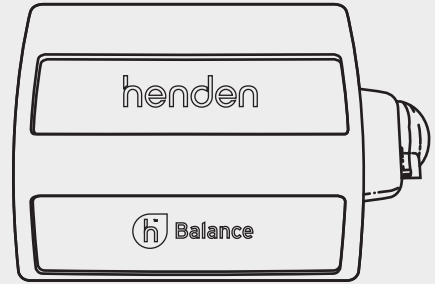

ORP Sensor (Yellow Connector)

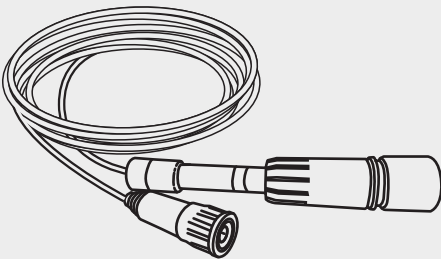

pH Sensor (Blue Connector)

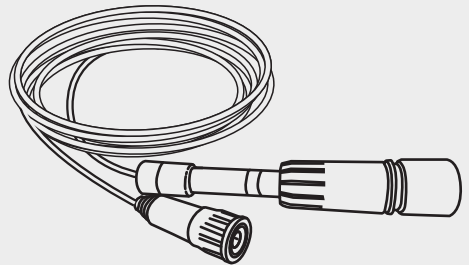

IN THE BOX

Dosing tube check valve

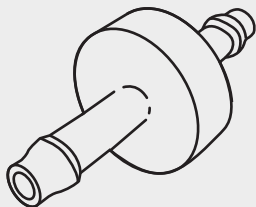

Through shed wall connector

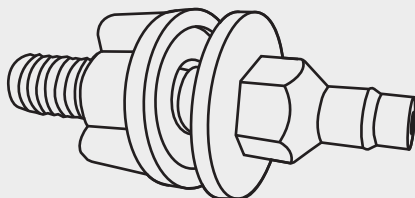

Communication cable to connect the Henden Balance to the Henden Control or a Henden Control Expansion module

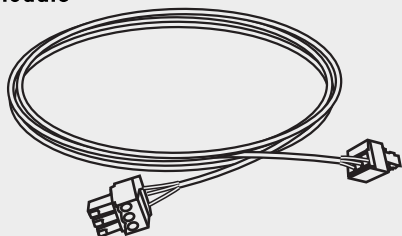

Power cable to connect the Henden Balance from a valve actuator port in the Henden Control

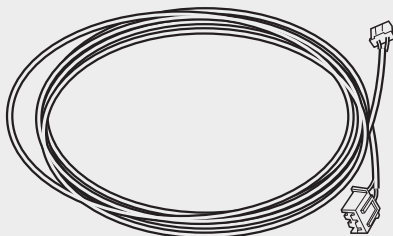

Chemical drum connection kit

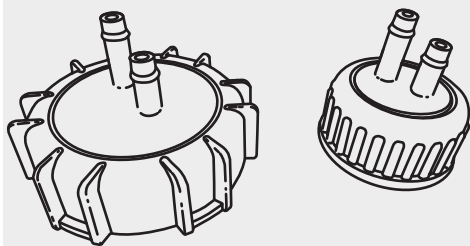

Squeeze tube and lubricant

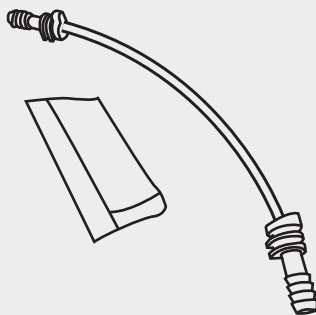

INSTALLATION

Positioning the Henden Balance

Handy Tip: Ideally the controller should be installed out of direct weather. The service life of the Henden Balance will be longer if it is not exposed to direct sunlight and rain.

- 1 Position the Henden Balance 3 meters from the waters edge and at least 600mm above ground level.

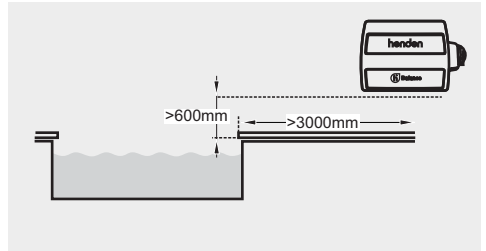

- 2 Lock the Henden Balance into place by sliding the controller down onto the mounting bracket and adjust screws on the back to ensure a snug fit.

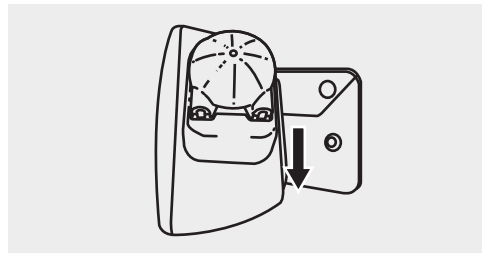

Full Installation Setup

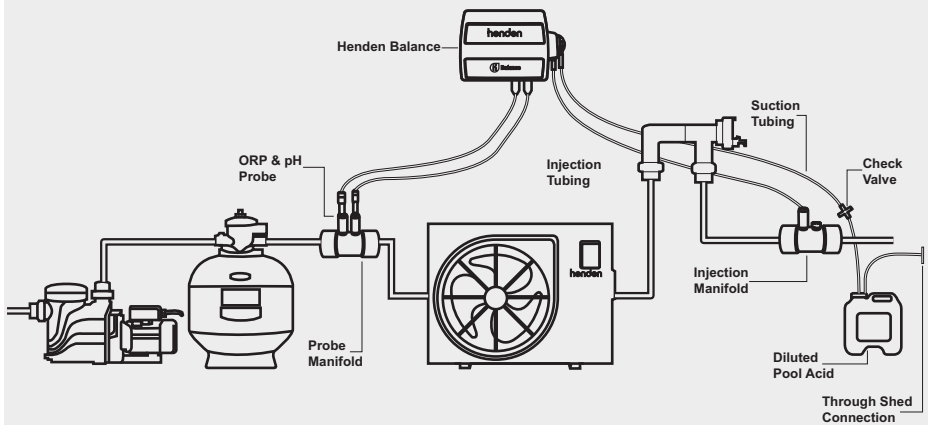

INSTALLATION

Electrical Connections

- 1 Connect the pH and ORP probes into the ports on the bottom of the Henden Balance.

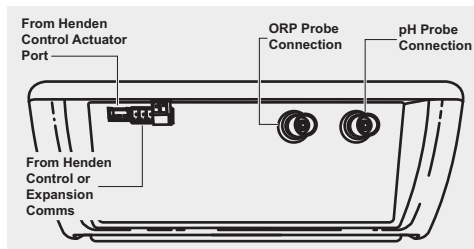

- 2 Connect the communication cable from the Henden Balance into either the Henden Control or into the right-hand port of the last Henden Control Expansion Module.

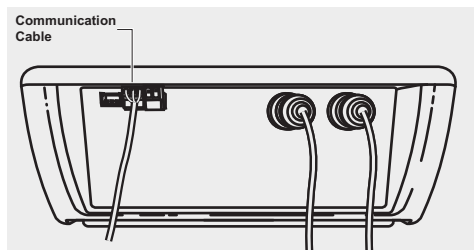

WARNING: Do not connect power to the Henden Balance until the installation procedure is complete. Follow the guide to see when to connect power.

INSTALLATION

Installing the Probe Manifold

Handy Tip: The pH and ORP probes will be supplied in small bottles of solution. Rinse out and keep these bottles for long term storage capability of the probes.

- 1 Install the probe manifold in horizontal pipework between the filter and next piece of pool equipment. Ensure the probe inserts are at the top.

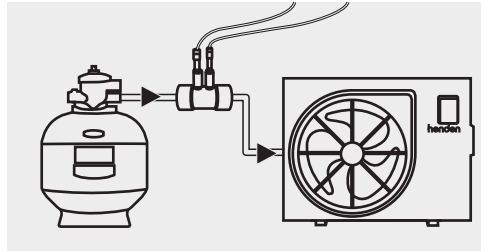

- 2 Install the probes in the probe holders so that the probe tips are inserted halfway into the pipework.

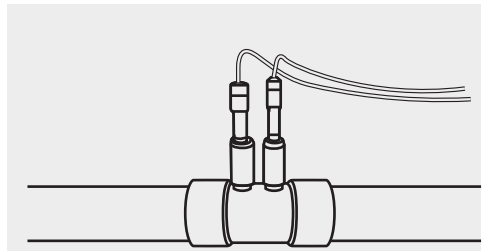

- 3 Hand tighten the probe locking nuts to secure the probes in the manifold.

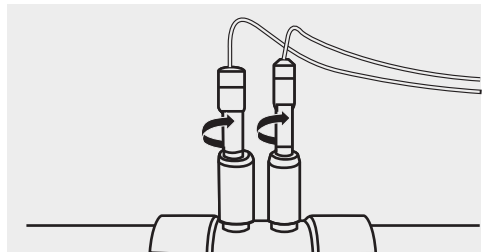

WARNING: Pushing the probes too far into the pipework can cause them to break.

INSTALLATION

Installing the Squeeze Tube

- 1 Remove the dosing pump cover by lifting the lip outwards from the bottom.

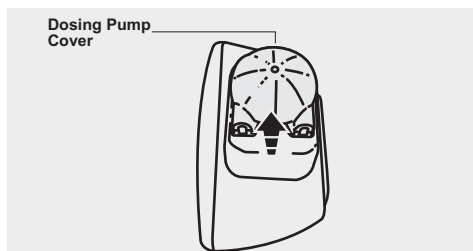

- 2 Remove the pump head and wrap the squeeze tube around the rollers. Ensure that you apply some silicon based lubricant onto the pump head and squeeze tube before installing onto the motor shaft.

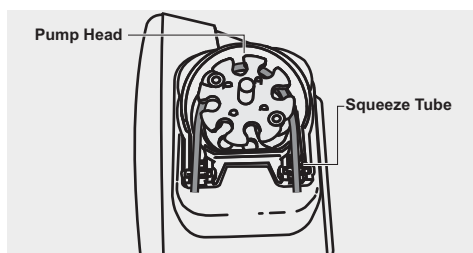

- 3 Check the squeeze tube is seated correctly then re-install the head cover.

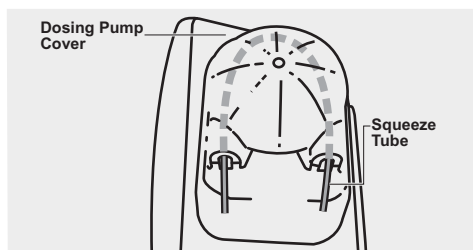

- 4 Ensure the barbs on the squeeze tube are not seated in the pump casing.

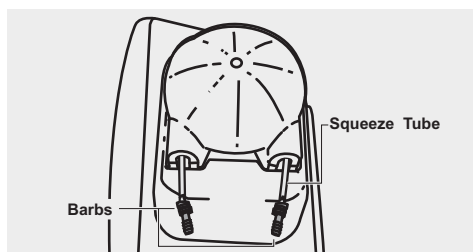

INSTALLATION

Installing the Injection Manifold

- 1 Install the injection Manifold into the pipework downstream of all other equipment. This is typically after the chlorinator cell housing.

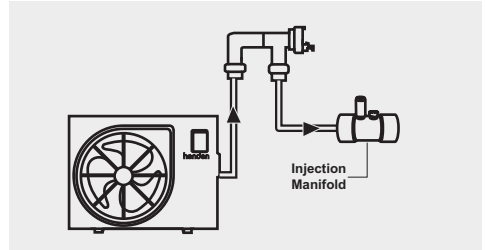

- 2 Ensure the blanking cap is installed on the unused injection port to prevent water leaking.

Handy Tip: Soak the ends of supply and injection hoses in hot water for 30 seconds to soften them, this will make it easier when fitting the tubes to the pump barb.

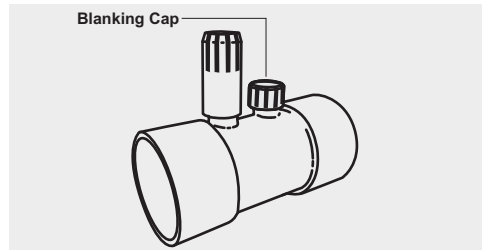

- 3 Attach the injection tubing onto the injection manifold then connect the other end of the injection tubing onto the right-side outlet of the acid dosing pump squeeze tube.

Handy Tip: Allow a little extra tubing length in case the injection tubing needs to be trimmed at a later stage.

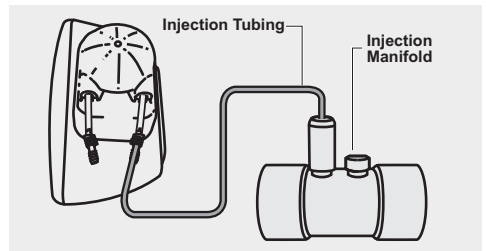

- 4 Screw the lid kit onto the drum of diluted pool acid and connect the suction tubing to the lid kit. Then connect the other end of the suction tubing to the left-side inlet of the acid dosing pump.

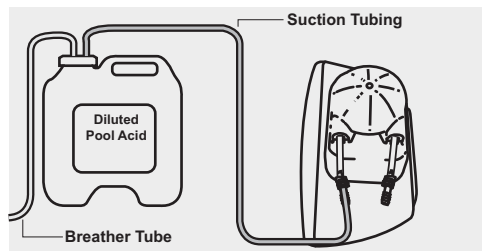

INSTALLATION

- 5** Install the check valve between the acid dosing pump and the lid of the acid drum.

Handy Tip! Ensure you install the check valve in the direction to prevent back flow into the acid drum.

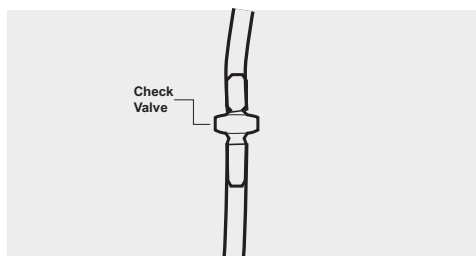

WARNING: Keep the acid drum a minimum of 1.8m from the Henden Balance and equipment.

If the drum of pool acid is stored in an enclosed area, corrosive fumes may damage surrounding items.

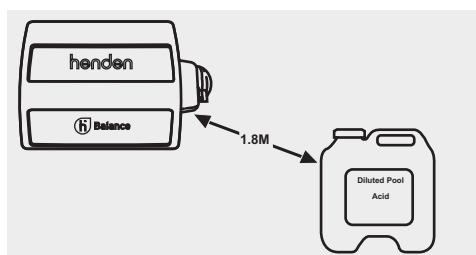

- 6** A through shed connection for the breather tube is supplied to prevent a build-up of fumes inside the shed/shelter. Attach the spare tubing on the breather port on the drum lid and run it away from equipment to an open area.

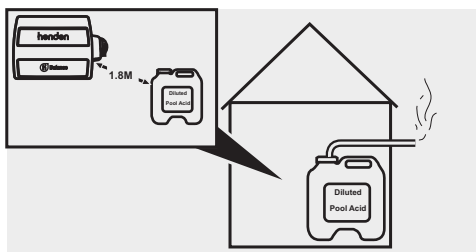

Connecting the Power Supply

- 1** Connect the power cable from a valve actuator port at the base of the Henden Control to the Henden Balance.

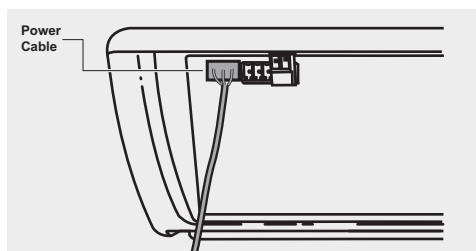

UPDATING FIRMWARE

Handy Tip: Ensure that the Henden Balance is running the latest version of software. If not, complete any available Firmware Updates.

- 1 To update the Firmware for the Henden Balance, use the app menu, tap on device, then 'view' next to the device information.
- 2 Tap the box "Update Available" underneath the wording; "Henden Balance Version xxxx".

WARNING: Don't make changes via the app or on the Henden Control while the update is in progress.

CONFIRMING HENDEN BALANCE SYNC TO HENDEN CONTROL

Handy Tip: If your Henden Balance has not automatically been detected follow the steps below to manually sync the Henden Balance to the Henden Control:

- 1 Press the Menu button on the Henden Control until you see '1. Filter Times' appear, press down to '6. Installer Setup' and press Enter. You will see '6-1. Appliances', press down to '6-10 Expansion Units' and press Enter.
- 2 Continue pressing Enter to get through all the settings to do with the normal Expansion Units.

- a. The controller will display:

```
EXP:1      1.00B1
EXP:2      NONE
```

- b. Press Enter and the controller will then display:

```
NUMBER     EXP
UNITS 1
```

- c. Press Enter and the controller will display:

```
RESET ALL
ADDRESSES NO
```

- d. Ensure that NO is displayed and press Enter. The controller will display:

```
SCAN FOR EXP
UNITS NOW? NO
```

CONFIRMING HENDEN BALANCE SYNC TO HENDEN CONTROL

e. Ensure that NO is displayed and press Enter. The controller will then display:

**HENDEN BALANCE
VI.00B07**

(If communication is already received, otherwise this line will be blank)

Handy Tip: If the version number is already displayed then the Henden Balance is now ready to be used through the App, you can exit the menu by pressing the 'Menu' button.

Handy Tip: If you need to reset the Henden Balance press Enter and see below steps.

3 If the lower line was blank, press Enter and the controller will display:

**RESET
HENDEN BALANCE NO**

4 To Reset the Henden Balance or install another unit, use the ↑ or ↓ buttons to change from NO to YES and press Enter. The controller will then display that the "Reset Done", press Enter to move to the next function.

5 If you are setting up the Henden Balance for the first time, make sure the controller has NO displayed and press Enter. The controller will display:

**SCAN HENDEN BALANCE
NOW NO**

6 If you don't want to scan for the Henden Balance, make sure the controller is displaying NO and press Enter and the controller will exit you to the Installer Menu.

7 If you have reset the Henden Balance or are setting it up for the first time you will use the ↑ or ↓ buttons to change from NO to YES and press Enter. After a few seconds of searching, the controller will then display:

**HENDEN BALANCE
VI.00B07**

8 Once displayed, the Henden Balance is now active and can be utilised through the Henden Control App. Exit the Expansion menu by pressing the Menu button on the controller.

9 Open the app, you will now see Chemical Balance and Chemical Setup in the menu.

CHEMICAL SETUP

Handy Tips:

- > ORP measures how effective the chlorine in the water is. It does not measure the amount of chlorine in the pool water.
- > pH is a measurement of how Acidic or Alkaline your pool water is. The ideal pH level is from 7.2 - 7.6.
- > A pH level too low can cause damage to equipment, irritation to swimmers, overuse of chemicals or damage to the pool interior. A pH level too high will have adverse effects on water chemistry.
- > Chlorine, pH, Cyanuric acid (Stabiliser) and general water contaminants all effect the ORP level.

Note: The Henden Balance is not designed to balance the pool. It is designed to help maintain the balance of the pool.

- 1 Open the chemical set up menu in the Henden Control app. Set the pool and spa volumes to the nearest value, then tap on the buttons beside pH sensor and ORP sensor to activate them.

PH SENSOR SETTINGS

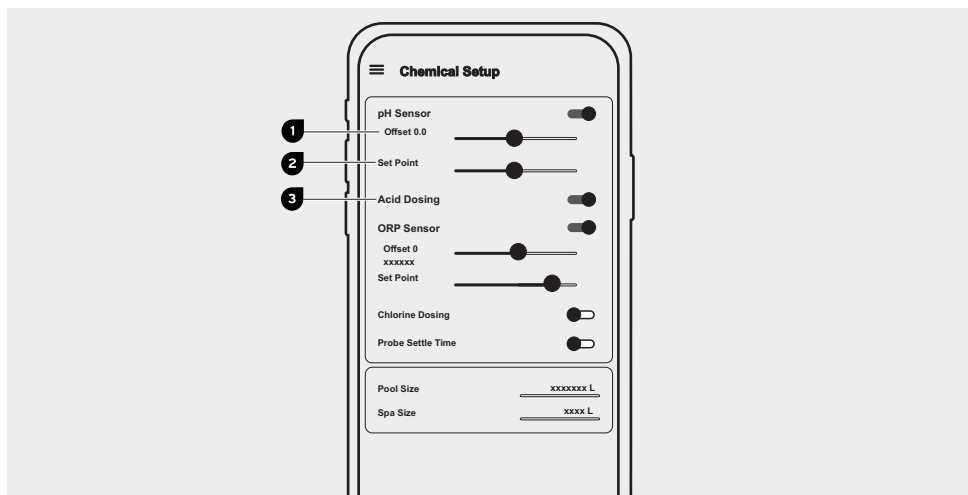

Interpreting the Settings

- 1** **Offset** allows you to adjust the reading of the probe. The probe may be reading pH at 7.7 but after proper testing of the pool water the actual reading may be 7.6. You would then adjust the offset to -0.1.
- 2** **Set Point** is the level that you would like the pool system to be running at. Use the slider to adjust the setpoint.
- 3** **Acid Dosing** slider can be used to activate/de-activate the acid dosing pump attached to the side of the Henden Balance.

Handy Tip: The acid dosing button will generally be left on. Turn it off if there is a problem with the pump or you are changing over the acid drum.

ORP SENSOR SETTINGS

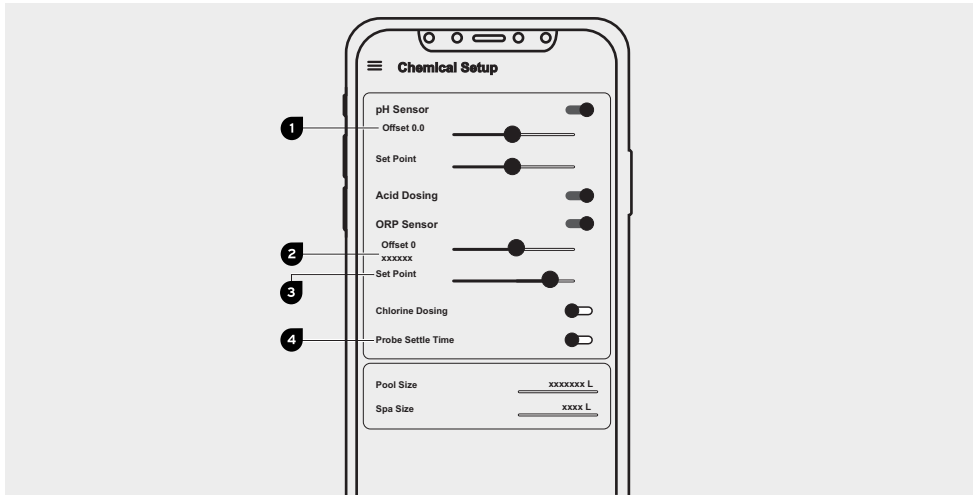

Interpreting the Settings

1 **Offset** will allow you to adjust the reading of the probe to be lower or higher.

2 The reading in the brackets is the current ORP reading.

3 **Set Point** is the level that you would like the pool system to be running at. Use the slider to adjust the setpoint. The higher the setpoint the more efficient the sanitiser will be. This will typically increase the chlorine level in the pool.

4 When the **Probe Settle Time** is turned on, no dosing is done in the first 30 minutes after the circulation pump is turned on. If the setting is turned off, dosing will commence as soon as the circulation pump starts.

Handy Tips:

- > The 'Chlorine Dosing' button is not currently functional and will have no effect on the system.
- > Acid is only dosed when the pH reading is higher than the pH Set Point. If the PH reading is above 8.5 then acid will not be dosed. You will need to manually add acid to lower the pH.
- > The pH Offset will only allow adjustment of up to +1.5 or -1.5 points.
- > Chlorine is added/dosed only with the ORP reading is below the ORP set point. If the reading is below 300mV then chlorine will not be dosed, and you will need to manually add chlorine.
- > The ORP Offset will only allow an adjustment of +150mV to -150mV.

SETTING CHEMICAL BALANCE IN THE APP

- 1** Adjust the setpoint levels for both pH and ORP using the sliders in the chemical balance option of the Henden Control App.
- 2** Press the 'Prime' button to cycle the acid dosing pump for 10 seconds to get the pump primed and to test operation.
- 3** The pH and ORP status will now be visible on the Home screen. Tap the down arrow on the right-hand side of the box to expand the chemical balance window.
- 4** Select either the pH or ORP button to display:
 - a. The current level as low, normal or high.
 - b. The actual level of the pool system.
 - c. The set point to achieve.

DIAGNOSTICS

If the pool water is not balanced correctly, you may see 'CHECK' on the home screen of the App. This will show when either, the pH reading is outside of the range of 5.5 - 8.5, or when the ORP reading is outside of the range of 300mV - 800mV.

WARNINGS:

- > When 'CHECK' is displayed in the pH box, the Henden Balance won't dose acid.
- > When 'CHECK' is displayed in ORP box, the Henden Balance won't add chlorine.
- > If the system is displaying '---', it indicates that there may be a fault with the probe itself or there is an invalid reading.

Handy Tip: When the system is displaying CHECK, you may need to manually adjust the chemical balance for the Henden Balance to resume normal operation. Henden recommends taking a sample of the pool water to the local pool shop and get it tested to rebalance.

MAINTENANCE SCHEDULE

Regular checks and maintenance will ensure trouble free performance and longevity of the Henden Balance.

FREQUENCY	MAINTENANCE
Fortnightly	Check the level of the acid drum to ensure that it won't run dry.
	Test total pool water chemistry for correct balance.
3 Monthly	Ensure that the check valve is holding liquid in the feed tube.
	Check and ensure that the acid feeding tube is clean and clear where it injects acid into the piping. Clean or trim tubing if required.
6 Monthly	Get the pool water chemistry tested at a pool store. Adjust calibration of the sensor readings if required. Use the pH and ORP offsets to adjust.
	Check all tubes, fittings and connections for damage or leaks.
	Check the squeeze tube in the peristaltic pump to ensure that it isn't leaking, replace if needed. Apply silicon lubricant to the tube and gears if necessary.
	Clean and re-calibrate the probes if necessary. Cleaning instructions are on page 22 of this manual.
Yearly	As it is a high wear component, the squeeze tube should be replaced every 12 months.

Note: If the pool system is to shut down for a lengthy period of time (e.g.; repairs to the pool surface), Henden recommends the pH & ORP probes be removed from the Injection Manifold and be stored appropriately. This involves putting storage fluid (20% KCl) into the small bottles the probes came in, putting the probes into the fluid, and screwing the nut to the top of the bottle.

WARNING: If you don't remove the probes and put the pH & ORP probes into the storage solution, the probes may be damaged, and they won't be covered under warranty.

PROBE CLEANING INSTRUCTIONS

WARNING: The cleanliness of the sensor and connector is critical for an accurate measurement. Drift (Offset) and a slow reading response are often due to an unclean sensor or junction. **DO NOT** use any abrasive materials to clean the probe.

Handy Tips:

- > To remove inorganic deposits and scale: Soak the probe in diluted pool acid 10:1 (water : acid) for an hour. Wash well with water and condition in 20% KCl solution before use.
- > To remove solids and organics: Wipe the membrane with a microfibre cloth soaked in mild non-alkaline detergent. Wash with water and condition in 20% KCl before use.
- > Increased handling of the probe also increases the chance of scratching or damaging the probe tip.
- > Calibrate the pH probe regularly. The frequency of calibration will depend on the level of accuracy desired. When calibrating, always use fresh buffer solution.
- > Clean the ORP probe periodically. Unclean sensor tips are a very common source of error in ORP measurements.

REPLACING THE SQUEEZE TUBE

- 1 Open the Henden Control App Menu and go into 'Chemical Setup'. Turn the 'Acid Dosing' button to the Off position. This will stop the dosing pump from operating while you are replacing the squeeze tube.

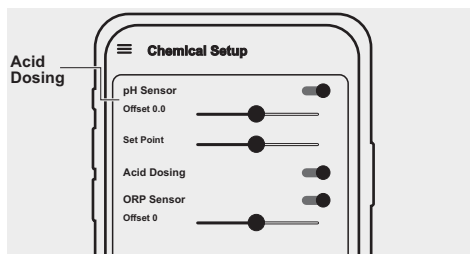

- 2 Remove the chemical tubing from the inlet and outlet sides of the dosing pump.

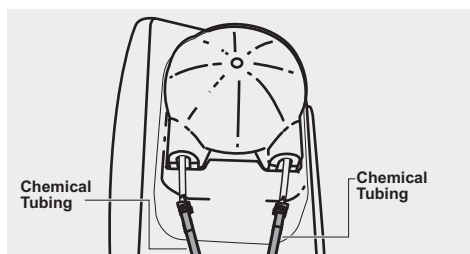

- 3 Remove the dosing pump cover by lifting outwards the lip at the bottom.

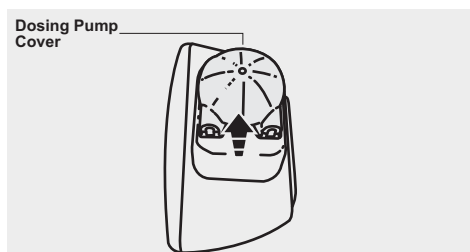

- 4 Remove the pump head and wrap around the new squeeze tube, ensure that you apply some silicon based lubricant onto the pump head and squeeze tube before re-installing onto the motor shaft.

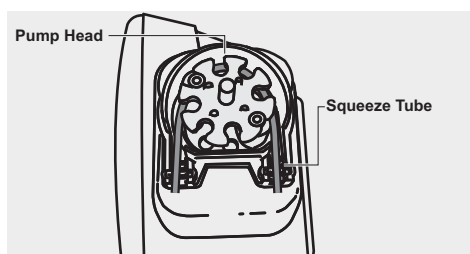

REPLACING THE SQUEEZE TUBE

- 5 Ensure that the squeeze tube is seated correctly then re-install the head cover.

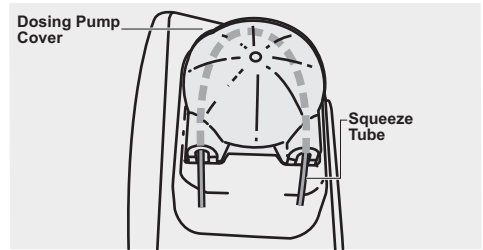

- 6 Re-attach the tubing to the inlet and outlet of the dosing pump squeeze tube.

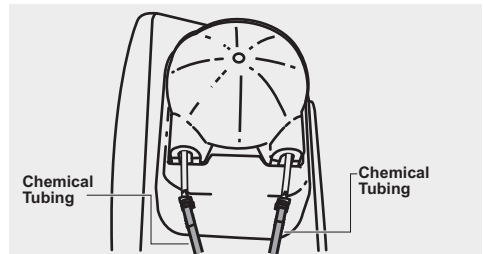

- 7 Once re-installed, use the 'Chemical Setup' menu in the Henden Control App and turn the 'Acid Dosing' button back to the On position.

- 8 Press 'Prime' to test the dosing pump operation and for leaks.

TROUBLE SHOOTING AND FAULT FINDING

Henden recommends testing the water chemistry with either a good quality test kit or take a sample of the pool water to your local pool store and have it tested.

FAULT	CAUSE	SOLUTION
pH is too Low	pH probe not reading correctly	Re-calibrate the probe and clean, if necessary, otherwise adjust the probe offset level.
	pH Set Point is set to Low	Adjust pH Set Point to appropriate level. (7.2 - 7.8)
pH is too High	Filter run time isn't sufficiently long enough to ensure appropriate dosing levels	Lengthen the filter run time/s.
	Acid dosing drum is empty	Refill the drum with 2:1 water to acid. (Caution: Always add chemical to water)
	pH probe not reading correctly	Re-calibrate the probe and clean, if necessary, otherwise adjust the probe offset level.
	pH Set Point is set to High	Adjust pH Set Point to appropriate level. (7.2 - 7.8)
	Manual Overdosing of Chlorine (Shock Treatment)	Manually adjust the pH level to maintain balance.
Dosing pump is not operating	Multiple	Press the Prime button [as per pg 9] and confirm pump works.
	Blockage at the injection	Remove the injection tubing from the Injection Point, check/ensure the tubing is clean and clear. If not, clean/trim the end of the tubing and re-attach.
	Air leakage	Check all connections to ensure they are tight and no air leaks are occurring. If any connections look suspect, trim the tubing and re-attach.
	Acid drum is air tight	Add/ check the breather tubing. If the dosing container is air tight, it won't allow any liquid to be pumped from the container.
	Dosing pump squeeze tube is leaking	Squeeze tube needs replacing.
	Water is returning to the Acid drum	Install or replace the tubing Check valve.

TROUBLE SHOOTING AND FAULT FINDING

FAULT	CAUSE	SOLUTION
Chlorine is Low	Filter run time/s aren't sufficiently long enough or Chlorinator output isn't high enough	Lengthen filter run time/s. Increase Chlorinator output. Check sure Chlorinator is working.
	Water contaminant levels are low	The ORP sensor will detect suspended contaminants passing through the system. In periods of low usage it is recommended to continue to brush the pool walls to remove potential algae spores and periodically boost the chlorine level if it stays at a low level for long periods.
	ORP probe not reading correctly	Re-calibrate the probe and clean, if necessary, otherwise adjust the probe offset level.
	ORP Set Point is set to Low	Adjust ORP Set Point to appropriate level.
Chlorine is too High	pH level is too high	Adjust pH level to correct level.
	Total Dissolved Solid levels are too high	To decrease the Total Dissolved Solids level of the pool, introduce fresh water to dilute. Run an extended backwash to drop the level of the pool (by the amount recommended by your pool shop) and re-fill with fresh water.
	Stabiliser (cyanuric acid) level is too High	Dilute the pool with freshwater to reduce the level of Stabiliser to the appropriate level.
	ORP probe not reading correctly	Re-calibrate the probe and clean, if necessary, otherwise adjust the probe offset level.
	ORP Set Point is set to high	Adjust ORP Set Point to appropriate level.
	Chlorine has been manually added	Confirm pool balance with a water test. A chlorine removal product can be used to immediately reduce the level.

WARRANTY

HENDEN™ REPAIR OR REPLACEMENT GUARANTEE

Thank you for purchasing the Henden Balance. The Henden Balance is covered by a limited 3-year warranty against component failure or faulty workmanship from the date of installation.

By using the Henden Balance, you accept the terms and conditions of this warranty. The warranty is subject to the qualifications, conditions and limitations as described below.

Should you experience any difficulties with your Henden Balance, please contact your local Reece Irrigation & Pools branch or call 1300 Henden – our customer support line. On receipt of your claim, Henden will seek to resolve your difficulties – if the product is faulty or defective, our team will advise you on how to have your Henden product repaired, obtain a replacement or a refund. Henden does not cover normal wear or tear, or damage resulting from misuse or negligent handling, improper use for which the product was not designed or advertised, failure to properly follow the provided installation and operating instructions, failure to carry out maintenance, corrosive or abrasive water or other liquid, lightning or high voltage spikes, or unauthorized persons attempting repairs.

Where applicable, your Henden product must only be connected to the voltage shown on the nameplate. Henden does not cover freight, or any other costs incurred in making a claim. Please retain your receipt as proof of purchase; you MUST provide evidence of the date of original purchase when making a claim. To the maximum extent of the law, Henden shall not be liable for any loss of profits or any consequential, indirect, or special loss, damage to persons or property, or injury of any kind whatsoever arising directly or indirectly from Henden products. Should your Henden product require repair or service after the guarantee period; contact your nearest Reece Irrigation & Pools branch.

For a complete list of Reece Irrigation & Pools branches visit our website reece.com.au/storefinder

Technical and after sales support:

1300 HENDEN (1300 436 336)

Manufacturer:

Dontek Electronics Pty Ltd
19 Melrich Road
Bayswater VIC 3153

henden™

