



Compressor
Voltage Code : TZ

TAG4553Z

High Temp. Commercial (HP)

400V 3~ 50Hz / 440V 3~ 60 Hz

R452A / R404A / R448A / R449A

AGB4553ZTZ

Conditions	Frequency	Nominal Cooling Capacity		Sound Power ISO3745 / ISO 3743-1
		Watts	BTU/h	
EN12900 / R452A	50 Hz / 60 Hz	11101 / 13445	37853 / 45847	82 dBA
EN12900 / R404A	50 Hz / 60 Hz	11073 / 13412	37760 / 45735	82 dBA
EN12900 / R448A	50 Hz / 60 Hz	11112 / 13457	37891 / 45890	82 dBA
EN12900 / R449A	50 Hz / 60 Hz	11112 / 13457	37891 / 45890	82 dBA

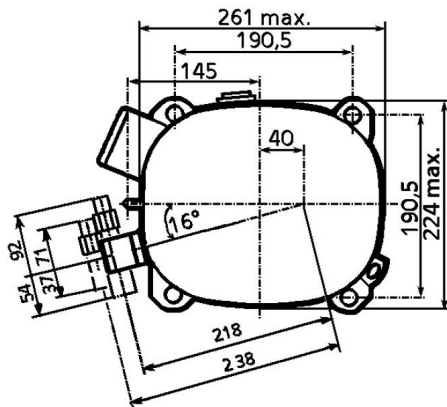
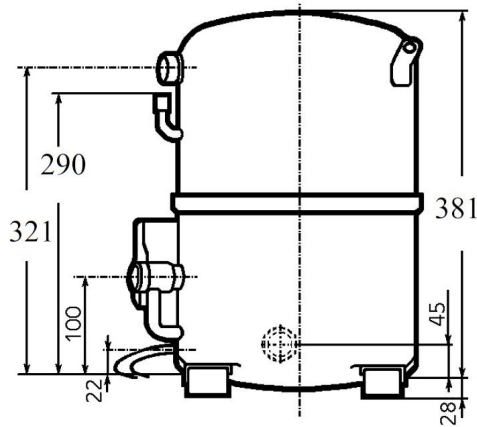

Displacement (cc)	100.7
Net Weight (Kg)	45.6
Oil Quantity (cc)	1760.0
Oil Type	Polyolester
Expansion Device	Capillary_Tube/Expansion_Valve
Cooling	Fan
Main Winding (Ohm)	3.6
Current	
RLA (A)	7.9 8.4
MCC (A)	14 14
LRA (A)	46 45
Electrical Equipment	TRI
Overload	Interne
Refrigerating connection for OD	
Suction Tube	22.2 (7/8")
Discharge Tube	15.9 (5/8")
Process Tube	6.35 (1/4")

* EN12900 : T°Cond. 50.0°C / T°Evap. 5.0°C / T°Return gas temp.. 20.0°C
T°Subcooling. 0.0K

Certificates :



Note : Tecumseh reserves the right to change information contained in this document without notification.



Tecumseh

TAG4553Z	Tension TZ : 400V 3~ 50Hz / 440V 3~ 60 Hz
-----------------	--

Les performances sont données dans les conditions EN12900 :	Gaz aspirés :	20.0 °C
Condition Dew	Sous refroidissement :	0.0 K
The performance data are in EN12900 conditions :	Return gas :	20.0 °C
Dew Condition	Subcooling :	0.0 K

50 Hz R452A											
											N°2142
4 T condensation	5 T évaporation	(°C)	-25	-20	-15	-10	-5	0	5	10	15
30	1 P frigorifique	(Watt)	3557	4955	6650	8690	11119	13985	17334	21212	25665
	2 P absorbée	(W)	1993	2360	2698	3011	3304	3580	3846	4105	4363
	3 I absorbée	(A)	4.05	4.51	4.96	5.39	5.80	6.20	6.58	6.95	7.31
40	1 P frigorifique	(Watt)		3717	5189	6926	8975	11382	14193	17455	21213
	2 P absorbée	(W)		2316	2754	3161	3541	3900	4241	4569	4890
	3 I absorbée	(A)		4.43	5.01	5.57	6.11	6.65	7.16	7.67	8.16
50	1 P frigorifique	(Watt)			3726	5174	6855	8815	11101	13758	16835
	2 P absorbée	(W)			2666	3187	3676	4136	4573	4992	5396
	3 I absorbée	(A)			4.92	5.61	6.29	6.96	7.61	8.25	8.88
60	1 P frigorifique	(Watt)				3450	4775	6301	8073	10140	12546
	2 P absorbée	(W)				3051	3668	4252	4805	5334	5842
	3 I absorbée	(A)				5.50	6.32	7.12	7.91	8.69	9.46

60 Hz R452A											
											N°2142
4 T condensation	5 T évaporation	(°C)	-25	-20	-15	-10	-5	0	5	10	15
30	1 P frigorifique	(Watt)	4537	6284	8322	10693	13439	16602	20224	24347	29013
	2 P absorbée	(W)	2538	3029	3479	3900	4307	4712	5128	5570	6049
	3 I absorbée	(A)	4.46	4.96	5.45	5.92	6.38	6.82	7.24	7.65	8.04
40	1 P frigorifique	(Watt)		4711	6554	8653	11051	13789	16910	20455	24466
	2 P absorbée	(W)		2930	3512	4046	4543	5018	5483	5952	6438
	3 I absorbée	(A)		4.88	5.51	6.12	6.73	7.31	7.88	8.43	8.98
50	1 P frigorifique	(Watt)			4682	6498	8536	10837	13445	16400	19746
	2 P absorbée	(W)			3336	4029	4665	5258	5820	6365	6906
	3 I absorbée	(A)			5.41	6.17	6.92	7.65	8.37	9.08	9.77
60	1 P frigorifique	(Watt)				4286	5952	7805	9887	12241	14908
	2 P absorbée	(W)				3722	4545	5304	6012	6681	7325
	3 I absorbée	(A)				6.05	6.95	7.84	8.71	9.56	10.4

1 = cooling capacity 2 = power input 3 = current 4 = condensing temperature 5 = evaporating temperature

Nota : Tecumseh se réserve le droit de modifier les informations contenues dans ce document sans préavis.

Note : Tecumseh reserves the right to change information contained in this document without notification.

© 2020 Tecumseh Products Company
All rights reserved



Tecumseh

TAG4553Z	Tension TZ : 400V 3~ 50Hz / 440V 3~ 60 Hz
-----------------	--

Les performances sont données dans les conditions EN12900 :	Gaz aspirés :	20.0 °C
Condition Dew	Sous refroidissement :	0.0 K
The performance data are in EN12900 conditions :	Return gas :	20.0 °C
Dew Condition	Subcooling :	0.0 K

50 Hz R404A											
N°227EU-T											
4 T condensation	5 T évaporation	(°C)	-25	-20	-15	-10	-5	0	5	10	15
30	1 P frigorifique	(Watt)	3793	5224	6947	9005	11443	14304	17630	21467	25856
	2 P absorbée	(W)	2111	2490	2837	3155	3450	3726	3988	4240	4486
	3 I absorbée	(A)	4.29	4.76	5.21	5.64	6.06	6.45	6.82	7.18	7.51
40	1 P frigorifique	(Watt)	2636	3915	5403	7143	9180	11556	14315	17501	21157
	2 P absorbée	(W)	1967	2455	2904	3317	3701	4058	4394	4714	5021
	3 I absorbée	(A)	4.10	4.70	5.28	5.84	6.39	6.92	7.42	7.91	8.38
50	1 P frigorifique	(Watt)		2598	3868	5306	6957	8865	11073	13625	16563
	2 P absorbée	(W)		2254	2825	3355	3847	4306	4737	5144	5532
	3 I absorbée	(A)		4.49	5.21	5.90	6.58	7.24	7.88	8.50	9.10
60	1 P frigorifique	(Watt)			2364	3517	4799	6255	7928	9861	12098
	2 P absorbée	(W)			2565	3230	3851	4432	4978	5494	5983
	3 I absorbée	(A)			5.00	5.83	6.64	7.43	8.20	8.95	9.69

60 Hz R404A											
N°227EU-T											
4 T condensation	5 T évaporation	(°C)	-25	-20	-15	-10	-5	0	5	10	15
30	1 P frigorifique	(Watt)	4838	6625	8693	11082	13831	16980	20570	24639	29229
	2 P absorbée	(W)	2688	3196	3658	4087	4498	4903	5317	5751	6220
	3 I absorbée	(A)	4.72	5.24	5.73	6.21	6.66	7.09	7.51	7.90	8.27
40	1 P frigorifique	(Watt)	3301	4963	6824	8924	11302	14000	17055	20509	24401
	2 P absorbée	(W)	2440	3105	3703	4246	4748	5222	5682	6140	6611
	3 I absorbée	(A)	4.50	5.17	5.81	6.43	7.03	7.61	8.16	8.70	9.22
50	1 P frigorifique	(Watt)		3215	4861	6663	8663	10899	13412	16241	19427
	2 P absorbée	(W)		2753	3535	4240	4882	5473	6028	6560	7081
	3 I absorbée	(A)		4.94	5.73	6.49	7.24	7.97	8.67	9.35	10.0
60	1 P frigorifique	(Watt)			2873	4370	5981	7748	9709	11905	14375
	2 P absorbée	(W)			3026	3942	4772	5530	6228	6881	7502
	3 I absorbée	(A)			5.50	6.41	7.30	8.17	9.02	9.85	10.7

1 = cooling capacity 2 = power input 3 = current 4 = condensing temperature 5 = evaporating temperature

Nota : Tecumseh se réserve le droit de modifier les informations contenues dans ce document sans préavis.
Note : Tecumseh reserves the right to change information contained in this document without notification.

© 2020 Tecumseh Products Company
All rights reserved



Tecumseh

TAG4553Z	Tension TZ : 400V 3~ 50Hz / 440V 3~ 60 Hz
-----------------	--

Les performances sont données dans les conditions EN12900 :	Gaz aspirés :	20.0 °C
Condition Dew	Sous refroidissement :	0.0 K
The performance data are in EN12900 conditions :	Return gas :	20.0 °C
Dew Condition	Subcooling :	0.0 K

© 2020 Tecumseh Products Company
All rights reserved

50 Hz R448A (*)

N°2865

4 T condensation	5 T évaporation	(°C)	-25	-20	-15	-10	-5	0	5	10	15
30	1 P frigorifique	(Watt)	3133	4476	6117	8108	10500	13345	16693	20596	25104
	2 P absorbée	(W)	1858	2196	2514	2812	3095	3363	3619	3865	4105
	3 I absorbée	(A)	3.78	4.20	4.62	5.03	5.43	5.82	6.19	6.55	6.87
40	1 P frigorifique	(Watt)		3375	4810	6526	8572	11001	13862	17209	21091
	2 P absorbée	(W)		2175	2584	2968	3331	3674	4000	4311	4608
	3 I absorbée	(A)		4.16	4.70	5.23	5.75	6.26	6.76	7.23	7.69
50	1 P frigorifique	(Watt)			3507	4966	6685	8717	11112	13921	17195
	2 P absorbée	(W)			2518	3016	3487	3932	4355	4757	5141
	3 I absorbée	(A)			4.64	5.31	5.97	6.61	7.25	7.86	8.46
60	1 P frigorifique	(Watt)				3457	4869	6523	8470	10761	13448
	2 P absorbée	(W)				2900	3505	4081	4628	5148	5645
	3 I absorbée	(A)				5.23	6.04	6.84	7.62	8.39	9.14

60 Hz R448A (*)

N°2865

4 T condensation	5 T évaporation	(°C)	-25	-20	-15	-10	-5	0	5	10	15
30	1 P frigorifique	(Watt)	3997	5676	7654	9977	12691	15842	19476	23639	28377
	2 P absorbée	(W)	2366	2818	3240	3642	4034	4425	4825	5245	5693
	3 I absorbée	(A)	4.16	4.62	5.08	5.53	5.98	6.40	6.81	7.20	7.56
40	1 P frigorifique	(Watt)		4276	6075	8153	10556	13328	16516	20166	24324
	2 P absorbée	(W)		2752	3295	3799	4273	4727	5171	5614	6067
	3 I absorbée	(A)		4.58	5.17	5.75	6.33	6.89	7.43	7.96	8.46
50	1 P frigorifique	(Watt)			4406	6237	8325	10717	13457	16593	20170
	2 P absorbée	(W)			3151	3813	4426	4999	5542	6065	6579
	3 I absorbée	(A)			5.11	5.84	6.56	7.27	7.97	8.65	9.31
60	1 P frigorifique	(Watt)				4297	6070	8079	10370	12990	15983
	2 P absorbée	(W)				3535	4343	5091	5790	6450	7079
	3 I absorbée	(A)				5.75	6.64	7.52	8.38	9.23	10.1

1 = cooling capacity 2 = power input 3 = current 4 = condensing temperature 5 = evaporating temperature

(*) Veuillez vous référer strictement aux Recommandations d'Utilisation et Bulletins Marketing Tecumseh du fait de la température de reflux élevée pour les applications LBP.

(*) Due to very high discharge temperature especially on LBP conditions, please strictly refer to Tecumseh Guidelines & Marketing Bulletin when using this refrigerant.

Nota : Tecumseh se réserve le droit de modifier les informations contenues dans ce document sans préavis.

Note : Tecumseh reserves the right to change information contained in this document without notification.



Tecumseh

TAG4553Z	Tension TZ : 400V 3~ 50Hz / 440V 3~ 60 Hz
-----------------	--

Les performances sont données dans les conditions EN12900 :	Gaz aspirés :	20.0 °C
Condition Dew	Sous refroidissement :	0.0 K
The performance data are in EN12900 conditions :	Return gas :	20.0 °C
Dew Condition	Subcooling :	0.0 K

© 2020 Tecumseh Products Company
All rights reserved

50 Hz R449A (*)

N°2258

4 T condensation	5 T évaporation	(°C)	-25	-20	-15	-10	-5	0	5	10	15
30	1 P frigorifique	(Watt)	3133	4476	6117	8108	10500	13345	16693	20596	25104
	2 P absorbée	(W)	1858	2196	2514	2812	3095	3363	3619	3865	4105
	3 I absorbée	(A)	3.78	4.20	4.62	5.03	5.43	5.82	6.19	6.55	6.87
40	1 P frigorifique	(Watt)		3375	4810	6526	8572	11001	13862	17209	21091
	2 P absorbée	(W)		2175	2584	2968	3331	3674	4000	4311	4608
	3 I absorbée	(A)		4.16	4.70	5.23	5.75	6.26	6.76	7.23	7.69
50	1 P frigorifique	(Watt)			3507	4966	6685	8717	11112	13921	17195
	2 P absorbée	(W)			2518	3016	3487	3932	4355	4757	5141
	3 I absorbée	(A)			4.64	5.31	5.97	6.61	7.25	7.86	8.46
60	1 P frigorifique	(Watt)				3457	4869	6523	8470	10761	13448
	2 P absorbée	(W)				2900	3505	4081	4628	5148	5645
	3 I absorbée	(A)				5.23	6.04	6.84	7.62	8.39	9.14

60 Hz R449A (*)

N°2258

4 T condensation	5 T évaporation	(°C)	-25	-20	-15	-10	-5	0	5	10	15
30	1 P frigorifique	(Watt)	3997	5676	7654	9977	12691	15842	19476	23639	28377
	2 P absorbée	(W)	2366	2818	3240	3642	4034	4425	4825	5245	5693
	3 I absorbée	(A)	4.16	4.62	5.08	5.53	5.98	6.40	6.81	7.20	7.56
40	1 P frigorifique	(Watt)		4276	6075	8153	10556	13328	16516	20166	24324
	2 P absorbée	(W)		2752	3295	3799	4273	4727	5171	5614	6067
	3 I absorbée	(A)		4.58	5.17	5.75	6.33	6.89	7.43	7.96	8.46
50	1 P frigorifique	(Watt)			4406	6237	8325	10717	13457	16593	20170
	2 P absorbée	(W)			3151	3813	4426	4999	5542	6065	6579
	3 I absorbée	(A)			5.11	5.84	6.56	7.27	7.97	8.65	9.31
60	1 P frigorifique	(Watt)				4297	6070	8079	10370	12990	15983
	2 P absorbée	(W)				3535	4343	5091	5790	6450	7079
	3 I absorbée	(A)				5.75	6.64	7.52	8.38	9.23	10.1

1 = cooling capacity 2 = power input 3 = current 4 = condensing temperature 5 = evaporating temperature

(*) Veuillez vous référer strictement aux Recommandations d'Utilisation et Bulletins Marketing Tecumseh du fait de la température de reflux élevée pour les applications LBP.

(*) Due to very high discharge temperature especially on LBP conditions, please strictly refer to Tecumseh Guidelines & Marketing Bulletin when using this refrigerant.

Nota : Tecumseh se réserve le droit de modifier les informations contenues dans ce document sans préavis.

Note : Tecumseh reserves the right to change information contained in this document without notification.