

DECINA

ISLE MKII FREESTANDING SPA

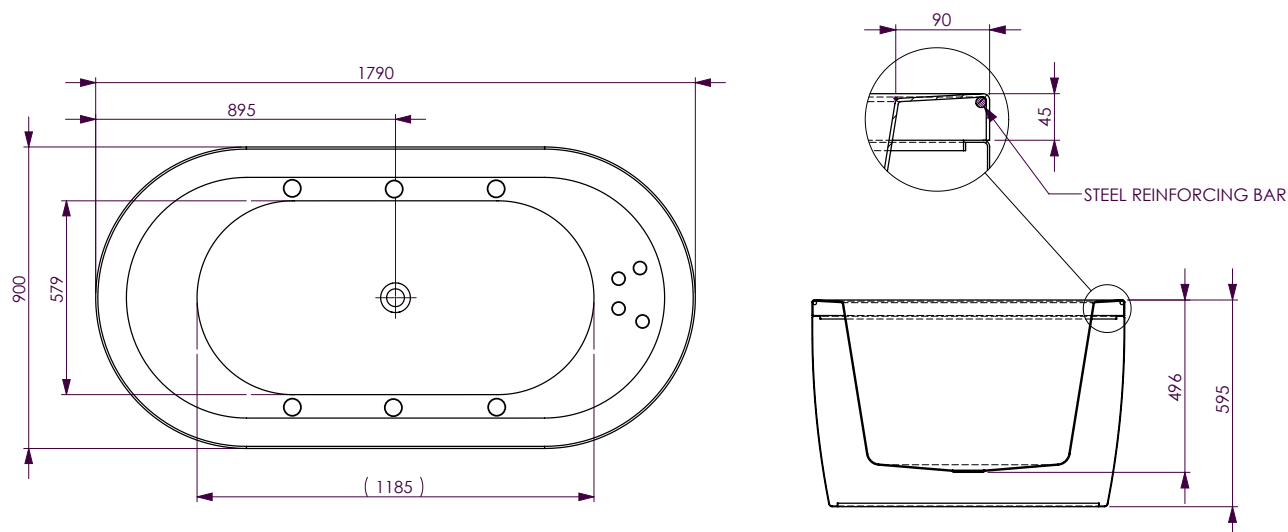

Flush air button



Flush air control



Flush centro jet



Flush mini jet

Dimensions are nominal measurements only.

SPECIFICATIONS

Recommended use:	Domestic, hotel, commercial.
Material:	Acrylic
Overflow	No
Plug and waste	40mm plug and waste.
Colour availability	Bath: White Jets: Chrome
Pump Type	Auto Heat Pump
Controls	Air Button, Air Controls (x2)
No of Jets	10



CLEANING RECOMMENDATIONS

We recommend the use of soapy water or approved cleaners.

This product should not be cleaned with abrasive materials.

Damage caused by any improper treatment is not covered by the product warranty- refer to Warranty Conditions.

To see the complete DECINA range go to
www.reece.com.au/bathrooms

Disclaimer: Products in this specification manual must by regulation be installed by licensed and registered trade people. The manufacturer/distributor reserves the right to vary specifications or delete models from their range without prior notification. Dimensions are nominal measurements only. Dimensions and set-outs listed are correct at time of publication however the manufacturer/distributor takes no responsibility for printing errors.

Tech Page Version 2

DECINA
BATHROOMWARE
relaxing your senses

reece

DECINA





ISLE MKII FREESTANDING SPA

INSTALLATION INSTRUCTIONS

SKIRT REMOVAL

		
1. Begin at the skirt gap	2. Pull edge towards you to separate.	3. Gradually work your way anti-clockwise, peeling off the skirt.

BATH / SPA BATH INSTALLATION

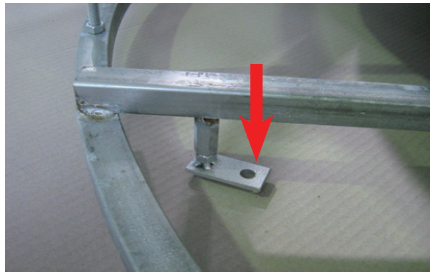





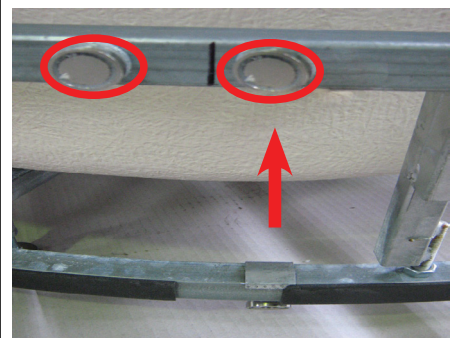

		
1. Fit waste and prepare the waste plumbing. If using an offset connector, Decina recommend a through connector.	2. Place bath in its final position for height adjustment. Please note that the bath weighs 100Kgs and the Spa weighs 125Kgs so adequate provisions for safe lifting must be made.	3. For the neatest appearance, height from the floor to the underside of the rim should be between 535mm and 538mm. This height may be more, but the result will be a larger gap between the skirt and the floor.
		
4. Adjust the four support feet to achieve the correct height	5. Adjust the two holding feet to match the correct height and align in a convenient location for drilling	6. Fix to the floor with appropriate fasteners

Plumbers, please ensure a copy of the installation instructions is left with the end user for future reference

DECINA

ISLE MKII FREESTANDING SPA

SKIRT INSTALLATION

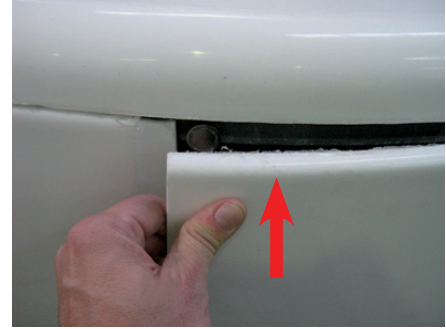
		
<p>1. Choose the position of the skirt join and place the clipped magnet on the bottom rail, below the fixed magnets on the right hand side. Place the second clipped magnet on the opposite side of the bath to the first.</p>	<p>2. Bring the recessed end of the skirt toward the bath so the top lip fits tightly under the bath rim but above the bath frame.</p>	<p>3. The edge should be located close to but not over the second magnet.</p>
		
<p>4. Work around the bath in a clockwise direction, pushing the skirt to the bath. Ensure that the top lip remains at the correct height.</p>	<p>5. Leave the end slightly open, checking to ensure the clipped magnet will line up to the steel square on the skirt.</p>	<p>6. Push the joint to the bath and continue working in a clockwise direction, ensuring the lip height remains correct.</p>
		
<p>7. Push the joint to the bath and continue working in a clockwise direction, ensuring the lip height remains correct.</p>	<p>8. Continue to the end of the second half of the skirt.</p>	<p>9. Push the end against the bath and inspect the skirt to see if it is sitting correctly the whole way around.</p>

Plumbers, please ensure a copy of the installation instructions is left with the end user for future reference