

Owner's Guide and Installation Instructions



*Continuous Flow
Gas Water Heater
874, 876 series
B28 models*



*This water heater must be installed and serviced by a qualified person.
Please leave this guide with the householder.*

 **Warning:** Upon completion of the installation and commissioning of the water heater, leave this guide with the householder or a responsible officer. **DO NOT** leave this guide inside of the cover of the water heater, as it may interfere with the safe operation of the water heater or ignite when the water heater is turned on.

An electronic copy of these Owner's Guide and Installation Instructions can be downloaded from rheem.com.au.

Rheem Australia Pty Ltd is the supplier of the Rheem range of gas continuous flow water heaters, manufactured in Japan by Paloma Co., Ltd., a world leader in water heater technology and manufacture.

PATENTS

This water heater may be protected by one or more patents or registered designs in the name of Rheem Australia Pty Ltd or Paloma Co., Ltd.

TRADEMARKS

® Registered trademark of Rheem Australia Pty Ltd.
™ Trademark of Rheem Australia Pty Ltd.

Note: Every care has been taken to ensure accuracy in preparation of this publication. No liability can be accepted for any consequences, which may arise as a result of its application.

CONTENTS

HOUSEHOLDER

This booklet contains important information about your new water heater, including terms of the Rheem warranty.

We recommend you read pages 7 to 19,
and the terms of the Rheem warranty on pages 4 to 6.

The other pages are intended for the installer but may be of interest.

Warranty	4
Safety, Warnings, Installation Notes	7
About Your Water Heater	10
Maintenance Requirements.....	15
Water Supplies.....	16
Save A Service Call	17
Installation – Water Heater	20
Connections – Plumbing	31
Connections – Electrical.....	33
EZ LINK System Dual Installation.....	35
Commissioning.....	40
Draining The Water Heater	49

RHEEM AUSTRALIA PTY LTD, A.B.N. 21 098 823 511

www.rheem.com.au

For Service Telephone 131 031 AUSTRALIA

RHEEM GAS CONTINUOUS FLOW WATER HEATER WARRANTY – AUSTRALIA ONLY

GAS CONTINUOUS FLOW WATER HEATERS 874, 876 SERIES B28 MODELS

1. THE RHEEM WARRANTY – GENERAL

- 1.1 This warranty is given by Rheem Australia Pty Limited ABN 21 098 823 511 of 1 Alan Street, Rydalmere New South Wales, the suppliers of Rheem gas continuous flow water heaters.
- 1.2 Rheem offer a trained and qualified national service network who will repair or replace components at the address of the water heater subject to the terms of the Rheem warranty. Rheem Service, in addition can provide preventative maintenance and advice on the operation of your water heater. The Rheem Service contact number is 131031, with Contact Centre personnel available 24 hours, 7 days a week to take your call and if necessary to arrange a service call for during normal working hours Monday to Friday (hours subject to change).
- 1.3 For details about this warranty, you can contact us on 131031 or by email at warrantyenquiry@rheem.com.au (not for service bookings).
- 1.4 The terms of this warranty and what is covered by it are set out in sections 2 and 3 and apply to water heaters manufactured from the 1st April 2024.
- 1.5 If a subsequent version of this warranty is published, the terms of that warranty and what is covered by it will apply to water heaters manufactured after the date specified in the subsequent version.

2. TERMS OF THE RHEEM WARRANTY AND EXCLUSIONS TO IT

- 2.1 The decision of whether to repair or replace a faulty component is at Rheem's sole discretion.
- 2.2 If you require a call out and we find that the fault is not covered by the Rheem warranty, you are responsible for our standard call out charge. If you wish to have the relevant component repaired or replaced by Rheem, that service will be at your cost.
- 2.3 Where a failed component or cylinder is replaced under this warranty, the balance of the original warranty period will remain effective. The replacement does not carry a new Rheem warranty.
- 2.4 Where the water heater is installed outside the boundaries of a metropolitan area as defined by Rheem or further than 25 km from either a regional Rheem branch office or an Accredited Rheem Service Agent's office, the cost of transport, insurance and travelling between the nearest branch office or Rheem Accredited Service Agent's office and the installed site shall be the owner's responsibility.
- 2.5 Where the water heater is installed in a position that does not allow safe or ready access, the cost of that access, including the cost of additional materials handling and/or safety equipment, shall be the owner's responsibility. In other words, the cost of dismantling or removing cupboards, doors or walls and the cost of any special equipment to bring the water heater to floor or ground level or to a serviceable position is not covered by this warranty.
- 2.6 This warranty only applies to the original and genuine Rheem water heater in its original installed location and any genuine Rheem replacement parts.
- 2.7 The Rheem warranty does not cover faults that are a result of:
 - a) Accidental damage to the water heater or any component (for example: (i) Acts of God such as floods, storms, fires, lightning strikes and the like; and (ii) third party acts or omissions).
 - b) Misuse or abnormal use of the water heater.
 - c) Installation not in accordance with the Owner's Guide and Installation Instructions or with relevant statutory and local requirements in the State or Territory in which the water heater is installed.
 - d) Connection at any time to a water supply that does not comply with the water supply guidelines as outlined in the Owner's Guide and Installation Instructions.

RHEEM GAS CONTINUOUS FLOW WATER HEATER WARRANTY – AUSTRALIA ONLY

GAS CONTINUOUS FLOW WATER HEATERS 874, 876 SERIES B28 MODELS

- e) Repairs, attempts to repair or modifications to the water heater by a person other than Rheem Service or a Rheem Accredited Service Agent.
 - f) Faulty plumbing or faulty gas or power supply.
 - g) Failure to maintain the water heater in accordance with the Owner's Guide and Installation Instructions.
 - h) Transport damage.
 - i) Fair wear and tear from adverse conditions (for example, corrosion).
 - j) Cosmetic defects.
 - k) Ice formation in the waterways of a water heater: where the electricity supply has been switched off or has failed and the water heater has not been drained in accordance with the instructions; or due to an ambient temperature below -20°C (including wind chill factor).
- 2.8 Subject to any statutory provisions to the contrary, this warranty excludes any and all claims for damage to furniture, carpet, walls, foundations or any other consequential loss either directly or indirectly due to leakage from the water heater, or due to leakage from fittings and/ or pipe work of metal, plastic or other materials caused by water temperature, workmanship or other modes of failure.
- 2.9 If the water heater is not sized to supply the hot water demand in accordance with the guidelines in the Rheem water heater literature, any resultant fault will not be covered by the Rheem warranty.

3. WHAT IS COVERED BY THE RHEEM WARRANTY FOR THE WATER HEATERS DETAILED IN THIS DOCUMENT

- 3.1 Rheem will repair or replace a faulty component of your water heater if it fails to operate in accordance with its specifications as follows:

What components are covered	The period from the date of installation in which the fault must appear in order to be covered	What coverage you receive
All components	Year 1	Repair and/or replacement of the faulty component, free of charge, including labour.
All components (only if the water heater is installed in a single-family domestic dwelling)	Years 2 & 3	Repair and/or replacement of the faulty component, free of charge, including labour.
The heat exchanger (only if the water heater is installed in a single-family domestic dwelling)	Years 4 to 15	Replacement heat exchanger, free of charge. Installation and repair labour costs are the responsibility of the owner.

RHEEM GAS CONTINUOUS FLOW WATER HEATER WARRANTY – AUSTRALIA ONLY

GAS CONTINUOUS FLOW WATER HEATERS 874, 876 SERIES B28 MODELS

4. ENTITLEMENT TO MAKE A CLAIM UNDER THIS WARRANTY

- 4.1 To be entitled to make a claim under this warranty you need to:
- a) Be the owner of the water heater or have consent of the owner to act on their behalf.
 - b) Contact Rheem Service without undue delay after detection of the defect and, in any event, within the applicable warranty period.
- 4.2 You are **not** entitled to make a claim under this warranty if your water heater:
- a) Does not have its original serial numbers or rating labels.
 - b) Is not installed in Australia.

5. HOW TO MAKE A CLAIM UNDER THIS WARRANTY

- 5.1 If you wish to make a claim under this warranty, you need to:
- a) Contact Rheem on 131031 in Australia and provide owner's details, address of the water heater, a contact number and date of installation of the water heater or if that's unavailable, the date of manufacture and serial number (from the rating label on the water heater).
 - b) Rheem will arrange for the water heater to be tested and assessed on-site.
 - c) If Rheem determines that you have a valid warranty claim, Rheem will repair or replace the water heater in accordance with this warranty.
- 5.2 Any expenses incurred in the making of a claim under this warranty will be borne by you.

6. THE AUSTRALIAN CONSUMER LAW

- 6.1 In Australia, our goods come with guarantees that cannot be excluded under the Australian Consumer Law. You are entitled to a replacement or refund for a major failure and for compensation for any other reasonably foreseeable loss or damage. You are also entitled to have the goods repaired or replaced if the goods fail to be of acceptable quality and the failure does not amount to a major failure.
- 6.2 The Rheem warranty (set out above) is in addition to any rights and remedies that you may have under the Australian Consumer Law.

SAFETY, WARNINGS, INSTALLATION NOTES

It is important you read the following safety and warnings information.

SAFETY AND WARNINGS

- The water heater heats the water to the preset outlet temperature setting if a temperature controller is not installed. The outlet temperature setting can be up to 75°C for an 874 series water heater or up to 50°C for an 876 series water heater. If an 874 series water heater is installed as part of a solar water heater system, the system can deliver water at temperatures from 58°C up to 80°C and possibly higher depending upon the model of solar water heater installed.

These temperatures from an 874 series water heater are sufficiently hot to cause severe scalding. Water at this temperature may have been plumbed to fixtures where water hotter than 50°C is allowed, such as the kitchen and laundry.

Refer to:

- [“How Hot Should the Water Be?”](#) on page 11, and
- [“Hotter Water Increases the Risk of Scald Injury”](#) on page 11.
- This water heater is only intended to be operated by persons who have the experience or the knowledge and the capabilities to do so.
- This water heater is not intended to be operated by persons with reduced physical, sensory or mental capabilities i.e. the infirm, or by children. Children should be supervised to ensure they do not interfere with or play with or at the water heater.
- If the power supply cord or plug is damaged, it must be replaced by a qualified person in order to avoid a hazard. The power supply cord and plug must be replaced with a genuine replacement part available from Rheem. Phone Rheem Service or their nearest Accredited Service Agent to arrange for an inspection.
- The power lead from the water heater must be plugged into a weatherproof electrical outlet. Take care not to touch the power plug with wet hands.
- The water heater uses 220 - 240 V a.c. electrical power for operation of the control systems and the combustion fan. The removal of the front panel will expose 220 - 240 V a.c. wiring. It must only be removed by a qualified person. Do not operate the water heater with the front panel removed.
- This water heater is supplied with temperature sensors, a FlameSafe® protection system and a pressure relief valve. These devices must not be tampered with or removed. The water heater must not be operated unless each of these devices is fitted and is in working order.

The Rheem warranty may not cover faults if safety devices or the relief valve are tampered with or if the installation is not in accordance with these instructions.

- Temperature controllers **must not** be fitted to this water heater (874 series) if it is installed as an in-series gas booster with a solar water heater system because water at a temperature much higher than the controller setting can be delivered. If a solar water heater is installed to an existing water heater installation, then all controllers **must be** disconnected and removed.
- For continued safety of this water heater it must be installed, operated and maintained in accordance with the Owner’s Guide and Installation Instructions.
- Servicing of the water heater must only be carried out by qualified personnel. Phone Rheem Service or their nearest Accredited Service Agent.
- Do not modify this water heater.
- Switch off the electrical supply at the power outlet to the water heater prior to performing general maintenance. This will prevent the water heater from operating while you clean or spray around the water heater.

Refer to [“General Maintenance”](#) on page 15 for additional information.

- Do not spray **aerosols** in the vicinity of this water heater while it is in operation. Propellants and gases in many aerosol sprays contain hydrocarbons which are flammable. Gases from aerosol sprays may also become corrosive when drawn into a flame.
- Do not use or store **flammable materials** in or near this water heater. Flammable liquids (such as petrol), combustible materials (such as newspapers) and similar articles must be kept well away from the water heater and the flue terminal.
- Do not store **swimming pool chemicals, household cleaners, etc.**, near the water heater.
- Do not place articles on or against this water heater, or in contact with the flue terminal. Ensure the flue terminal is not obstructed in any way at any time.
- Do not use Propane / Butane gas mixtures in a Propane model. A Propane model is designed to operate on Propane only. The use of Propane / Butane mixture, such as automotive LP gas fuel, in a Propane model is unsafe and can cause damage to the water heater.
- The water heater has a frost protection system to protect against damage by preventing ice forming in the waterways of the water heater, in the event of freezing conditions occurring. The frost protection system will be rendered inoperable if electrical power is not available at the water heater. If it is necessary to switch the power off to the water heater and there is a risk of freezing, then it is necessary to drain the water heater.



Refer to:

- [“Frost Protection”](#) on page 12, and
- [“Draining the Water Heater”](#) on page 13.

INSTALLATION NOTES

This water heater must be installed:

- by a qualified person,
- in accordance with the installation instructions,
- in compliance with the Plumbing Code of Australia (PCA) and Plumbing Standard AS/NZS 3500.4,
 - This water heater is designed for outdoor installation only.
 - This water heater is intended to be permanently connected to the water mains and not connected by a hose-set. A braided flexible hose or semi-flexible connector may be used for connection to the water heater, where permitted by AS/NZS 3500.4.
- in compliance with the Gas Installations Standard AS/NZS 5601.1,
 - The Gas installations Standard AS/NZS 5601.1 places limitations on the location of a gas water heater within a covered area.

Refer to [“Installation within a Covered Area”](#) on page 22.

- in compliance with all local codes and regulatory authority requirements.

Installation and commissioning requirements and details for the installing plumber and licensed electrical worker are contained on [pages 20 to 49](#).

Mains pressure water supply

The water heater is designed to operate at mains pressure by connecting directly to the mains water supply.

The maximum mains water supply pressure for the water heater is 1,000 kPa. If the mains supply pressure in your area exceeds 1,000 kPa, an approved pressure limiting valve that does not have non-return valve characteristics (such as an RMC PSL series valve) must be installed.

A minimum water supply pressure of 120 kPa is required to achieve the rated flow and performance of the water heater.

Refer to [“Mains Water Supply”](#) on page 22 for additional information.

Mounting of the water heater

This water heater must be installed vertically upright with the water, gas and power connections on the underside, pointing toward the ground. The back of the water heater can be either against a wall or supported by a frame. The water heater must be well secured to the wall or frame using two fasteners, suitable for the wall or frame type, each at the top and bottom of the unit. Refer to the [note](#) on page 21 for additional information.

Alternatively, the water heater can be installed recessed into a wall, using a proprietary made recess box from Rheem for such an installation. Refer to the installation instructions which accompany the recess box kit for the dimensions of the space required and information on its installation.

Refer also to [“Recess Installation”](#) on page 22.

ABOUT YOUR WATER HEATER

WATER HEATER APPLICATION

This water heater is designed for use in a single family domestic dwelling for the purpose of heating potable water. Its use in an application other than this may shorten its life.

MODEL TYPE

The Rheem® gas continuous flow water heater model you have chosen is for outdoor installation only.

The water heater has a maximum preset outlet temperature setting of:

- 874 series 75°C
- 876 series 50°C

Note: The 876 series water heater is marked “THIS APPLIANCE DELIVERS WATER NOT EXCEEDING 50°C IN ACCORDANCE WITH AS 3498” on the front panel.

- This model **must not** be installed as an in-series gas booster to a solar water heater, as water temperature greater than 50°C can be delivered from the water heater contravening its compliance to AS 3498.



WATER HEATER OPERATION

The water heater operates automatically, heating water as it passes through the water heater. When a hot tap is opened, the gas burners ignite to provide immediate heating of the water. The heat produced by the burner is transferred to the water through the heat exchanger. The water is heated to a constant temperature by the automatic adjustment of the gas supply to the burner to suit the water flow rate. The gas burners extinguish when the hot tap is closed.

Automatic safety controls are fitted to the water heater to provide safe and efficient operation. In the event of a power supply interruption, such as a blackout or brownout, when power is restored to the water heater, it will initialise and be ready for use.

USER TEMPERATURE CONTROL

Temperature Controllers

The Rheem 874 and 876 series may be installed with one or more user adjustable Standard temperature controllers, which allow you to choose the most suitable water temperature of the delivered water from the outlet of the water heater for your hot water needs. They are the Kitchen controller, Bathroom 1 controller and the Bathroom 2 controller.

Temperature controllers are only suitable for either a single water heater installation or a dual water heater installation using the EZ Link system. They are not suitable if multiple water heaters are manifolded together. Other manufacturers' controllers are not suitable to and cannot be installed with this water heater.

⚠ Warning: Temperature controllers **must not** be fitted to this water heater (874 series) if it is installed as an in-series gas booster with a solar water heater system because water at a temperature much higher than the controller setting can be delivered. If a solar water heater is installed to an existing water heater installation, then all controllers **must be** disconnected and removed.

Refer to the Rheem website for the Owner's Guide and Installation Instructions for the Standard Rheem Controllers. Visit www.rheem.com.au/rheem/help#guides.

HOW HOT SHOULD THE WATER BE?

If a controller is not installed, the water heater heats the water to the preset outlet temperature setting. The factory preset outlet temperature setting is:

- 874 series 60°C
- 876 series 50°C

Note: The preset outlet temperature setting of this water heater cannot be adjusted by the householder. The setting can only be adjusted by the installer, Rheem Service or their nearest Accredited Service Agent.

Note: Australian Standard AS 3498 requires that a water heater provides the means to inhibit the growth of Legionella bacteria in potable water. When the 874 series water heater is used as an in-series booster for a solar water heater it can satisfy the AS 3498 requirements provided it is energised, the booster preset outlet temperature setting is at least 70°C, and that a remote temperature controller is not used.

Warning: Temperature controllers **must not** be fitted to this water heater (874 series) if it is installed as an in-series gas booster with a solar water heater system because water at a temperature much higher than the controller setting can be delivered. If a solar water heater is installed to an existing water heater installation, then all controllers **must be** disconnected and removed.

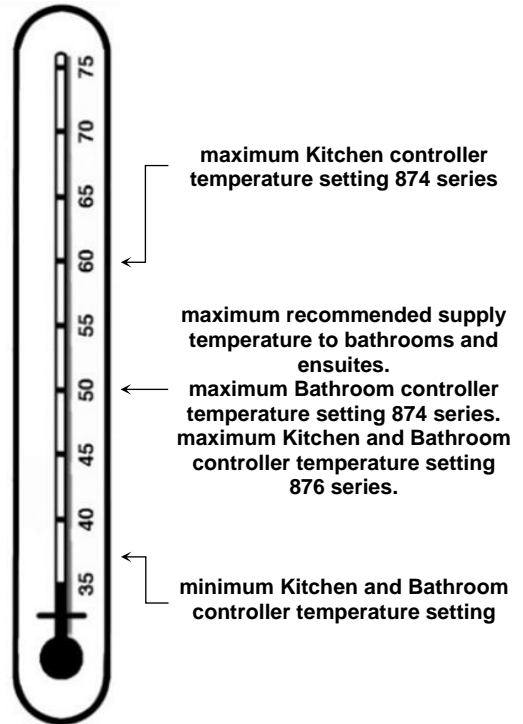

If this water heater is installed as part of a solar water heater system, the system can deliver water at temperatures from 58°C up to 80°C and possibly higher depending upon the model of solar water heater installed.

HOTTER WATER INCREASES THE RISK OF SCALD INJURY

Warning: This water heater can deliver water at temperatures which can cause scalding.

Check the water temperature before use, such as when entering a shower or filling a bath or basin, to ensure it is suitable for the application and will not cause scald injury.

874 series – Hot Water Outlet

Depending upon its preset outlet temperature setting, an 874 series water heater can deliver hot water at a temperature up to 75°C when no temperature controller is installed and 60°C when a temperature controller is installed. These temperatures are sufficiently hot to cause severe scalding. A model used as a booster to a solar water heater could on occasion deliver hot water exceeding 75°C. Water at these temperatures may have been plumbed to fixtures where water hotter than 50°C is allowed, such as the kitchen and laundry.

We recommend and it may be required by regulations that an approved temperature limiting device be fitted into the hot water pipe work to the bathroom and ensuite when an 874 series water heater is installed. This will keep the water temperature below 50°C at the bathroom and ensuite. The risk of scald injury will be reduced and if no controllers are installed and the preset outlet temperature setting has not been adjusted below 55°C or if a Kitchen controller is installed, still allow hotter water to the kitchen and laundry.

876 series – 50°C Limited Outlet

An 876 series water heater delivers water not exceeding 50°C in accordance with AS 3498. The risk of scald injury will be reduced.

There is no need to fit a temperature limiting device to satisfy the requirements of the Plumbing Code of Australia if an 876 series water heater is installed and serving an application where 50°C is the maximum permissible hot water temperature at the outlet of a fixture used primarily for personal hygiene, such as in a bathroom or ensuite.

GAS BOOSTING FOR A SOLAR WATER HEATER

The 874 series water heater may be installed as an in-series gas booster to a solar water heater.

Water stored in the solar storage tank passes through the in-series gas booster when a hot tap is opened. The in-series gas booster is for heating water at times of low solar energy gain, such as during cloudy or rainy weather, or during colder months.

The in-series gas booster operates automatically. When the solar heated water temperature is below 58°C, the in-series gas booster heats the water to its preset outlet temperature setting.

Solar heated water can reach temperatures up to 70°C to 80°C for a Premier Loline and Loline pumped system and possibly higher for a Hiline and Premier Hiline thermosiphon system. When the solar heated water temperature is 58°C or higher, the flow passes through the in-series gas booster without boosting.

For information relating to the function and operation of the solar water heater, refer to the Owner's Guide and Installation Instructions supplied with the solar water heater.

REDUCED HOT WATER FLOW WHEN HEAT EXCHANGER IS COLD

At a cold start-up, i.e. when the water heater has not operated for some time (which is most often first thing in the morning), the initial flow of hot water may be reduced for a period of 5-10 seconds while the heat exchanger warms up. **This is both an energy and water saving feature of this water heater.** Once the heat exchanger has warmed up the hot water flow will increase and remain at normal flow levels. This feature will only occur at a cold start-up and not when the heat exchanger is already warm from a recent use of hot water.

FROST PROTECTION

The water heater has a frost protection system. The frost protection system will protect the water heater from damage, by preventing ice forming in the waterways of the water heater, in the event of freezing conditions occurring.

Notes

- The frost protection system will be rendered inoperable if electrical power is not available at the water heater. Damage caused by freezing due to the unavailability of power at the water heater is not covered by the Rheem warranty (refer to [“Terms of the Rheem Warranty”](#) on page 4).
- If it is necessary to switch the power off to the water heater and there is a risk of freezing, then it is necessary to drain the water heater (refer to [“Draining the Water Heater”](#) on page 13).
- Pipe work to and from the water heater must be adequately insulated to prevent freezing.
- The water heater is not suitable for installation in areas where the ambient temperature falls below -20°C (including wind chill factor).
- Refer to [“Terms of the Rheem Warranty”](#) on page 4.

PRECAUTIONS

The water heater must be maintained in accordance with the Owner's Guide and Installation Instructions. Refer to [“General Maintenance”](#) on page 15 and [“Major Service Every Five Years”](#) on page 15.

If this water heater is to be used where an uninterrupted hot water supply is necessary for your application or business you should ensure that you have back-up redundancy within the hot water system design. This should ensure the continuity of hot water supply in the event that this water heater were to become inoperable for any reason. We recommend you seek advice from a plumber or specifier about your needs and building back-up redundancy into your hot water supply system.

TO TURN OFF THE WATER HEATER

If it is necessary to turn off the water heater:

- Turn off the controller(s) (if fitted) by pressing the on / off (⏻) button.
The on / off operating light will go out and the priority light, if it is on, will go out.
- Switch off the electrical supply at the power outlet to the water heater if there is no risk of freezing conditions occurring (refer to note below).
- Close the gas isolation valve at the inlet to the water heater.
- Close the cold water isolation valve at the inlet to the water heater.

Note: If there is a risk of freezing conditions, the electrical supply to the water heater should not be switched off unless the water heater is drained, otherwise damage could result (refer to [“Frost Protection”](#) on page 12 and [“Draining the Water Heater”](#) on page 13).

TO TURN ON THE WATER HEATER

- Screw in the drain plugs at the cold water inlet and hot water outlet of the water heater if the water heater has been drained.
- Open all of the hot taps in the house (don't forget the shower).
- Open the cold water isolation valve fully at the inlet to the water heater.
Air will be forced out of the taps.
- Close each tap as water flows freely from it.
- Open the gas isolation valve fully at the inlet to the water heater.
- Plug in the power supply cord at the power outlet.
- Switch on the electrical supply at the power outlet to the water heater.
- Turn on a controller, if one is fitted, by pressing the on / off (⏻) button.
The on / off operating light and the priority light will both glow.

The water heater will operate automatically when you open a hot tap.

DRAINING THE WATER HEATER

- Turn off the water heater (refer to [“Turn Off The Water Heater”](#) on page 13).
- Open a hot tap (preferably the shower outlet).
- Unscrew the two drain plugs, one each at the cold water inlet and hot water outlet (874 series model) or 50°C limited outlet (876 series model), on the underside of the water heater.

Water will drain from the water heater.

- When water stops flowing from the water heater, close the hot tap.

Note: It is recommended not to screw the drain plugs back in, until the water heater is to be turned on again.

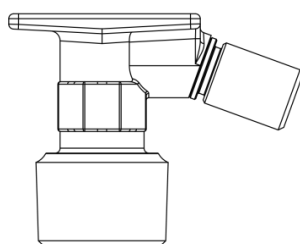

HOT WATER OUTLET

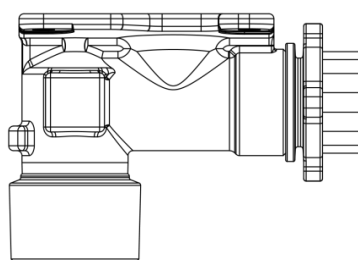

COLD WATER INLET

CIRCULATED HOT WATER FLOW AND RETURN SYSTEM

A Rheem 874B28 model continuous flow water heater can be installed as part of a circulated hot water flow and return system in a building. Refer to [“Circulated Hot Water Flow and Return System”](#) on page 25 for further information and notes on this type of installation.

GOING ON HOLIDAYS

If you are going on holidays, it is not necessary to turn the water heater off. If it is necessary to turn off the water heater, refer to [“To Turn Off The Water Heater”](#) on page 13.

VICTORIAN CUSTOMERS

Notice to Victorian Customers from the Victorian Building Authority. This water heater must be installed by a licensed person as required by the Victorian Building Act 1993.

Only a licensed person will give you a Compliance Certificate, showing that the work complies with all the relevant Standards. Only a licensed person will have insurance protecting their workmanship for 6 years. Make sure you use a licensed person to install this water heater and ask for your Compliance Certificate.

DOES THE WATER CHEMISTRY AFFECT THE WATER HEATER?

The water heater is suitable for most public water supplies, however some water chemistries may have detrimental effects on the water heater, its components and fittings. Refer to [“Water Supplies”](#) on page 16.

If you are in a known harsh water area or you are not sure of your water chemistry, have your water checked against the conditions [described on page 16](#).

HOW LONG WILL THE WATER HEATER LAST?

The water heater is supported by a manufacturer’s warranty ([refer to page 4](#)). There are a number of factors that will affect the length of service the water heater will provide. These include but are not limited to the water chemistry, the water pressure, the water temperature (inlet and outlet) and the water usage pattern. Refer to [“Precautions”](#) on page 12.

MAINTENANCE REQUIREMENTS

GENERAL MAINTENANCE

General maintenance can be performed by the dwelling occupant. It is recommended general maintenance be conducted every six (6) months or more regularly as required.

Switch off the electrical supply at the power outlet to the water heater prior to performing general maintenance. This will prevent the water heater from operating while you clean or spray around the water heater. Switch on the electrical supply at the power outlet to the water heater when finished performing the general maintenance.

The general maintenance includes:

- The jacket of the water heater can be cleaned with a soft cloth and warm mild soapy water if required. Under no circumstances should abrasive materials or powders be used.
- Inspect around the air inlet, flue terminal and the water heater in general for plant growth.
 - Trim back any shrubs, bushes or other plants which have encroached around the water heater.

Plant growth across the air inlet and flue terminal can interfere with the performance of the water heater.
- Inspect around the water heater for infestations of insects, such as ants. Insects encroaching into or nesting in the water heater can interfere with the operation of the water heater and also damage components. The area around the water heater can be sprayed with insecticide to rid the area of insects.

⚠ Warning: Do not spray insecticide near the water heater while it is operating. Propellants in many insect sprays contain hydrocarbons which are flammable. Gases from aerosol sprays may also become corrosive when drawn into a flame.

- If necessary to rid the area of insects:
 - Ensure the electrical supply at the power outlet to the water heater has been switched off.
 - Spray the affected area, taking care not to spray into the air inlet or flue terminal or onto the surface of the water heater.
 - Wait a few minutes to allow any aerosol gases to dissipate before switching on the electrical supply at the power outlet to the water heater.

MAJOR SERVICE EVERY FIVE YEARS

For safe and efficient operation, it is recommended a major service be conducted on the water heater every five (5) years.

⚠ Warning: Servicing of a water heater must only be carried out by qualified personnel. Phone Rheem Service or their nearest Accredited Service Agent.

Note: The major service and routine replacement of any components, if required, are not included in the Rheem warranty. A charge will be made for this work. Only genuine replacement parts should be used on this water heater.

The major service includes the following actions:

- Check and if necessary adjust the gas pressure.
- Check the operation of and clean the burner.
- Check and clean the line strainer.
- Visually check the unit for any potential problems.
- Inspect all connections.

WATER SUPPLIES

This water heater must be installed in accordance with this advice to be covered by the Rheem warranty.

This water heater is manufactured to suit the water conditions of most public reticulated water supplies. However, there are some known water chemistries which can have detrimental effects on the water heater and its operation and / or life expectancy. If you are unsure of your water chemistry, you may be able to obtain information from your local water supply authority. This water heater should only be connected to a water supply which complies with these guidelines for the Rheem warranty to apply.

CHANGE OF WATER SUPPLY

The changing or alternating from one water supply to another can have a detrimental effect on the operation and / or life expectation of a heat exchanger in a continuous flow water heater.

Where there is a changeover from one water supply to another, e.g., a rainwater tank supply, bore water supply, desalinated water supply, public reticulated water supply or water brought in from another supply, then water chemistry information should be sought from the supplier or it should be tested to ensure the water supply meets the requirements given in these guidelines for the Rheem warranty to apply.

SATURATION INDEX

The saturation index (SI) is used as a measure of the water's corrosive or scaling properties. The saturation index figures stated are calculated using a water temperature of 80°C.

In a corrosive water supply, the water can attack copper parts and cause them to fail. Where the saturation index is less than -1.0, the water is very corrosive and the Rheem warranty does not apply to a copper heat exchanger in a continuous flow water heater.

In a scaling water supply calcium carbonate is deposited out of the water onto any hot metallic surface. Where the saturation index exceeds +0.80, the Rheem warranty does not apply to a copper heat exchanger in a continuous flow water heater.

Water which is scaling may be treated with a water softening device to reduce the saturation index of the water.

Refer to the [Saturation Index chart](#) on page 16.

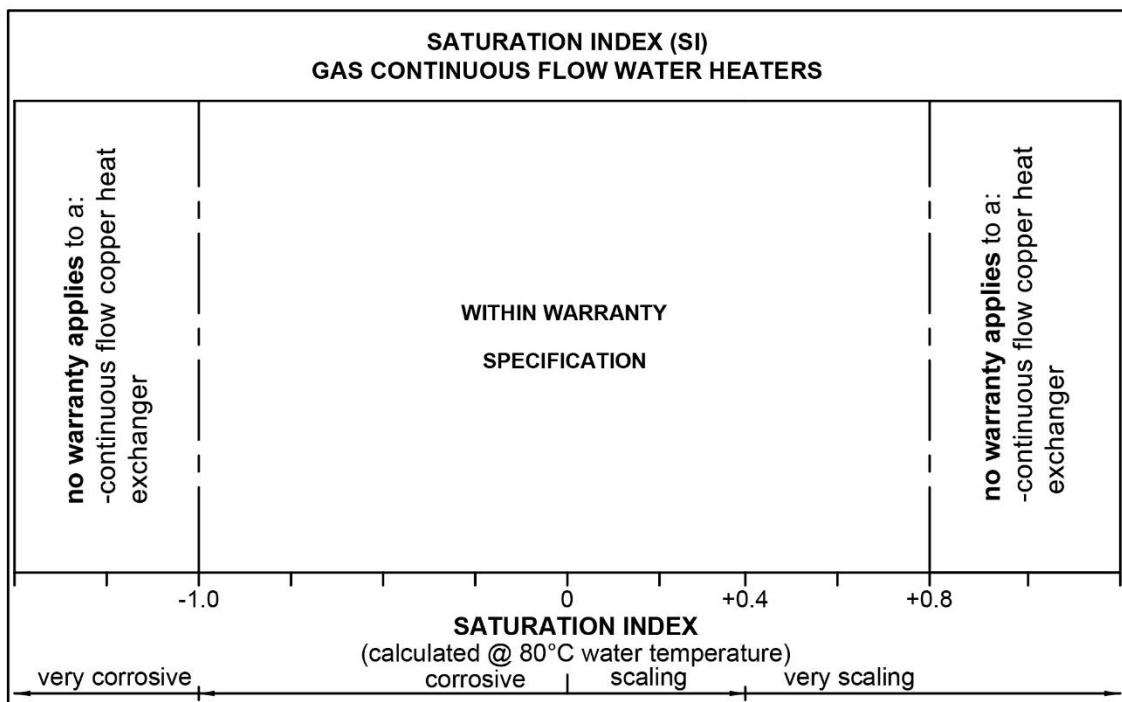

SAVE A SERVICE CALL

Check the items below before making a service call. You will be charged for attending to any condition or fault, which is not related to manufacture or failure of a part (refer to “[Terms of the Rheem Warranty](#)” on page 4).

NO DISPLAY ON THE CONTROLLER

- Is the controller turned on?
Press the on / off (⏻) button on the controller.
- Is the water heater plugged in and the power outlet switched on?
- Is power available in the house?
Try using another electrical appliance.

COLD WATER FROM THE HOT TAP

- Is the controller turned on?
Press the on / off (⏻) button on the controller.
- Close the hot tap, wait 10 seconds and open the hot tap again.
- Is the hot tap open enough?
The burners will not light if the flow rate is less than 1.5 L / min.
- Is the water heater plugged in and the power outlet switched on?
- Is power available in the house?
Try using another electrical appliance.
- Is the isolation valve in the gas line open?
- Is there a gas supply to the rest of the house?
Try lighting another gas appliance.
- Has the gas line been purged of air after installation?
Refer to a plumber.

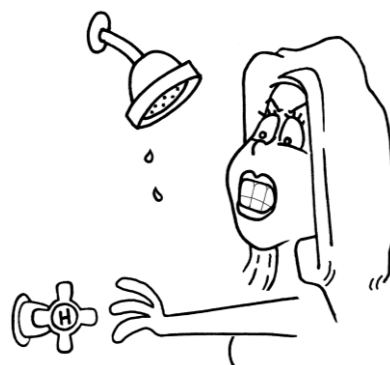

WATER IS TOO HOT OR NOT HOT ENOUGH

- Does the controller you are using have priority?
Refer to “Temperature Control” in the Owner’s Guide and Installation Instructions of the controllers.
Note: For an 876 series water heater, 50°C is the maximum available temperature setting.

NO WATER FROM THE HOT TAP

No flow of water from the hot tap may indicate a restriction in or failure of the cold water supply to the water heater. Check for water flow at other taps and that the cold water isolation valve ([refer to page 31](#)) is fully open.

REDUCED HOT WATER FLOW WHEN HEAT EXCHANGER IS COLD

At a cold start-up, i.e. when the water heater has not operated for some time (which is most often first thing in the morning), the initial flow of hot water may be reduced for a period of 5-10 seconds while the heat exchanger warms up. **This is both an energy and water saving feature of this water heater.** Once the heat exchanger has warmed up the hot water flow will increase and remain at normal flow levels. This feature will only occur at a cold start-up and not when the heat exchanger is already warm from a recent use of hot water.

WATER FLOW FLUCTUATES

Too many taps in use at the same time may cause a decrease in the hot water flow from the taps. This can also be evident if the water heater has been installed as an in-series gas booster to a solar water heater and the solar heated water is at a low temperature.

- Are there several hot taps open, or are appliances such as a dishwasher or washing machine, in use at the same time?

Ensure no more than two or three taps or appliances are on at the one time.

- Check the flow of hot water from each tap to see if one or more outlets are using more water than you think.

Have a plumber install a flow control valve to each shower outlet, basin and sink to reduce water usage.

GAS BOOSTER OPERATING TOO FREQUENTLY

If the water heater is installed as an in-series gas booster to a solar water heater, you may find that the water heater operates more frequently than expected. This will occur when the solar heated water temperature is lower than 58°C, which may be experienced during periods of low solar energy gain or if there has been heavy hot water usage. Factors to consider are:

- **Hot tap not used recently**

If a hot tap has not been used for a while, the water in the pipe work between the solar storage tank and the in-series gas booster may have cooled down. The in-series gas booster will sense the cooler water and this will cause the burners on the water heater to ignite and boost the water temperature when a hot tap is first turned on. The burners will extinguish when solar heated water of 58°C or higher from the solar storage tank reaches the in-series gas booster (refer also to “[Fan Continues to Run after Water Heater Operation Stops](#)” on page 18).

- **Insufficient sunlight**

Insufficient sunlight due to cloudy weather during hotter months or low solar energy contribution in colder months may mean the in-series gas booster operates more often.

- **Collectors shaded**

If trees or other objects shade the solar collectors or if the glass is dirty, the effectiveness of the solar collectors will be greatly reduced. Have the trees trimmed or the solar collectors relocated if the obstruction is permanent or clean the collector glass.

Ensure the glass on your solar collectors is free of dust, salt spray or any other matter, which may reduce the effectiveness of the solar collectors. If the collector glass becomes dirty, hose down or if the solar collectors are accessible, wash the collector glass with water and a soft brush when the solar collectors are cool.

- **Collector area is too small**

For most installations, the number of solar collectors recommended in Rheem literature has been proven to provide the required solar energy to meet the average family needs. However, in some circumstances, it may be necessary to install an additional solar collector.

- **Are you using more hot water than you think?**

Is one outlet (especially the shower) using more hot water than you think?

Very often it is not realised the amount of hot water used, particularly when showering. Carefully review the family’s hot water usage. As you have installed an energy saving appliance, energy saving should also be practised in the home. Adjust your water usage pattern to take advantage of maximum solar gains.

Have a plumber install a flow control valve to each shower outlet, basin and sink to reduce water usage.

- **Water heater size**

Do you have the correct size water heater for your requirements?

The sizing guide in the sales literature and on the Rheem website (www.rheem.com.au) suggests average sizes that may be needed.

FAN CONTINUES TO RUN AFTER WATER HEATER OPERATION STOPS

It is the normal operation of the water heater for the fan to continue running after heating of the water is finished. The fan may run for up to six minutes after the burners extinguish, to prepare for the next ignition.

CLOUDS OF WHITE 'VAPOUR' FROM THE FLUE TERMINAL

During the heating cycle, it is not unusual to see water vapour clouds steaming from the flue terminal, particularly on cold days. This is normal operation of the water heater.

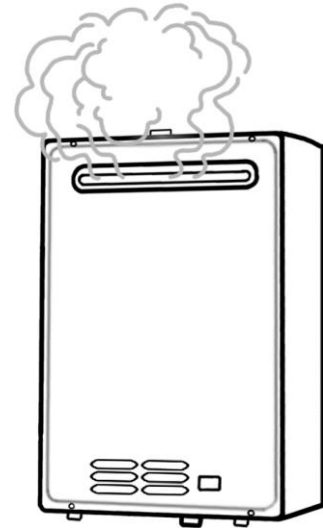

PRESSURE RELIEF VALVE DISCHARGING

A pressure relief valve is incorporated into the water heater controls. This valve protects the water heater, by allowing water to escape, in the event of excessive pressure build-up in the waterways.

- **Normal operation**

A small volume of water may discharge from the bottom of the water heater when a hot tap is suddenly closed.

- **Continuous dribble**

A continuous dribble may indicate the water supply pressure is above the design pressure for the water heater. If so, a pressure limiting valve must be installed on the cold water supply pipe to the water heater (refer to "[Mains Water Supply](#)" on page 22).

ERROR CODE

The water heater provides a diagnostic error code in the event of an interruption to its operation. The error code is displayed on the controller(s) (if installed) and on the LED display on the front of the water heater as a numerical value. If an error code appears:

- Close the hot tap, turn off the controller(s) and switch off the electrical supply to the water heater.
- Check the gas isolation valve at the gas inlet to the water heater is fully open.
- Wait 5 minutes, then switch on the electrical supply to the water heater, turn on a controller and open a hot tap.

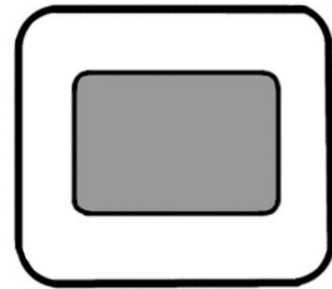

If the error code persists, take note of the numerical code, turn off the hot tap and turn off the controller(s). Phone Rheem Service or their nearest Accredited Service Agent to arrange for inspection.

HIGHER THAN EXPECTED GAS BILLS

Should you at any time, feel your gas bill is higher than expected, we suggest you check the following points:

- Is one outlet (especially the shower) using more hot water than you think?

Carefully review the family's hot water usage. Inexpensive flow control valves can be easily fitted to the shower outlets to reduce water usage.

- Is the in-series gas booster operating too frequently?

Refer to "[Gas Booster Operating Too Frequently](#)" on page 18.

- Has there been an increase in hot water usage?

An increase in hot water usage will result in an increase in water heater operation.

- Has your water heating tariff rate been increased by your gas retailer since your previous bill?



IF YOU HAVE CHECKED ALL THE FOREGOING AND STILL BELIEVE YOU NEED ASSISTANCE, PHONE RHEEM SERVICE OR THEIR NEAREST ACCREDITED SERVICE AGENT.

INSTALLATION – WATER HEATER

**THIS WATER HEATER IS FOR OUTDOOR INSTALLATION ONLY.
THIS WATER HEATER IS NOT SUITABLE FOR POOL HEATING.
Check the water heater is suitable for the gas type available.
(refer to the rating label on the water heater)**

INSTALLATION STANDARDS

The water heater must be installed:

- by a qualified person, and
- in accordance with the installation instructions, and
- in compliance with the Plumbing Code of Australia (PCA), Standards AS/NZS 3500.4 and AS/NZS 5601.1, and all local codes and regulatory authority requirements,
 - The Gas installations Standard AS/NZS 5601.1 places limitations on the location of a gas water heater within a covered area. Refer to [“Installation within a Covered Area”](#) on page 22.

874 series

⚠ Warning: This water heater may deliver water at high temperature. Refer to the Plumbing Code of Australia, local requirements and these installation instructions to determine if additional delivery temperature control is required. Refer to [“Hot Water Delivery”](#) on page 23.

876 series

This water heater delivers water not exceeding 50°C in accordance with AS 3498.

⚠ Warning: This water heater must only be installed in accordance with the acceptable plumbing configurations specified in these installation instructions. Failure to do so may result in conditions where delivery temperature control is inadequate. Refer to [“Water Temperature Diagrams”](#) on page 28.

All packaging materials must be removed from the water heater prior to its installation.

WATER HEATER APPLICATION

This water heater is designed for use in a single family domestic dwelling for the purpose of heating potable water. Its use in an application other than this may shorten its life.

If this water heater is to be used where an uninterrupted hot water supply is necessary for the application or business, then there should be back-up redundancy within the hot water system design. This should ensure the continuity of hot water supply in the event that this water heater was to become inoperable for any reason. We recommend you provide advice to the system owner about their needs and building back-up redundancy into the hot water supply system.

The 874 series of water heater may be installed as an in-series gas booster to a solar water heater. For information relating to the function and operation of the solar water heater, refer to the Owner’s Guide and Installation Instructions supplied with the solar water heater.

Note: Australian Standard AS 3498 requires that a water heater provides the means to inhibit the growth of Legionella bacteria in potable water. When the 874 series water heater is used as an in-series booster for a solar water heater it can satisfy the AS 3498 requirements provided it is energised, the booster preset outlet temperature setting is at least 70°C, and that a remote temperature controller is not used.

Note: The 876 series of water heater is marked “THIS APPLIANCE DELIVERS WATER NOT EXCEEDING 50°C IN ACCORDANCE WITH AS 3498” on the front panel. This model;

- **must not** be installed as an in-series gas booster to a solar water heater, as water temperature greater than 50°C can be delivered from the water heater contravening its compliance to AS 3498.

WATER HEATER LOCATION

The water heater is suitable for outdoor installation only and should be installed close to the most frequently used outlet and its position chosen with safety and service in mind. If this water heater is part of a solar water heater system, it should also be installed close to the solar storage tank. Make sure people (particularly children) will not touch the flue terminal. The flue terminal and air inlet must be clear of obstructions and shrubbery.

Clearance must be allowed for servicing of the water heater. The water heater must be accessible without the use of a ladder or scaffold. Make sure the entire front panel can be removed for service. You must be able to read the information on the rating plate. Remember you may have to take the entire water heater out later for servicing.

This water heater must be installed vertically upright with the water, gas and power connections on the underside, pointing toward the ground. The back of the water heater can be either against a wall or supported by a frame. A heat shield or insulating material or an air gap is not required between the back of the water heater and the wall or frame to comply with the temperature limitation requirement of AS/NZS 5601.1.



Note: The water heater must be well secured to the wall or frame using two fasteners each at the top and bottom of the unit (refer to page 29 for [mounting hole positions](#) and weight of the water heater). Use the screws provided only if they are suitable for the wall or frame type. Otherwise select and use alternative fasteners suitable for the application. The fasteners must be capable of bearing the full weight of the water heater so it may not work loose nor impose any load on the gas and water pipe work connected to the water heater. Refer to the fastener manufacturer’s information and recommendations for the type of fastener to use for the wall or frame type and load bearing requirements.

Alternatively the water heater can be recessed into a wall (refer to [“Recess Installation”](#) on page 22).

For a single water heater installation, refer to the [typical installation diagram](#) on page 30.

For a dual water heater installation using the EZ Link system, refer to [“EZ Link System Dual Installation”](#) on page 35 and the [typical installation diagram](#) on page 39.

The water heater must not be installed in an area with a corrosive atmosphere where chemicals are stored or where aerosol propellants are released. Remember the air may be safe to breathe, but when it goes through a flame, chemical changes take place which may attack the water heater.

A secondary flue is not required. The water heater must not be installed indoors or in a confined space.

The water heater must be located to ensure that the location of the flue terminal complies with the requirements of AS/NZS 5601.1. As a guide the following requirements are extracted from the Gas Installations Standard. The distances are measured along the wall behind the water heater.

- At least 300 mm between the top of the flue terminal and the eaves.
- At least 500 mm between the flue terminal and the edge of any opening into the building, such as an openable door or window, measured horizontally*.
- At least 1500 mm between the top of the flue terminal and the edge of any opening into the building, such as an openable window, measured vertically.
- At least 300 mm between the flue terminal and a return wall or external corner, measured horizontally*.
- At least 1500 mm between the flue terminal and any opening into a building, in the direction of the flue discharge.
- At least 500 mm between the flue terminal and a fence, wall or other obstruction, in the direction of the flue discharge.
- More than 450 mm between the flue terminal and a property boundary unobstructed by a fence, wall or other obstruction, in the direction of the flue discharge.

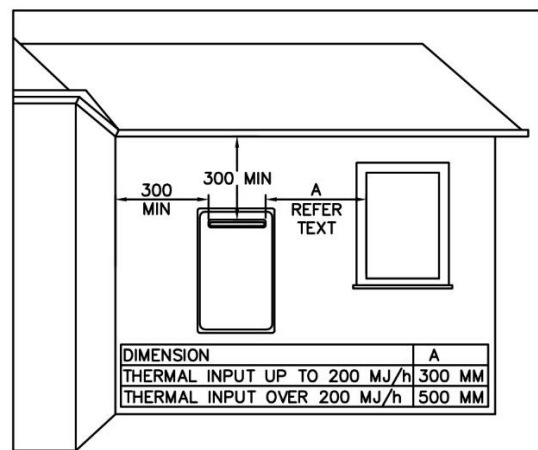

Note: * If these horizontal distances cannot be achieved, AS/NZS 5601.1 states an equivalent horizontal distance measured diagonally from the nearest discharge point of the flue terminal to the opening may be deemed to comply. Check with the local regulator.

INSTALLATION WITHIN A COVERED AREA

The water heater must be located such that the installation meets the requirements of AS/NZS 5601.1. There must be sufficient ventilation, so the water heater has an adequate supply of combustion air, and the flue products are readily dispersed safely and avoid being a nuisance. It is the licensed installer’s responsibility to ensure the installation complies with the relevant sections of the Gas installations Standard.

Installation of this water heater is permitted within a partially or fully covered area or recess that is not a balcony and is open on at least two sides, if its flue terminal is located to ensure a free flow of air across it is achieved.

Additional clearances to openings into the building or obstructions also apply, refer to AS/NZS 5601.1:2022 Figure and Table 6.9.3.

RECESS INSTALLATION

The water heater can be installed recessed into a wall. A recess box (Rheem Part Number 140341 or for WA PN 140331) is available for such an installation. Refer to the installation instructions which accompany the recess box kit for information on its installation.

The rating plate on the side of the water heater should be moved to or the information on it, including the water heater serial number, manufacture date and model number, indelibly copied onto either the front panel of the water heater or to another position which is visible when the water heater is installed so the householder or responsible officer can access the water heater details when required. An additional rating label is supplied attached to the inside of the front cover of the water heater. This is for a service person to access the water heater details when required.

MAINS WATER SUPPLY

Where the mains water supply pressure exceeds that shown in the table below, an approved pressure limiting valve that does not have non-return valve characteristics (such as an RMC PSL series valve) is required and should be fitted as shown in the [water and gas connection detail diagram](#) on page 31.

Model	B28
Relief valve setting	1750 kPa
Maximum mains supply pressure	1000 kPa
Minimum mains supply pressure *	120 kPa

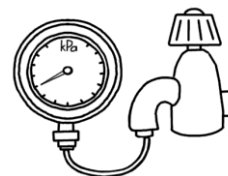

* minimum water supply pressure required to achieve the rated flow and performance

Notes

- It is not recommended to install this water heater with a low pressure water supply.
- A minimum water supply pressure of 120 kPa is required to achieve the rated flow and performance of the water heater.
- If this water heater is installed as an in-series gas booster for a solar water heater, the maximum water supply pressure to the solar water heater, without an expansion control valve (ECV), is generally 800 kPa, however it may be less than this for some models. Refer to the Owner’s Guide and Installation Instructions supplied with the solar water heater for maximum mains supply pressure details.
- If sludge or foreign matter is present in the water supply, it is recommended a suitable filter be incorporated in the cold water line to the water heater.
- This water heater is not suitable for connection to bore water or spring water unless a water treatment device is fitted.
- Refer to “[Water Supplies](#)” on page 16 for further information on water chemistry.

HOT WATER DELIVERY

⚠ Warning: This water heater can deliver water at temperatures which can cause scalding.

876 series – 50°C Limited Outlet

An 876 series water heater delivers water not exceeding 50°C in accordance with AS 3498. The risk of scald injury will be reduced.

There is no need to fit a temperature limiting device to satisfy the requirements of the Plumbing Code of Australia, if an 876 series water heater is installed and serving an application where 50°C is the maximum permissible hot water temperature at the outlet of a fixture or appliance used primarily for personal hygiene, such as in a bathroom or ensuite.

874 series – Hot Water Outlet

Depending upon its preset outlet temperature setting, an 874 series water heater can deliver hot water at a temperature up to 75°C when no temperature controller is installed and 60°C when a temperature controller is installed. These temperatures are sufficiently hot to cause severe scalding. A model used as a booster to a solar water heater can deliver hot water exceeding these temperatures. Water at these temperatures may be plumbed to fixtures where water hotter than 50°C is allowed, such as the kitchen and laundry.

The installing plumber may have a legal obligation to ensure the installation of this water heater meets the water temperature delivery requirements of the Plumbing Code of Australia so that heated water delivered to fixtures and appliances used primarily for personal hygiene is at a temperature which is unlikely to scald.

It is necessary and we recommend that a temperature limiting device be fitted between an 874 series water heater and the fixtures and appliances used primarily for personal hygiene such as in a bathroom, ensuite, public amenities or other ablution areas, to reduce the risk of scalding. The temperature limiting device must be of a type suitable for use with a gas continuous flow water heater. Refer to the manufacturer’s specifications of the temperature limiting device.

Where a temperature limiting device is installed adjacent to the water heater, the cold water line to the temperature limiting device can be branched off the cold water line either before or after the isolation valve and pressure limiting valve to the water heater.

If a pressure limiting valve is installed on the cold water line to the water heater and the cold water line to a temperature limiting device branches off before this valve or from another cold water line in the premises, then a pressure limiting valve of an equal pressure setting may be required prior to the temperature limiting device.

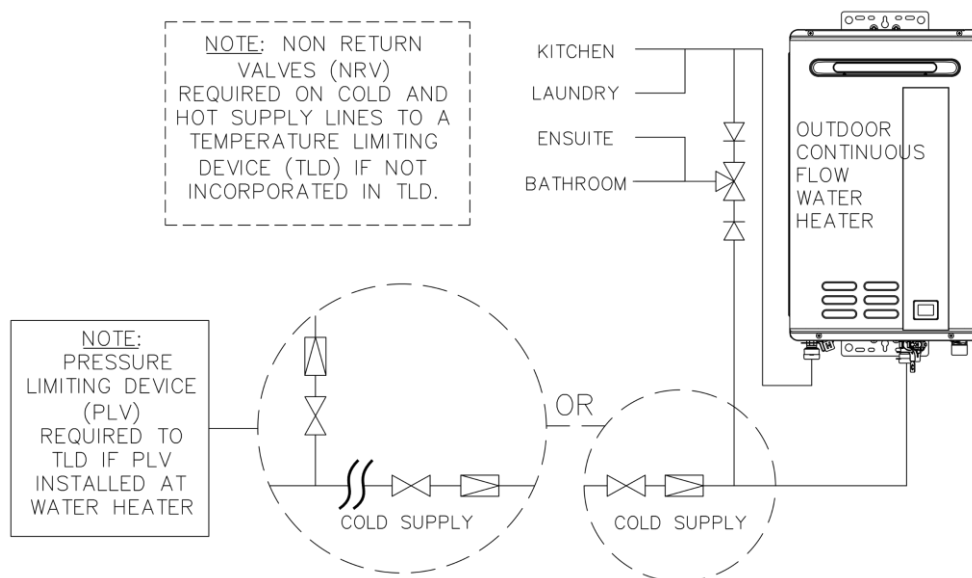

Two Temperature Zones Using a Temperature Limiting Device

Gas Booster for a Solar Water Heater

The temperature limiting device used with an 874 series in-series gas booster as part of a solar water heater installation must be of a type suitable for use with both a continuous flow water heater and a solar water heater. Refer to the manufacturer’s specifications of the temperature limiting device.

⚠ Warning: Temperature controllers **must not** be fitted to this water heater (874 series) if it is installed as an in-series gas booster with a solar water heater system because water at a temperature much higher than the controller setting can be delivered. If a solar water heater is installed to an existing water heater installation, then all controllers **must be** disconnected and removed.

Where a temperature limiting device is installed adjacent to the in-series gas booster, the cold water line to the temperature limiting device can be branched off from either the cold water line to the solar storage tank or another cold water line in the premises. It must not be branched off the water line from the solar storage tank.

If a pressure limiting valve is installed on the cold water line to the solar water heater and the cold water line to a temperature limiting device branches off before this valve or from another cold water line in the premises, then a pressure limiting valve of an equal pressure setting may be required prior to the temperature limiting device.

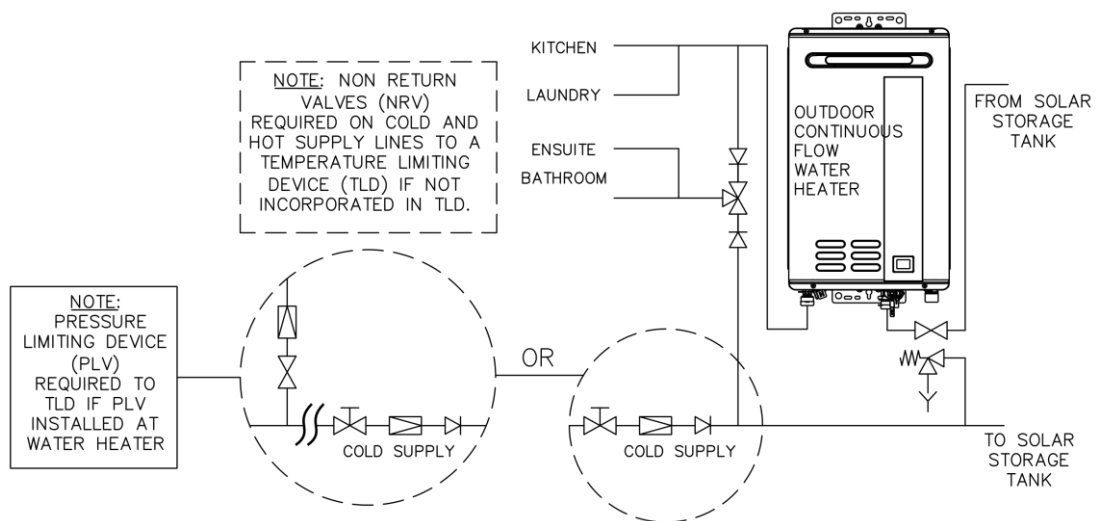

**In-series Gas Booster as part of a Typical Solar Water Heater Installation
Two Temperature Zones Using a Temperature Limiting Device**

Note: Refer to the installation instructions supplied with the solar storage tank for further information on the location of a cold water branch line to a temperature limiting device relative to the installation of the cold water valves in the cold supply pipework prior to the solar storage tank.

CIRCULATED HOT WATER FLOW AND RETURN SYSTEM

A Rheem 874B28 model continuous flow water heater can be installed as part of a circulated hot water flow and return system in a building.

Notes

- the preset outlet temperature setting of the water heater must be set to at least 60°C.
- the return water temperature to the water heater must not be less than 55°C.

If the water temperature decreases by more than 5°C due to heat loss from the ring main, the preset outlet temperature setting of the water heater must be set to above 60°C to ensure the return water temperature is not less than 55°C.

- temperature controllers should not be installed with this water heater as part of a circulated hot water flow and return system, including when installed as part of an EZ Link System dual installation.

The circulator must be:

- sized and set to provide a minimum flow rate of 3.0 L/min through the recirculated hot water flow and return system, and
- either thermostatically and / or timer controlled.

The circulator **must not** be set to operate continuously, i.e. 24 hours per day.

⚠ Warning: A Rheem 876 series continuous flow water heater **must not** be installed as part of a circulated hot water flow and return system in a building.

Temperature Limiting Device

A temperature limiting device cannot be installed in circulated hot water flow and return pipe work. The tempered water from a temperature limiting device cannot be circulated. Where a circulated hot water flow and return system is required in a building, a temperature limiting device can only be installed on a dead leg, branching off the circulated hot water flow and return pipe.

If circulated tempered water were to be returned back to the water heater, depending on the location of the return line connection on the water supply line to the water heater, then either:

- water will be supplied to the cold water inlet of the temperature limiting device at a temperature exceeding the maximum recommended water supply temperature, or
- when the hot taps are closed no water will be supplied to the cold water inlet of the temperature limiting device whilst hot water will continue to be supplied to the hot water inlet of the temperature limiting device.

These conditions may result in either water at a temperature exceeding the requirements of AS/NZS 3500.4 being delivered to the hot water outlets in the ablution areas, or the device closing completely and not delivering water at all, or the device failing. Under either condition, the operation and performance of the device cannot be guaranteed.

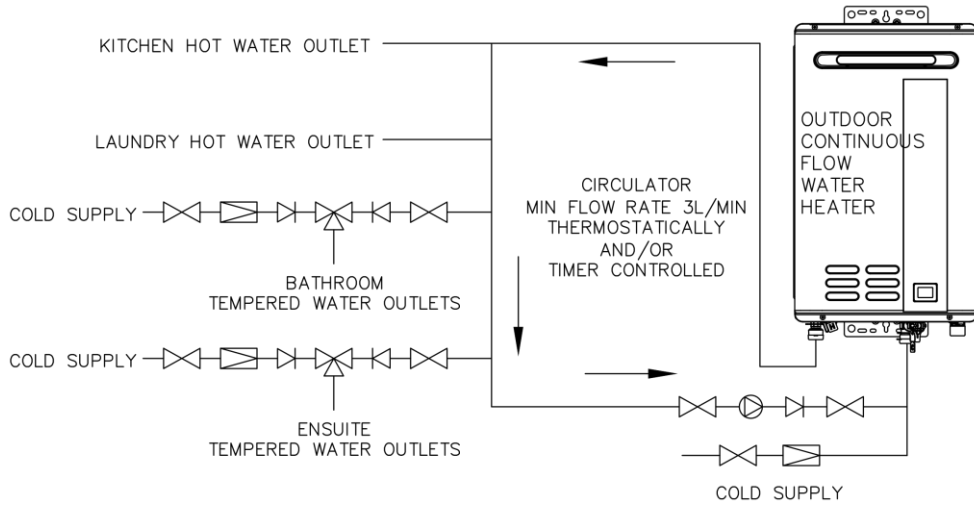

NOTE: A PLV IS REQUIRED TO BE INSTALLED ON THE COLD SUPPLY LINE TO THE TEMPERING VALVE IF A PLV IS INSTALLED ON THE COLD SUPPLY LINE TO THE WATER HEATER.
 NON RETURN VALVES (NRV) REQUIRED ON COLD AND HOT SUPPLY LINES TO A TEMPERATURE LIMITING DEVICE (TLD) IF NOT INCORPORATED INTO TLD.

Circulated Hot Water Flow and Return – Gas Continuous Flow Water Heater

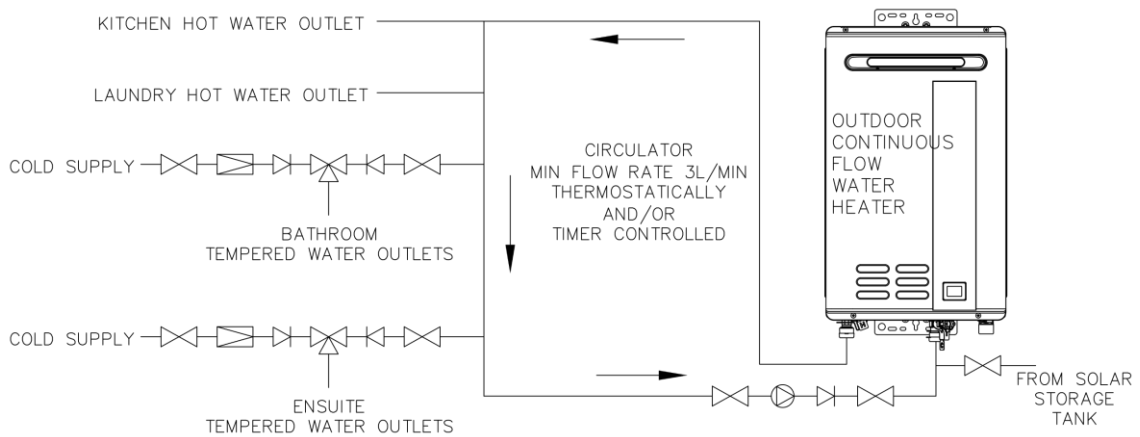

NOTE: A PLV IS REQUIRED TO BE INSTALLED ON THE COLD SUPPLY LINE TO THE TEMPERING VALVE IF A PLV IS INSTALLED ON THE COLD SUPPLY LINE TO THE WATER HEATER.
 NON RETURN VALVES (NRV) REQUIRED ON COLD AND HOT SUPPLY LINES TO A TEMPERATURE LIMITING DEVI (TLD) IF NOT INCORPORATED INTO TLD.

Circulated Hot Water Flow and Return – In-series Gas Booster as part of a Solar Water Heater Installation

FROST PROTECTION

The water heater has a frost protection system. The frost protection system will protect the water heater from damage, by preventing ice forming in the waterways of the water heater, in the event of freezing conditions occurring.

The frost protection system will be rendered inoperable if electrical power is not available at the water heater. Damage to the water heater caused by freezing of the pipe work to or from the water heater is not covered under the Rheem warranty. Refer to AS/NZS 3500.4 for precautions to be taken for installations in frost prone areas. The water heater is not suitable for installation in areas where the ambient temperature falls below - 20°C (including wind chill factor).

The cold water line to the water heater must be insulated with suitable thickness insulation if freezing conditions are likely to occur. The insulation must be fitted to the underside of the water heater and be weatherproof and UV resistant if exposed.

TEMPERATURE CONTROLLERS

The Rheem 874 and 876 series can be installed with Rheem Standard controllers to enable the user to control the temperature of the delivered water from the outlet of the water heater.

There are three types of Standard controller. They are the Kitchen controller, Bathroom 1 controller and the Bathroom 2 controller. The controllers are designed to be hard wired into the water heater using either the Kitchen controller cable or the Bathroom controller cable.

Temperature controllers are only suitable for either a single water heater installation or a dual water heater installation using the EZ Link system. They are not suitable if multiple water heaters are manifolded together. Other manufacturers' controllers are not suitable to and cannot be installed with this water heater.

⚠ Warning: Temperature controllers **must not** be fitted to this water heater (874 series) if it is installed as an in-series gas booster with a solar water heater system because water at a temperature much higher than the controller setting can be delivered. If a solar water heater is installed to an existing water heater installation, then all controllers **must be** disconnected and removed.

Refer to the Rheem website for the Owner's Guide and Installation Instructions for the Standard Rheem Controllers. Visit www.rheem.com.au/rheem/help#guides.

EZ LINK DUAL INSTALLATION

Two 874B28 or 876B28 gas continuous flow water heaters can be installed as an EZ Link dual installation. The EZ Link® system is designed to electronically control the two gas continuous flow water heaters and have them operate as one. One or both water heaters may be in operation, depending upon the hot water demand. The second water heater will only operate when the hot water demand exceeds the capacity of the first water heater to supply.

Refer to "EZ Link System Dual Installation" on page 35.

REDUCING HEAT LOSSES

The hot water line from the water heater and the pipe work between the solar storage tank, if one is installed, and the in-series gas booster must be insulated in accordance with the requirements of AS/NZS 3500.4. The insulation must be weatherproof and UV resistant if exposed. The insulation must be fitted up to the connections on the both the underside of the water heater and the solar storage tank.

WATER TEMPERATURE DIAGRAMS

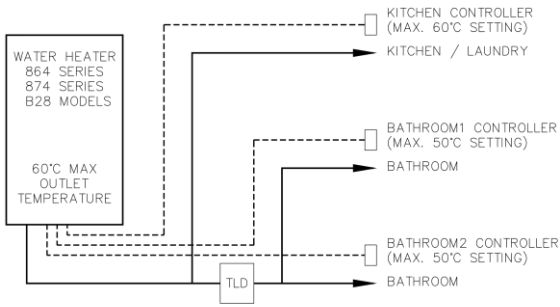

874 Series - Kitchen and Bathroom Controllers

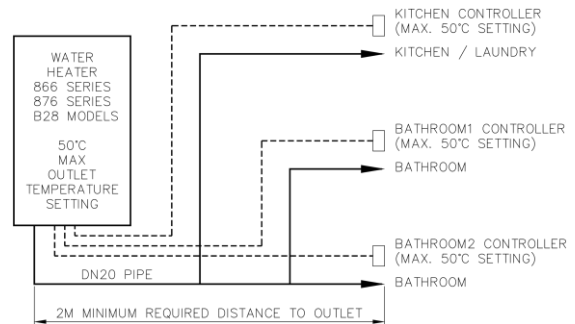

876 Series – Kitchen and Bathroom Controllers

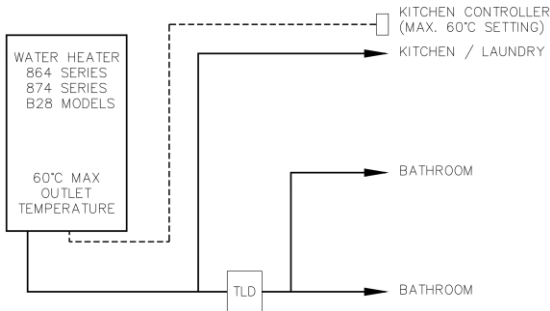

874 Series - Kitchen Controller Only

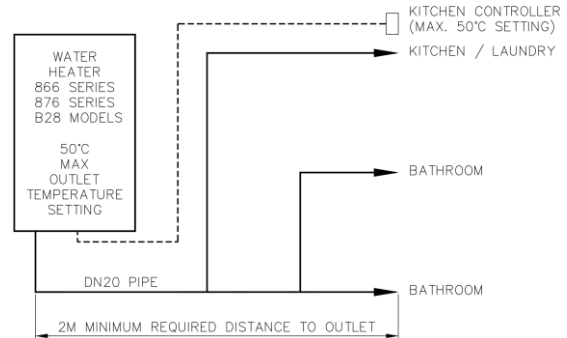

876 Series - Kitchen Controller Only

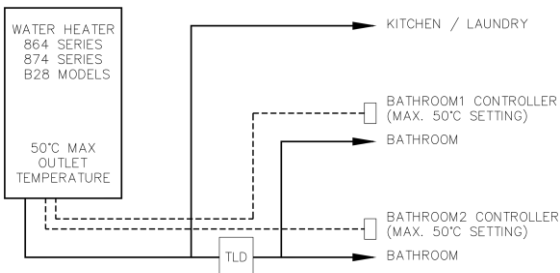

874 Series - Bathroom Controllers Only

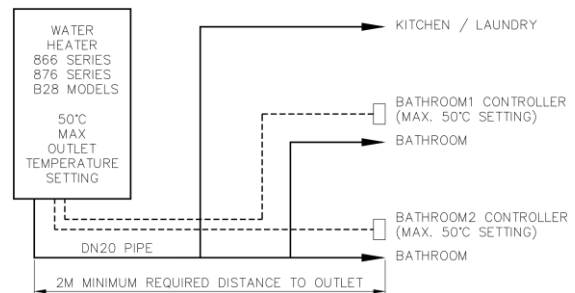

876 Series - Bathroom Controllers Only

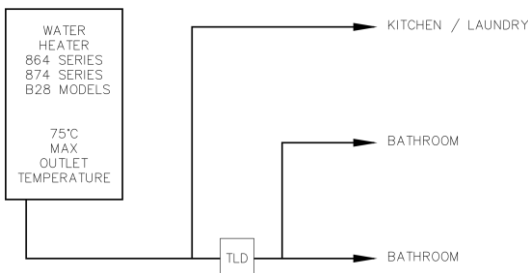

874 Series - No Controllers

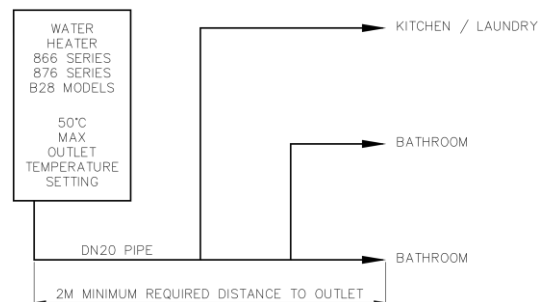

876 Series - No Controllers

Notes

- Temperature Limiting Devices – refer to “Hot Water Delivery” on page 23.
- Factory preset outlet temperature setting is:

- 874 series 60°C 876 series 50°C

DIMENSIONS AND TECHNICAL DATA

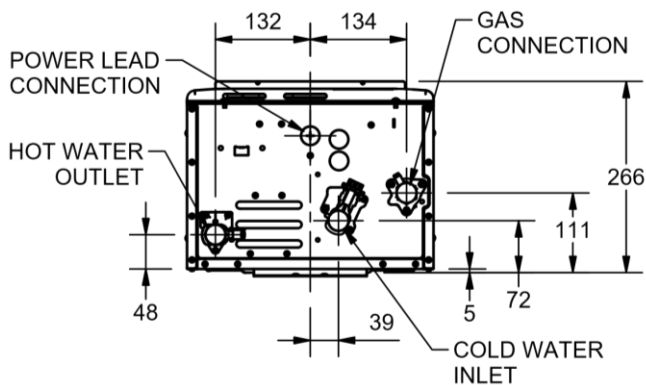
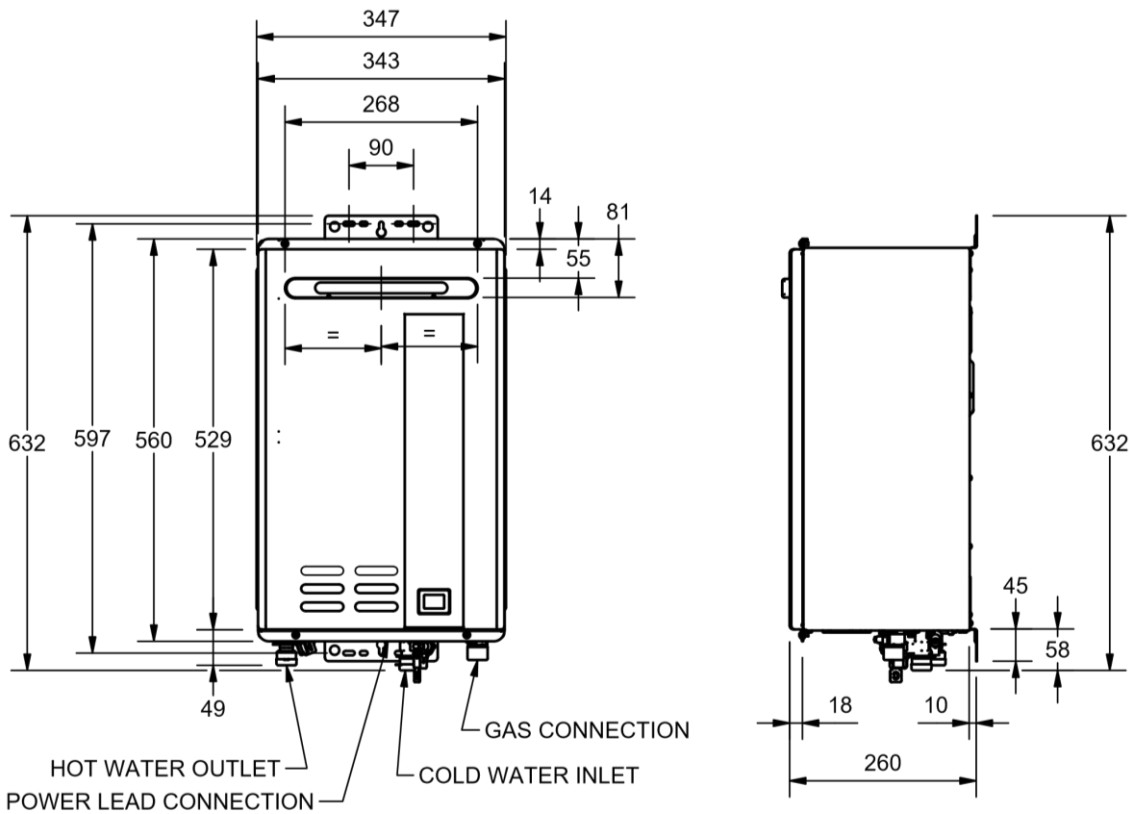

Model		874B28 876B28 Natural, Propane
Water heating capacity @ 40°C rise	litres / min	17.5
Nominal capacity @ 25°C rise	litres / min	28
Mass Empty (unpacked)	kg	27

Technical data is subject to change.

Gas Details	Hourly Gas Consumption (MJ)	Min Gas Pressure (kPa)	Test Point Gas Pressure (kPa)		Max Gas Pressure (kPa)	Injector Size (mm)
			minimum	maximum		
Model	874B28 876B28	874B28 876B28	874B28 876B28	874B28 876B28	874B28 876B28	874B28 876B28
Natural	210	1.13	0.200	0.760	3.50	19 x Ø 1.73 & 19 x Ø 1.25
Propane (AU)	210	2.75	0.310	0.990	3.50	19 x Ø 1.11 & 19 x Ø 0.80

Model Numbers

- Gas type Letter N or P is included in the model number to denote gas type.
N = Natural, P = Propane (AU).
E.g. 874B28NF, 876B28PF
- Frost protection Letter F is included in the model number to denote frost protection.

TYPICAL INSTALLATION – OUTDOOR LOCATION

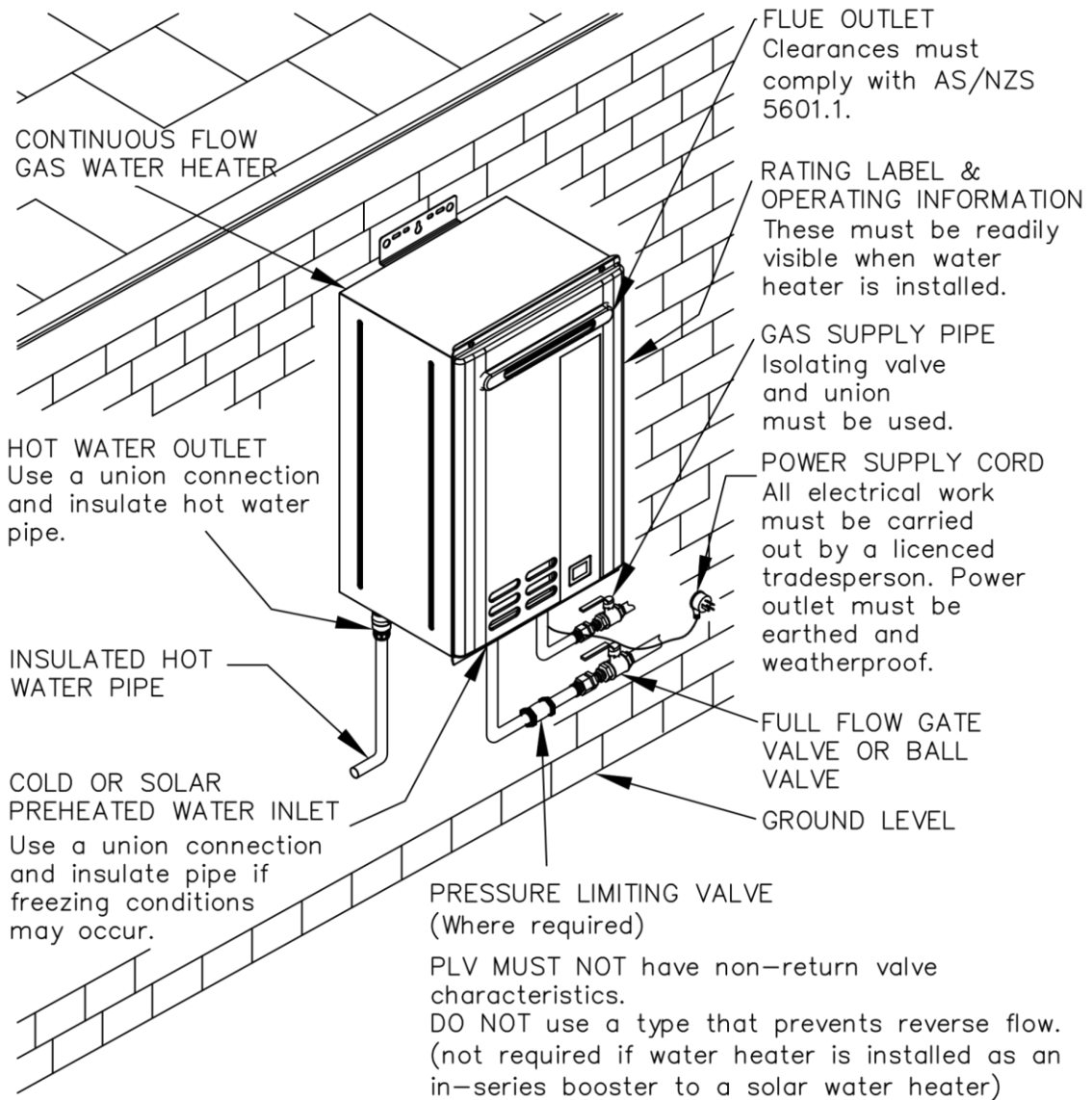

CONNECTIONS – PLUMBING

All plumbing work must be carried out by a qualified person and in compliance with the Standard AS/NZS 3500.4 and all local codes and regulatory authority requirements.

All gas work must be carried out by a qualified person and in compliance with the Standard AS/NZS 5601.1, all local codes and regulatory authority requirements.

CONNECTION SIZES

Model	874B28	876B28
Hot water outlet connection	R 3/4	-
50°C limited outlet connection	-	R 3/4
Cold water inlet connection	R 3/4	R 3/4
Gas inlet connection	R 3/4	R 3/4

WATER INLET AND OUTLET

All pipe work must be cleared of foreign matter before connection and purged before attempting to operate the water heater. All olive compression fittings must use brass or copper olives. Use an approved thread sealant such as Teflon tape on all threaded joints. Only use sufficient thread sealant to seal a joint. Refer to the sealant manufacturer's guidelines for how much and where to use.

⚠ Warning: Sealant must not be allowed in the waterways of pipe work or fittings. Excess sealant may be carried into the water heater where it will damage components and block the internal filters. This damage to components or blockage of filters is not covered by the Rheem warranty and a service rectification fee will be charged.

A full flow gate valve or ball valve must be installed on the cold water line to the water heater. **A non-return valve or stop tap must not be installed.** An acceptable arrangement is shown in the diagram. Refer also to "[Hot Water Delivery](#)" on page 23 and to "[Mains Water Supply](#)" on page 22.

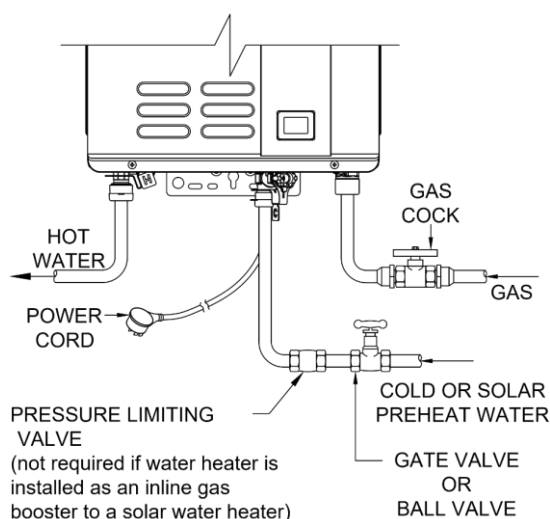

**Gas Water Heater
Cold (or Solar Preheat) and Hot Water
and Gas Connection Details**

A disconnection union must always be provided at the cold water inlet and hot water outlet on the water heater to allow for disconnection of the water heater.

Insulation used on the cold and hot water lines must extend up to the cold water inlet and hot water outlet of the water heater.

This water heater is intended to be permanently connected to the water mains and not connected by a hose-set. A braided flexible hose or semi-flexible connector may be used for connection to the water heater, where permitted by AS/NZS 3500.4.

Notes

- It is essential all pipe connections be correctly aligned, otherwise component connections within the water heater may be strained and / or components themselves misaligned. It is recommended also, wherever possible, pipe connections be made at the water heater first and final pipe runs be made in soft copper pipe to allow some adjustment for misalignment.
- Use the spanner flats on the water heater fittings and take care to avoid twisting the water inlet and outlet pipes inside the jacket.

PIPE SIZES

The pipe sizing for hot water supply systems should be carried out by persons competent to do so, choosing the most suitable pipe size to ensure adequate flow for each individual application. Reference to the technical specifications of the water heater and local regulatory authority requirements must be made.

To achieve true mains pressure operation, the cold water line to the water heater should be the same size or bigger than the hot water line from the water heater.

The minimum recommended cold pipe or solar preheat pipe and hot pipe size is DN20.

IN-SERIES BOOSTER

The pipe work between the solar storage tank (if one is installed) and the in-series gas booster has a minimum recommended pipe size of DN20 and **MUST BE** of copper unless an insulated braided flexible hose is provided with a solar water heater connections kit for this purpose.

The pipe work shall be fully insulated with a closed cell type insulation or equivalent in accordance with the requirements of AS/NZS 3500.4. The insulation must be weatherproof and UV resistant if exposed. The insulation must be fitted up to the connections on both the solar storage tank and the in-series gas booster.

A full flow isolation valve may be installed on the solar preheat water line from a solar storage tank to the in-series gas booster.

GAS INLET

The gas connection is made at the underside of the water heater. The pipe work must be cleared of foreign matter before connection and purged before attempting to operate the water heater. An isolation valve and disconnection union must be installed to allow servicing and removal of the water heater (refer to the [diagram on page 31](#)).

Note: Refer to the Gas Installations Standard AS/NZS 5601.1 for the correct method of sizing the gas supply pipe to the water heater. The pipe size selection must take into account the high gas input of this water heater ([refer to table on page 29](#)) as well as all of the other gas appliances in the premises.

⚠ Warning: Always isolate the water heater before pressure testing the gas supply system. Disconnect the water heater after the isolation valve to prevent the risk of serious damage to the gas control. The Rheem warranty does not cover damage of any nature resulting from failure to observe this precaution. Refer to rating label for gas types and pressures.

CONNECTIONS – ELECTRICAL

All electrical work and permanent wiring must be carried out by a qualified person and in accordance with the Wiring Rules AS/NZS 3000 and all local codes and regulatory authority requirements.

⚠ Warning: Temperature controllers **must not** be fitted to this water heater (874 series) if it is installed as an in-series gas booster with a solar water heater system because water at a temperature much higher than the controller setting can be delivered. If a solar water heater is installed to an existing water heater installation, then all controllers **must be** disconnected and removed.

The water heater is supplied with a 1.8 metre lead and plug and requires a weatherproof 220 - 240 V a.c. 50 Hz general purpose outlet (GPO) to be located within 1.2 metres of the installation. The GPO must be clear of the flue exhaust, draining water, gas supply pipe and water connections.

The power consumption of the water heater is:

Models	Power consumption	Comments
874B28 and 876B28 models natural gas and propane gas @ 220 V – 240 V a.c. 50 Hz	< 1 Watt	Burner off, anti-frost device inactive
	95 Watts	Burner off, anti-frost device active
	67 Watts	Burner on, anti-frost device inactive

The water heater will only operate on a sine wave at 50 Hz. Devices generating a square wave cannot be used to supply power to the water heater.

WIRING DIAGRAM

WIRING DIAGRAM

COLOR CODE

R	: RED
W	: WHITE
BR	: BROWN
BK	: BLACK
BL	: BLUE
GY	: GRAY
G	: GREEN
O	: ORANGE
Y	: YELLOW
Y/G	: YELLOW/GREEN

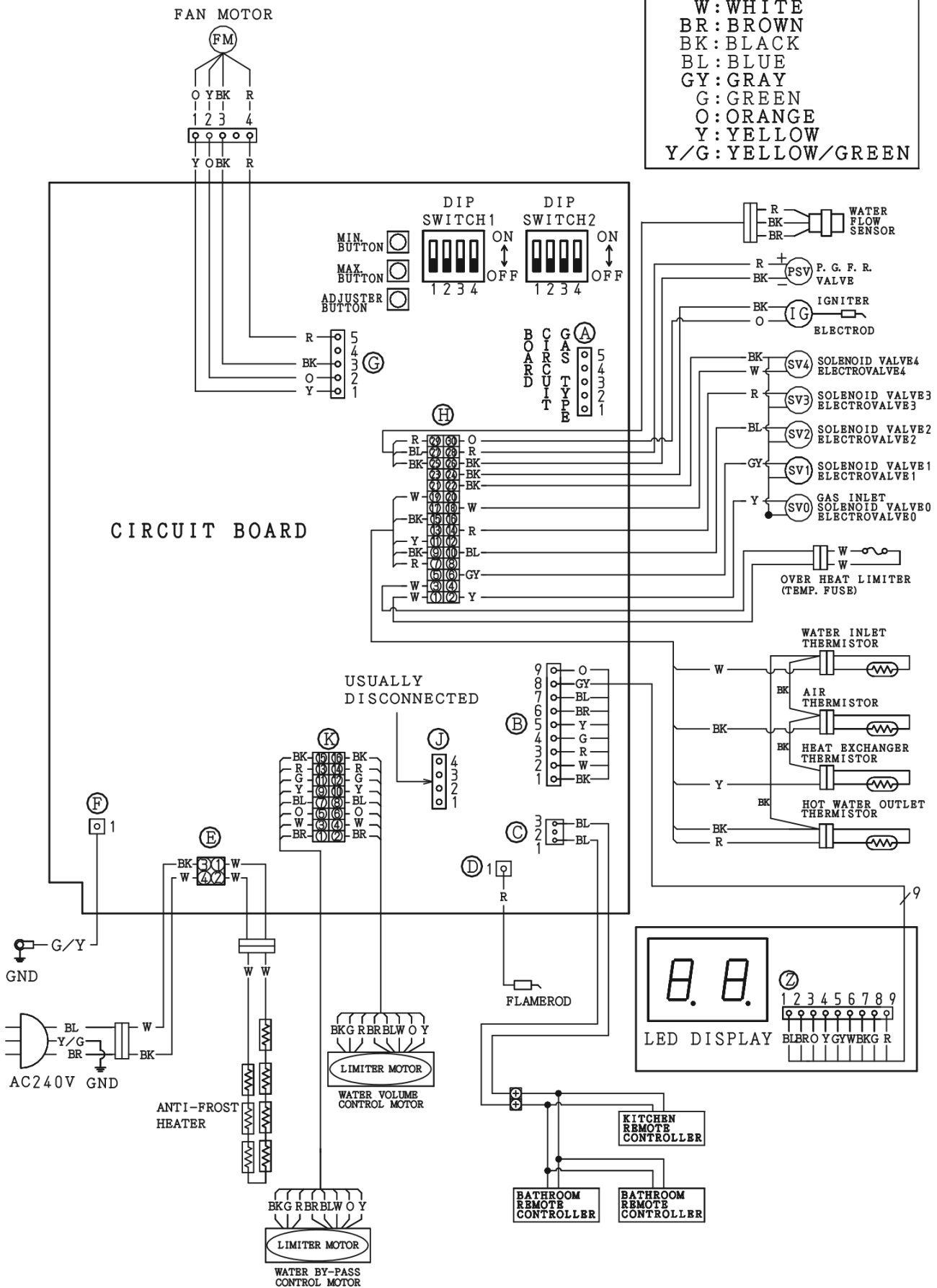

Wiring Diagram – 874, 876 Series B28 Models

EZ LINK SYSTEM DUAL INSTALLATION

The EZ Link® system is designed to electronically control two gas continuous flow water heaters and have them operate as one. One or both water heaters may be in operation, depending upon the hot water demand. The second water heater will only operate when the hot water demand exceeds the capacity of the first water heater to supply.

The EZ Link system is suitable for installation with Rheem 874 and 876 series B28 model gas continuous flow water heaters. The EZ Link Kit PN 299291 is required for the installation.

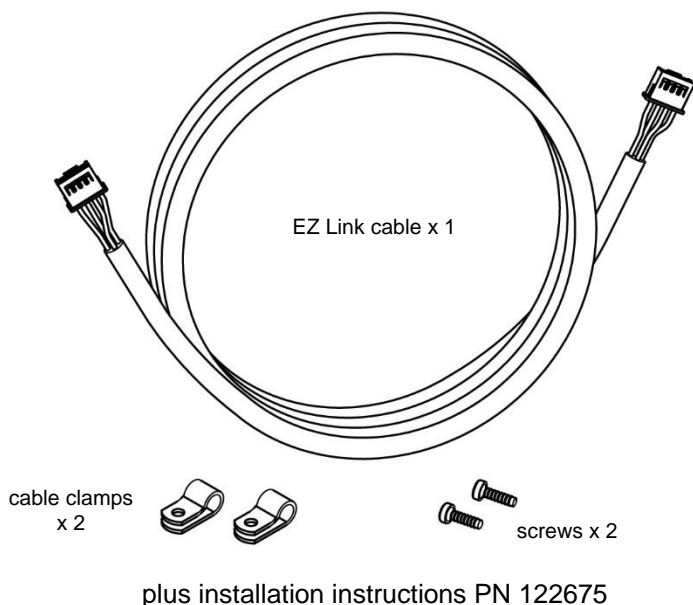

EZ Link Kit – PN 299291

Notes

- Only two gas continuous flow water heaters can be installed with an EZ Link system.
- The EZ Link system will vary the start-up sequence of the two water heaters.
- The two continuous flow water heaters must be of the same model. The performance of two different model water heaters manifolded together cannot be guaranteed.
- It is recommended the two water heaters be set with the same preset outlet temperature setting.
- A Rheem temperature controller(s) may be installed but is not required to be installed with the EZ Link system on a Rheem 874 and 876 series B28 model dual installation.
- If the EZ Link system is used with a water heater with a preset outlet temperature greater than 60°C and a temperature controller is installed, the maximum outlet temperature of the water heater will be limited by the maximum temperature setting of the temperature controller.
- Two Rheem 874B28 model water heaters manifolded together and with an EZ Link system installed can be used as an in-series gas booster system to a solar water heater installation so long as a temperature controller is not installed.

⚠ Warning: Temperature controllers **must not** be fitted to a water heater (874 series) if it is installed as an in-series gas booster with a solar water heater system because water at a temperature much higher than the controller setting can be delivered.

DUAL INSTALLATION

The two water heaters can be installed side by side with minimal clearance between them. Rheem 874 and 876 series B28 models are certified for installation with an exemption from the 300 mm minimum clearance requirements between flue terminals, as stated in AS/NZS 5601.1 clause 6.9.3.

Install two water heaters of the same model in a parallel plumbing arrangement. It is good practice, but not essential, to install the two water heaters in an Equa-Flow® manifold plumbing arrangement. There are basic installation requirements which must be followed:

1. The pipe work must be sized to meet the requirements of both AS/NZS 3500.4 and the application. It is recommended to use minimum DN25 pipe for the cold water line, cold and hot headers and hot water line and DN20 for the cold and hot water branch lines of each water heater.
2. A full flow gate valve or ball valve must be installed on the cold water line to the system. A non-return valve or stop tap must not be installed.
3. A full flow gate valve or ball valve (not a stop tap) should be installed on both the cold water branch and hot water branch of each water heater.
4. An isolation valve must be installed on the gas branch of each water heater.
5. Non-return valves or pressure limiting valves must not be installed on the branch lines to the water heaters.
6. All fittings, valves and branch lines should be matched sets to each of the water heaters.
7. Sufficient space must be left to enable access, servicing or removal of either water heater.

Refer to the '[Typical Two Unit Manifold with EZ Link Connection](#)' diagram on page 39 for installation and plant layout details.

RATING LABEL INFORMATION

There is information on the rating label located on the right hand side of the water heater, which may be required for future warranty and service requirements. This information will be hidden on the left hand water heater if the two water heaters are installed with minimal clearance between them.

Move the rating label to or indelibly copy the water heater serial number, manufacture date and model number from the label onto the left hand side or front panel of the left hand water heater or to another position which is visible when the water heater is installed so the householder or responsible officer can access the water heater details when required.

A second rating label is attached to the inside of the front cover. This is for a service person to access the water heater details when required.

TEMPERATURE CONTROLLER

A temperature controller(s) may be installed but is not required to be installed on the Rheem 874 and 876 series B28 model water heaters with the EZ Link system.

⚠ Warning: Temperature controllers **must not** be fitted to a water heater (874 series) if it is installed as an in-series gas booster with a solar water heater system because water at a temperature much higher than the controller setting can be delivered.

Connect a temperature controller to one only of the two water heaters. Up to three temperature controllers of the same family can be installed to this water heater. Refer to the Owner's Guide and Installation Instructions of the controllers for the procedure to connect the controller(s).

The water heater connected with the temperature controller(s) will become the 'master' water heater. The installed temperature controller(s) will control the temperature and functionality of both water heaters.

The maximum outlet temperature of the water heaters will be limited by the maximum temperature setting of the temperature controller.

A temperature controller should not be installed if two 874 series B28 model water heaters are installed with an EZ Link system and they are part of a circulated hot water flow and return system in a building. Refer to "[Circulated Hot Water Flow and Return System](#)" on page 25.

EZ LINK CABLE CONNECTION

The references in steps 6 to 9 are to the 'Control Board with EZ Link Connection' diagram on page 38. To connect the EZ Link cable to the water heaters:

1. Close any hot taps and ensure the burners on both water heaters are not operating.
2. Switch off the electrical supply at the power outlet to each water heater.
3. Remove the screws holding the front panel to the jacket on each water heater.
4. Gently disengage the front panel and pull forward to remove from each water heater.
5. Carefully remove the plastic protective cover from in front of the PCB board from each water heater. This is held in position with three holes in its top side and right side, engaging with three spigots in the PCB support housing.
6. Connect one end of the EZ Link cable to the first water heater.

If a controller(s) is connected to one of the water heaters, then this is the 'first' or 'master' water heater.

- Draw the cable through one of the spare cable grommets to the right of the power cord entry on the underside of the water heater.
- Plug the cable into the four pin connector located at the middle bottom of the Control Board (refer to the Control Board diagram on page 38).

The connector will only fit one way.

- Press until the connector snaps into place.
- Secure the EZ Link cable with the clamp and screw provided using the hole on the right hand side of the PCB support housing just below the two terminal connections (refer to the Control Board diagram).

7. Switch DIP SWITCH 4 to the on (up) position on the first water heater (refer to the Control Board diagram).

Note: This dip switch is on the DIP 1 set of dip switches.

- If a temperature controller is not installed, then also switch DIP SWITCH 1 of the DIP 2 set of dip switches to the on (up) position on the first water heater.

8. Connect the other end of the EZ Link cable to the second water heater.

- Draw the cable through one of the spare cable grommets to the right of the power cord entry on the underside of the water heater.

- Plug the cable into the four pin connector located at the middle bottom of the Control Board (refer to the Control Board diagram).

The connector will only fit one way.

- Press until the connector snaps into place.
- Secure the EZ Link cable with the clamp and screw provided using the hole on the right hand side of the PCB support housing just below the two terminal connections (refer to the Control Board diagram).

9. Switch DIP SWITCH 4 to the on (up) position on the second water heater (refer to the Control Board diagram).

Note: This dip switch is on the DIP 1 set of dip switches.

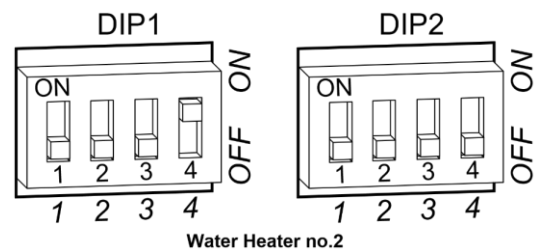
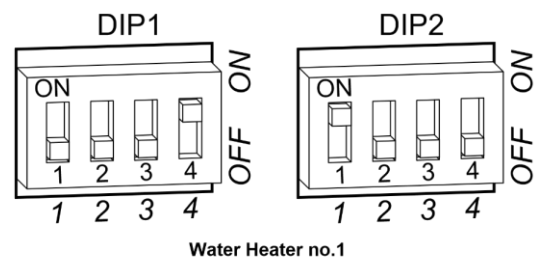

**dip switch settings
without temperature controller**

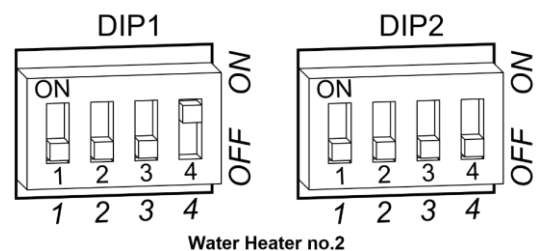
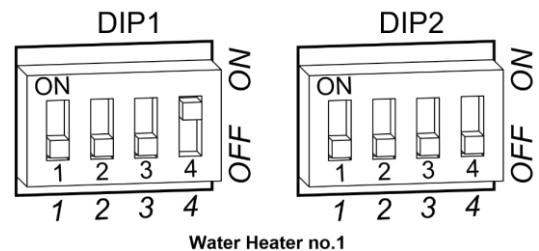

**dip switch settings
with temperature controller connected**

10. Carefully replace the plastic protective cover over the front of the PCB board to each water heater. Secure in position by engaging the three spigots in the PCB support housing through the three holes in the protective cover's top side and right side.
11. Refit the front panel and screws to each water heater.
12. Check the main gas isolation valve and the isolation valves at the gas inlet to each water heater are fully open.
13. Switch on the electrical supply at the power outlets to the water heaters.
14. Turn on the controller by pressing the on / off (⏻) button, if one is installed.
The on / off operating light and the priority light will both glow.
15. Check to ensure the flow from each connected hot tap is sufficient to operate a water heater.
 - Open each hot tap independently.
One of the water heaters will operate automatically.

Note: The minimum operating flow rate for each water heater is 1.5 litres per minute.
16. Increase the hot water flow by turning on multiple hot taps until both of the water heaters operate to ensure the EZ Link system is working correctly.
17. Turn off the hot taps.

Refer to “Commissioning” on page 40 for details on completing the installation.

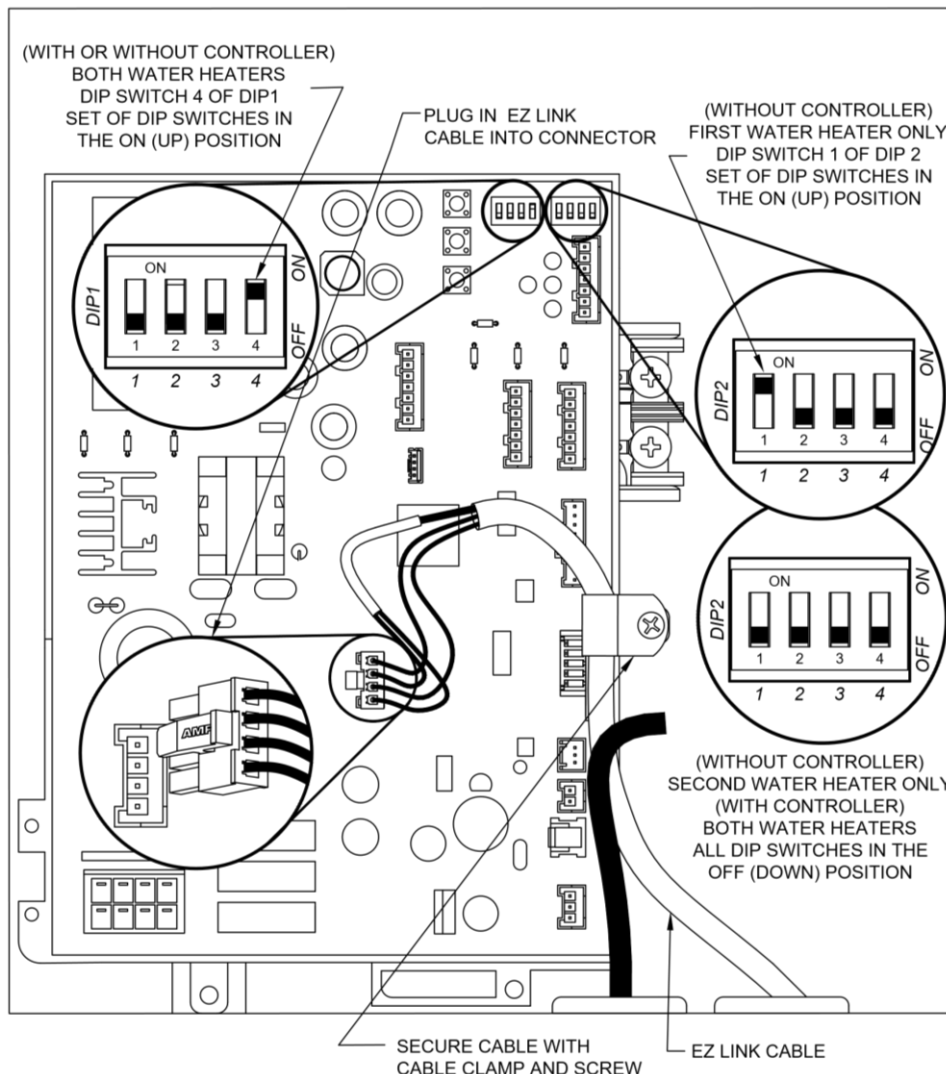

Control Board with EZ Link Connection

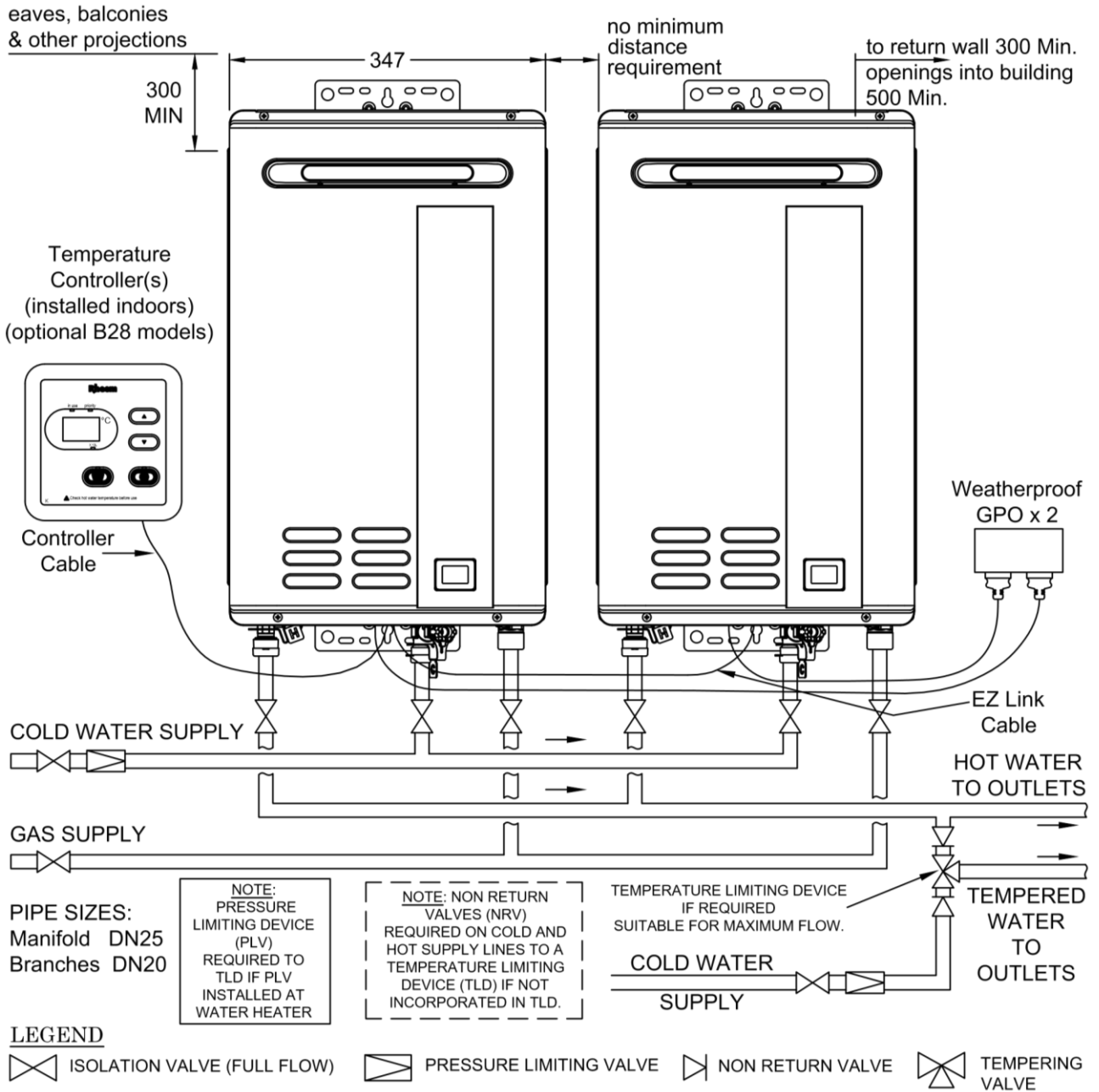

Typical Two Unit Manifold with EZ Link Connection

COMMISSIONING

All water heaters are tested and adjusted before dispatch from the factory, however further adjustments may become necessary because of local conditions.

TO TURN ON THE WATER HEATER

- Open all of the hot taps in the house (don't forget the shower).
- Open the cold water isolation valve fully at the inlet to the water heater.
Air will be forced out of the taps.
- Close each tap as water flows freely from it.
- Check the pipe work for leaks.
- Open the gas isolation valve fully.
- Check the gas pipe work for leaks.
- Plug in the water heater at the power outlet and switch on the electrical supply.
- Turn on a controller, if one is fitted, by pressing the on / off (⏻) button.
The on / off operating light and the priority light will both glow.
- Open a hot tap.
The water heater will operate automatically.
- Check to ensure the flow from each connected hot tap is sufficient to operate the water heater.
The minimum operating flow rate for all models is 1.5 litres per minute.
- Check and if required adjust the preset outlet temperature setting of the water heater.
Refer to "[Preset Outlet Temperature Setting](#)" on page 44.
- Check and if required adjust the outlet temperature compensation adjustment on an 876 series water heater.
Refer to "[Outlet Temperature Compensation Adjustment](#)" on page 46.

The automatic water governor incorporated in the water heater is not adjustable.

To complete the installation, it is necessary to check the gas supply pressure at the inlet to the water heater (refer to "[Gas Inlet Pressure](#)" on page 40), the minimum test point pressure and the maximum test point pressure (refer to "[Burner Gas Pressure](#)" on page 42).

Upon completion and testing of the installation, ensure the controller(s) is turned off (if fitted). Explain to the householder or a responsible officer the functions and operation of the water heater and the controllers (if fitted).

⚠ Warning: Upon completion of the installation and commissioning of the water heater, leave this guide with the householder or a responsible officer. **DO NOT** leave this guide inside of the cover of the water heater, as it may interfere with the safe operation of the water heater or ignite when the water heater is turned on.

GAS INLET PRESSURE

IMPORTANT - CHECK the gas supply pressure at the inlet to the water heater with the water heater and all other gas burning appliances in the premises operating (burners alight). The minimum gas supply pressure is:

Natural Gas	1.13 kPa	Propane Gas	2.75 kPa
-------------	----------	-------------	----------

If this minimum cannot be achieved, it may indicate the meter or the gas line to the water heater is undersized. It is important to ensure that an adequate gas supply pressure is available to the water heater when other gas burning appliances, on the same gas supply, are operating.

Gas Inlet Test Point Pressure

To check the gas inlet pressure:

1. Close any hot taps and ensure the burners are not operating.
2. Close the gas isolation valve at the gas inlet to the water heater.
3. Locate the gas inlet test point on the gas connection to the water heater.
 - Remove the test point screw and washer from the test point orifice.
 - Connect the manometer.
4. Open the gas isolation valve fully at the gas inlet to the water heater.

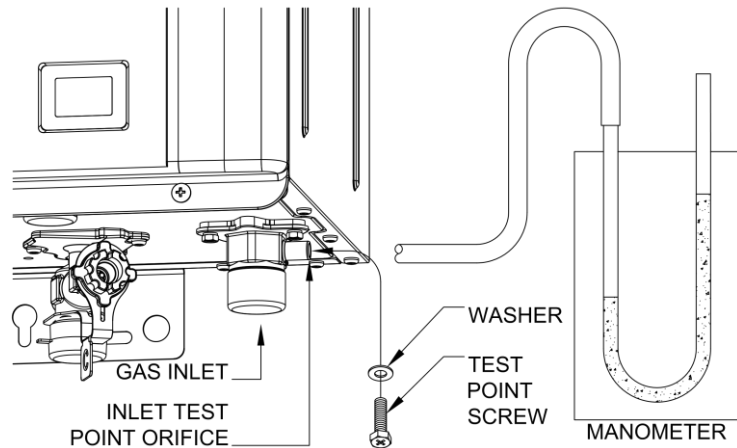

5. Observe the gas pressure reading on the manometer.

If the manometer reading is between the minimum and maximum inlet gas pressure ratings on the rating label, no adjustment is required.

If the manometer reading is below the minimum inlet gas pressure rating on the rating label, then either the gas pipe to the water heater is undersized and needs to be rectified or adjustment is required at the gas regulator.

If the manometer reading is above the maximum inlet gas pressure ratings on the rating label, then adjustment is required at the gas regulator.

6. Switch on the electrical supply at the power outlet to the water heater if it is not already switched on and turn on a controller, if one is fitted, by pressing the on / off (⏻) button.
7. Open a hot tap fully and ensure the burners are fully ignited.

It may be necessary to open a second tap.
8. Turn on all other gas burning appliances in the house which are on the same gas supply.
9. Observe the gas pressure reading on the manometer.

If the manometer reading is between the minimum and maximum inlet gas pressure ratings on the rating label, no adjustment is required.

If the manometer reading is below the minimum inlet gas pressure rating on the rating label, then either the gas pipe to the water heater is undersized and needs to be rectified or adjustment is required at the gas regulator.

If the manometer reading is above the maximum inlet gas pressure ratings on the rating label, then adjustment is required at the gas regulator.

10. Turn off the other gas burning appliances in the house.
11. If an adjustment was made during Step 9, repeat this procedure from Step 5.
12. Close the hot tap(s).
13. Close the gas isolation valve at the inlet to the water heater.
14. Remove the manometer and refit and tighten the test point screw and washer.
15. Open the gas isolation valve fully at the gas inlet to the water heater.
16. Open a hot tap again so the burners ignite.
17. Test for gas leaks.
18. Close the hot tap.

BURNER GAS PRESSURE

It is necessary to check the burner gas pressure at both the minimum and maximum operational settings. To check and if necessary adjust the operational gas pressures, the electrical supply to the water heater must be switched on, the burners ignited and hot water must be flowing from a hot tap.

Warning: The removal of the front panel will expose 220 - 240 V a.c. wiring. Take care not to touch wiring terminals.

Warning: This procedure will involve pressing the MIN, MAX and adjuster buttons. The pressing of these buttons should only be performed with an insulated tool.

Note: If an 874 series model is installed as an in-series gas booster for a solar water heater, then during this procedure the temperature of the water entering the in-series gas booster must be below 58°C. Otherwise the gas burners will not ignite and the operational gas pressures cannot be measured.

Minimum burner test point gas pressure

Refer to the rating label on the water heater for the minimum burner test point gas pressure.

1. Close any hot taps and ensure the burners are not operating.
2. Turn off the controller(s), if one is fitted, by pressing the on / off (⏻) button and switch off the electrical supply at the power outlet to the water heater.
3. Remove the screws holding the front panel to the jacket.
4. Gently disengage the front panel and pull forward to remove from the water heater.
5. Locate the burner pressure test point on the main burner manifold.
 - Remove the test point screw and washer from the test point orifice.
 - Connect the manometer.
6. Carefully remove the plastic protective cover from in front of the PCB board. This is held in position with three holes in its top side and right side, engaging with three spigots in the PCB support housing.
7. Switch on the electrical supply at the power outlet to the water heater and turn on a controller, if one is fitted, by pressing the on / off (⏻) button.
8. Open the gas isolation valve fully at the gas inlet to the water heater, if not already open.
9. Open a hot tap slowly until the burners ignite.
10. Press and hold down the MIN button and observe the reading on the manometer.
 - "1L" is shown on the LED display.
11. Release the MIN button.

If the manometer reading observed in step 10 agrees with the rating label, no further adjustment is required.
12. To adjust, press and hold the adjuster button.
 - "LH" is shown on the LED display.
- Note:** The adjuster button must be held down continuously through steps 12 to 14.
13. Press and hold the MIN button and observe the reading on the manometer.
 - The manometer reading will change as the test point gas pressure adjusts.

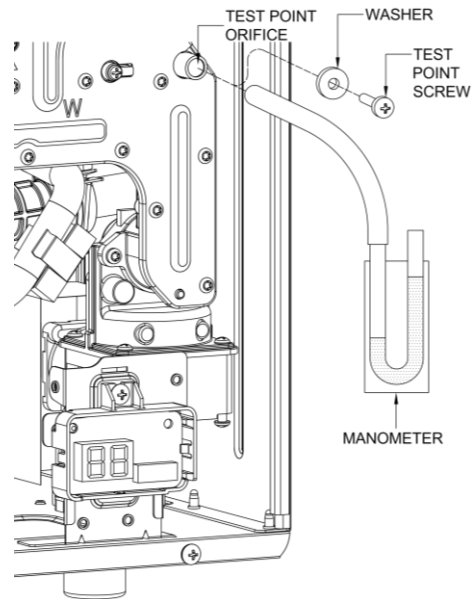

Step 5

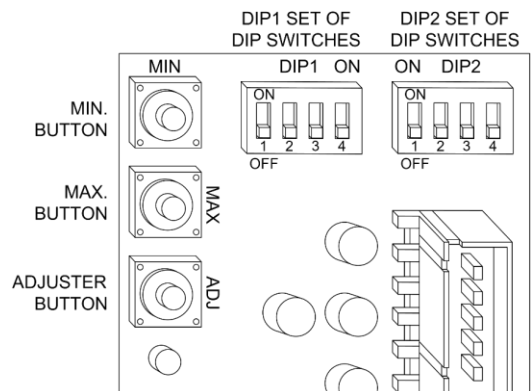

Step 10

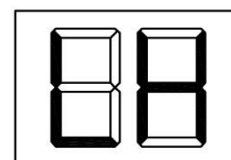
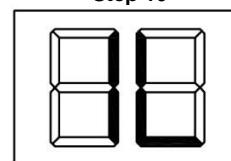

Step 12

Note: While the MIN button is pressed, the gas pressure will at first increase then decrease, cycling between an upper gas pressure limit (59 on the LED display) and a lower gas pressure limit (01 on the LED display).

14. Release the MIN button when the reading on the manometer agrees with the rating label.
15. Release the adjuster button.

Notes

- If the burners extinguish and error code 11 or 12 starts to flash on the LED display:
 - release the MIN and adjuster buttons
 - close the hot tap
 - clear the error code (refer to “[Clearing Error Code](#)” on page 43)
 - recommence the procedure from Step 9.
- If the adjuster button is released before Step 14, clear any error code (if displayed) and recommence the procedure from Step 9.

Maximum burner test point gas pressure

Refer to the rating label on the water heater for the maximum burner test point gas pressure.

Follow Steps 9 to 15 of the “[Minimum test point gas pressure](#)” procedure on page 42, but open the hot tap fully and use the MAX button instead of the MIN button. It may be necessary to open two or three hot taps fully, depending upon the model of water heater and the incoming cold water temperature.

Notes

- In Step 10, “6H” (B28 models) will be shown on the LED display.
- In Step 13, while the MAX button is pressed, the gas pressure will at first increase then decrease, cycling between an upper gas pressure limit (39 on the LED display) and a lower gas pressure limit (01 on the LED display).

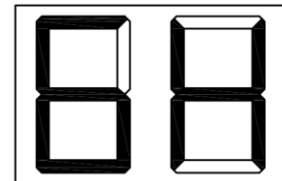

Step 10
max burner test point gas pressure

After setting the minimum and maximum test point gas pressures:

- Close the hot tap.
- Remove the manometer and refit and tighten the test point screw and washer.
- Open a hot tap again so the burners ignite.
- Test for gas leaks.
- Close the hot tap.
- Turn off the controller, if one is fitted, by pressing the on / off (⏻) button.
- Switch off the electrical supply at the power outlet to the water heater.
- Carefully replace the plastic protective cover over the front of the PCB board. Secure in position by engaging the three spigots in the PCB support housing through the three holes in the protective cover's top side and right side.
- Refit the front panel and screws to the water heater.

Clearing Error Code

If an error code does appear on the LED display during the commissioning process, it will be necessary to clear the error in order to complete the installation.

To clear an error code:

- switch off the electrical supply at the power outlet to the water heater.
- check the gas isolation valve at the gas inlet to the water heater is fully open.
- wait five (5) minutes.
- switch on the electrical supply at the power outlet to the water heater.

PRESET OUTLET TEMPERATURE SETTING

The factory preset outlet temperature setting of the water heater is:

- 874 series 60°C
- 876 series 50°C

If a temperature controller is connected to the water heater, this will override the preset outlet temperature setting and the maximum temperature setting will be:

Maximum Outlet Temperature	874 series	876 series
Kitchen controller connected	60°C	50°C
Bathroom controller only connected	50°C	50°C

It is usually not necessary to adjust the factory preset outlet temperature setting of the water heater, unless the customer has a particular requirement for this to be done or it is to be installed as an in-series gas booster to a solar water heater.

Refer to [“To Check or Adjust the Preset Outlet Temperature Setting”](#) on page 44 to check or if required to adjust the preset outlet temperature setting of the water heater.

Gas Booster for a Solar Water Heater

Note: Australian Standard AS 3498 requires that a water heater provides the means to inhibit the growth of Legionella bacteria in potable water. When this water heater is used as an in-series booster for a solar water heater it can satisfy the AS 3498 requirements provided it is energised, the booster preset outlet temperature setting is at least 70°C, and that a remote temperature controller is not used.

It will be necessary to check and if required to adjust the preset outlet temperature setting of the continuous flow water heater when:

- it is installed as an in-series gas booster to a solar water heater
- it is an existing continuous flow water heater and a solar water heater is then installed.

Notes

- Consideration must be given to the delivery temperature to any ablution and public areas such as a bathroom, ensuite or public amenities. Refer to [“Hot Water Delivery”](#) on page 23 and to [“Schematics of Two Temperature Zones Using A Temperature Limiting Device”](#) on page 24.
- The 876 series water heater, marked “THIS APPLIANCE DELIVERS WATER NOT EXCEEDING 50°C IN ACCORDANCE WITH AS 3498” on the front panel, **must not** be installed as an in-series gas booster to a solar water heater, as water temperature greater than 50°C can be delivered from the water heater contravening its compliance to AS 3498.

TO CHECK OR ADJUST THE PRESET OUTLET TEMPERATURE SETTING

The temperature settings will be displayed on the LED display. The preset outlet temperature settings are:

- 874 series 40°C, 42°C, 45°C, 50°C, 55°C, 60°C, 65°C, 70°C, 75°C
- 876 series 40°C, 42°C, 45°C, 50°C

It is necessary to have the electrical supply to the water heater switched on during stages of checking or adjusting the preset outlet temperature setting procedure.

⚠ Warning: The removal of the front panel will expose 220 - 240 V a.c. wiring. Take care not to touch wiring terminals. The adjustment must be carried out by a qualified person.

⚠ Warning: This procedure will involve the adjustment of dip switches and may involve the pressing of the MIN and MAX buttons. Adjustment of a dip switch or the pressing of the MIN and MAX buttons should only be made with an insulated tool.

To check or adjust the preset outlet temperature setting:

1. Switch off the electrical supply at the power outlet to the water heater.
2. Remove the screws holding the front panel to the jacket.
3. Gently disengage the front panel and pull forward to remove from the water heater.
4. Close the cold water isolation valve at the inlet to the water heater.

5. Carefully remove the plastic protective cover from in front of the PCB board. This is held in position with three holes in its top side and right side, engaging with three spigots in the PCB support housing.

6. Switch on the electrical supply at the power outlet to the water heater.

Note: Wait ten (10) seconds for the electronic system to initialise.

7. Switch dip switch 3 to the on (up) position on the DIP 1 set of DIP switches on the I.C. Board.

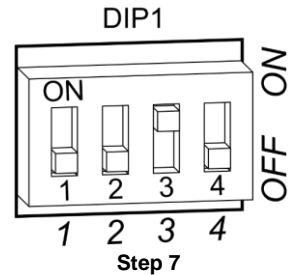

Step 7

The current preset outlet temperature setting will show on the LED display.

If the temperature displayed on the LED display is the desired preset outlet temperature setting, then proceed to step 9, as no further adjustment is necessary.

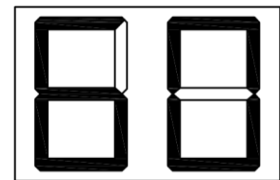

8. Press the MAX button to increase or the MIN button to decrease the preset outlet temperature setting.

Each press of the MAX or MIN button will increase or decrease the preset temperature by one increment.

The MAX and MIN buttons are located to the left of the DIP 1 and DIP 2 set of DIP switches.

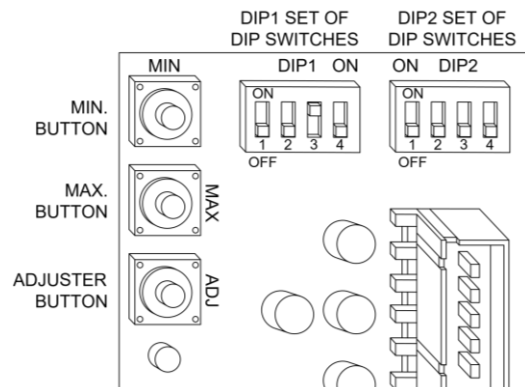

Step 8

874 series

The increments are 40°C, 42°C, 45°C, 50°C, 55°C, 60°C, 65°C, 70°C, 75°C.

876 series

The increments are 40°C, 42°C, 45°C, 50°C.

9. Switch dip switch 3 to the off (down) position.

The LED display will go blank.

Note: Wait ten (10) seconds for the setting to be saved. The preset outlet temperature setting is now set.

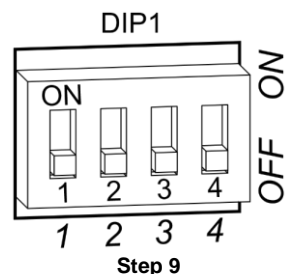

Step 9

10. Switch off the electrical supply at the power outlet to the water heater.

11. Carefully replace the plastic protective cover over the front of the PCB board.

- Secure in position by engaging the three spigots in the PCB support housing through the three holes in the protective cover's top side and right side.

12. Refit the front panel and screws to the water heater.

13. Open the cold water isolation valve fully at the inlet to the water heater.

14. Switch on the electrical supply at the power outlet to the water heater.

OUTLET TEMPERATURE COMPENSATION ADJUSTMENT

The outlet temperature compensation adjustment function is only applicable to:

- 876 series B28 water heaters

The maximum outlet temperature may be adjusted to compensate for temperature losses in the pipe work between the water heater outlet and fixtures used primarily for personal hygiene.

This procedure cannot be conducted on an 874 series water heater.

Warnings

- After adjustment, the water temperature from the first tap in the hot water pipe work used primarily for personal hygiene after the water heater, such as in a bathroom or ensuite, **MUST NOT** exceed:
 - The temperature displayed on a temperature controller connected to the water heater, or
 - 50°C if a temperature controller is not connected to an 876 series water heater.
- If there is a tap, such as a kitchen or laundry tap, in the hot water pipe work between the water heater and the first tap used primarily for personal hygiene, then it is possible for a water temperature to be delivered from that tap of up to 2°C higher than the setting shown on the controller.

Warnings

- It is necessary to have the electrical supply to the water heater switched on during stages of the outlet temperature compensation adjustment procedure.
- The removal of the front panel will expose 220 - 240 V a.c. wiring. Take care not to touch wiring terminals. The adjustment must be carried out by a qualified person.
- This procedure will involve the adjustment of dip switches and may involve the pressing of the MAX and MIN buttons. Adjustment of a dip switch or the pressing of the MAX and MIN buttons should only be made with an insulated tool.

Before Commencing the Procedure

This procedure cannot be conducted:

- If the preset outlet temperature is set below 50°C. The preset outlet temperature setting of the 876 series water heater must be set to 50°C. Refer to [“To Check or Adjust the Preset Outlet Temperature Setting”](#) on page 44.
- With a temperature controller connected to the water heater.
 - A temperature controller(s) connected to the water heater must be disconnected prior to the commencement of this procedure. Refer to Step 10 of the procedure on page 47.
- With an EZ Link system set up on the water heaters.
 - The EZ Link cable does not need to be disconnected.
 - The DIP switches need to be reset to the off (down) position on both water heaters prior to the commencement of this procedure. Refer to Step 11 of the procedure on page 47.
 - The Outlet Temperature Compensation Adjustment procedure has to be performed individually on both water heaters.
 - Whilst the procedure is being conducted on one water heater, the other water heater has to be isolated by turning off the cold water isolation valve to the water heater.

Outlet Temperature Adjustment

To adjust the outlet temperature:

1. Switch on the electrical supply at the power outlet to the water heater.
2. Locate the first hot tap in the hot water pipe work after the water heater used primarily for personal hygiene.
3. Turn on the hot tap.
4. Using a thermometer, measure the temperature of the water from the tap, until the temperature stops increasing.

If the water temperature is below 50°C, the maximum outlet temperature of the water heater can be adjusted upwards.

5. Turn off the hot tap.
6. Switch off the electrical supply at the power outlet to the water heater.
7. Remove the screws holding the front panel to the jacket.
8. Gently disengage the front panel and pull forward to remove from the water heater.
9. Carefully remove the plastic protective cover from in front of the PCB board, if it was not already removed during the disconnection of the wires of temperature controllers. This is held in position with three holes in its top side and right side, engaging with three spigots in the PCB support housing.
10. If a temperature controller(s) is connected, the cable terminal lugs must be disconnected from the terminals:

- Loosen the terminal screws to release the cable lugs.
- Withdraw the cable lugs, ensuring they are well clear of the terminals and other components.

11. If the water heater is part of an EZ Link system installation, reset the DIP switches to the off (down) position.

12. Switch on the electrical supply at the power outlet to the water heater.

Note: Wait ten (10) seconds for the electronic system to initialise.

13. Switch dip switches 1 and 2 to the on (up) position on the DIP 2 set of DIP switches on the I.C. Board.

The temperature setting of '48' will show on the LED display, if this has not previously been adjusted.

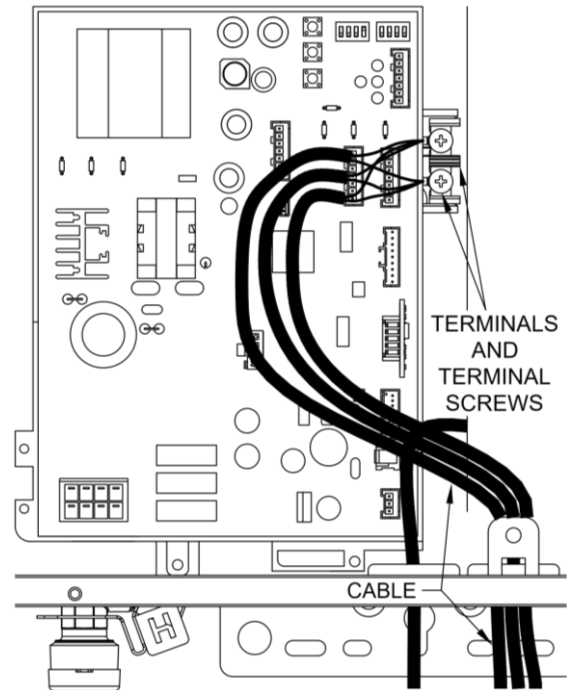

Step 10 – Disconnect the temperature controller cable(s) if a temperature controller is fitted.

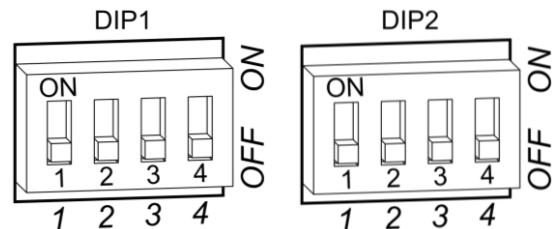

Step 11 – Reset DIP switches to off if EZ Link installed.

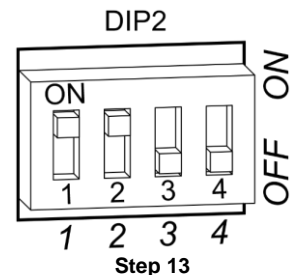

Step 13

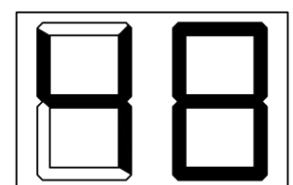

14. Press the MAX button once to increase the outlet temperature setting to the next increment.

The MAX button is located to the left of the DIP 1 and DIP 2 set of DIP switches and in between the MIN (top) and Adjuster (bottom) buttons.

Each press of the MAX button will increase the temperature setting by one increment.

The outlet temperature setting will show on the LED display.

The outlet temperature setting increments above 48°C are:

- 50°C, 51°C, 52°C, 53°C, 54°C.

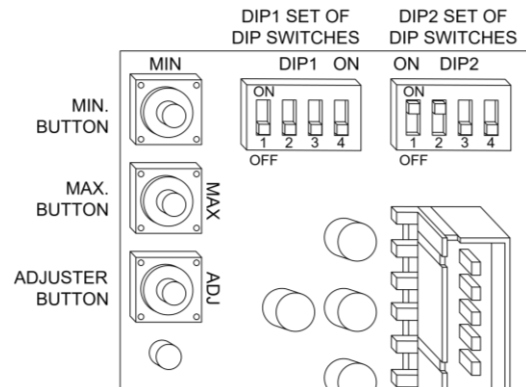

Step 14

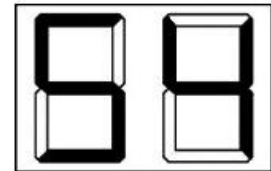

DIP2

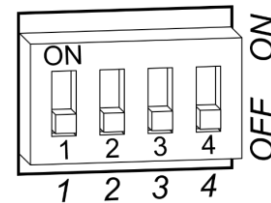

Step 15

15. Switch dip switches 1 and 2 to the off (down) position on the DIP 2 set of DIP switches on the I.C. Board.

The LED display will go blank.

Note: Wait ten (10) seconds for the setting to be saved.

16. Check the water temperature at the hot tap by repeating steps 2 to 5.

17. Further adjustment – Increase: If the water temperature is still below 50°C and requires to be increased, repeat steps 13, 14 and 15, followed by steps 2 to 5 until an acceptable water temperature not exceeding 50°C is measured at the same hot tap.

18. Further adjustment – Decrease: If the water temperature exceeds 50°C, then to decrease the temperature;

- switch dip switches 1 and 2 to the on (up) position on the DIP 2 set of DIP switches on the I.C. Board. The outlet temperature setting will show on the LED display.

- press the MIN button once to decrease the outlet temperature setting to the next increment.

Each press of the MIN button will decrease the outlet temperature by one increment.

The MIN (top) button is located to the left of the DIP 1 and DIP 2 set of DIP switches and above the MAX (middle) button.

- Switch dip switches 1 and 2 to the off (down) position on the DIP 2 set of DIP switches on the I.C. Board.

The LED display will go blank.

Note: Wait ten (10) seconds for the setting to be saved.

- repeat steps 2 to 5 to confirm the water temperature does not exceed 50°C.

19. Switch off the electrical supply at the power outlet to the water heater.

20. Reconnect the controller cables (if a temperature controller is fitted).

- Reposition the cable lugs onto the terminals, ensuring they are well clear of other components.
- Tighten the terminal screws to secure the cable lugs.

21. Reset the DIP switches if the water heater is part of an EZ Link system installation, by following steps 7 and 9 of the procedure “EZ Link Cable Connection” on page 37.

22. Carefully replace the plastic protective cover over the front of the PCB board. Secure in position by engaging the three spigots in the PCB support housing through the three holes in the protective cover’s top side and right side

23. Refit the front panel and screws to the water heater.

24. Switch on the electrical supply at the power outlet to the water heater.

TO TURN OFF THE WATER HEATER

If it is necessary to turn off the water heater on completion of the installation, such as on a building site or where the premises is vacant, then:

- Turn off the controller(s) (if fitted) by pressing the on / off (⏻) button.
The on / off operating light will go out and the priority light, if it is on, will go out.
- Switch off the electrical supply at the power outlet to the water heater (refer to note below).
- Close the gas isolation valve at the inlet to the water heater.
- Close the cold water isolation valve at the inlet to the water heater.
- Drain the water heater if there is a risk of freezing conditions occurring (refer to [“Draining The Water Heater”](#) on page 49).

Notes

- The frost protection system will be rendered inoperable if electrical power is not available at the water heater.
- Damage caused by freezing due to the unavailability of power at the water heater is not covered by the Rheem warranty (refer to [“Terms of the Rheem Warranty”](#) on page 4).
- If the power has been switched off to the water heater and there is a risk of freezing, then it is necessary to drain the water heater (refer to [“Draining the Water Heater”](#) on page 49).

DRAINING THE WATER HEATER

To drain the water heater:

- Turn off the water heater (refer to [“Turn Off The Water Heater”](#) on page 49).
- Open a hot tap (preferably the shower outlet).
- Unscrew the two drain plugs, one each at the cold water inlet and hot water outlet (874 series model) or 50°C limited outlet (876 series model), on the underside of the water heater.

Water will drain from the water heater.

- When water stops flowing from the water heater, close the hot tap.

Note: It is recommended not to screw the drain plugs back in, until the water heater is to be turned on again.

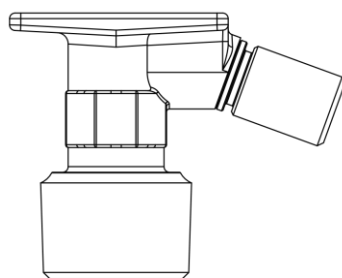

HOT WATER OUTLET

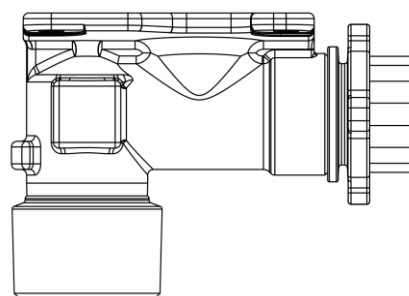

COLD WATER INLET

This page is intentionally blank.

This page is intentionally blank.



41413730000

Revision Date: 2024 April

(41-41373-00)

122356 Rev-01