

CAROMA

Forma II Under Counter Vanity Basin

35118

SPECIFICATIONS

Recommended Use	Domestic & Commercial
Material	Ceramic
Basin Colour	Gloss White
Bowl Capacity (L)	5.3L
Weight (kg)	8.2 kg
Taphole Configuration	0 tapholes
Overflow Included	Yes
Plug & Waste Included	Yes

WARRANTY

Warranty - Domestic Use (Years)	20 years
Spare Parts & Labour (Years)	1 year

Please refer to Warranty Page for full Terms and Conditions

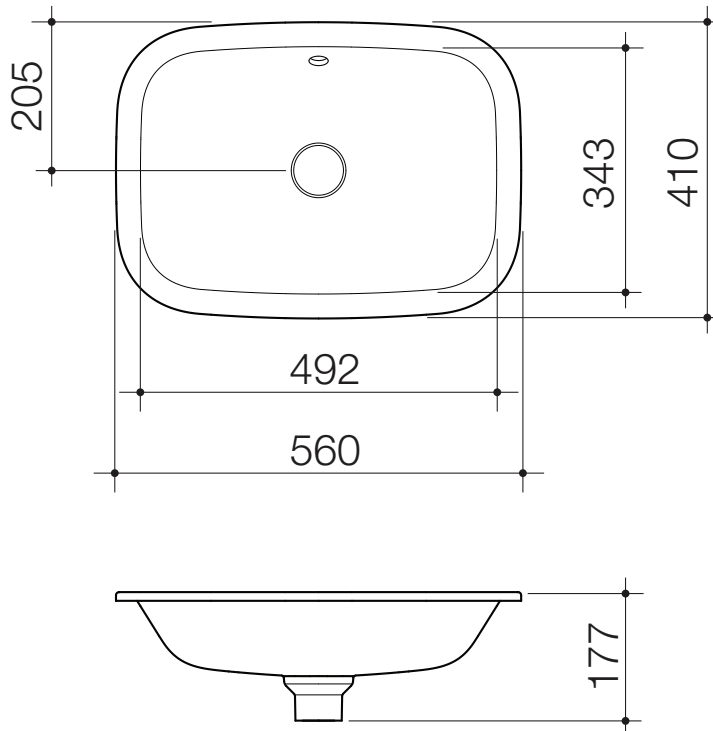

Dimensions are nominal measurements only.

CLEANING RECOMMENDATIONS:

We recommend the use of soapy water or approved cleaners. This product should not be cleaned with abrasive materials. Damage caused by any improper treatment is not covered by the product warranty. Refer to Warranty Conditions

Disclaimer: Products in this specification manual must by regulation be installed by licensed and registered trade people. The manufacturer/distributor reserves the right to vary specifications or delete models from their range without prior notification. Dimensions are nominal measurements only. Dimensions and set-outs listed are correct at time of publication however the manufacturer/distributor takes no responsibility for printing errors.

Published 29/01/2026 Rev. 0

To see the complete Forma II range go to
www.reece.com.au

