

AXA

HOX MINI COUNTER/WALL BASIN

RIGHT HAND AND REAR TAP HOLE MODELS

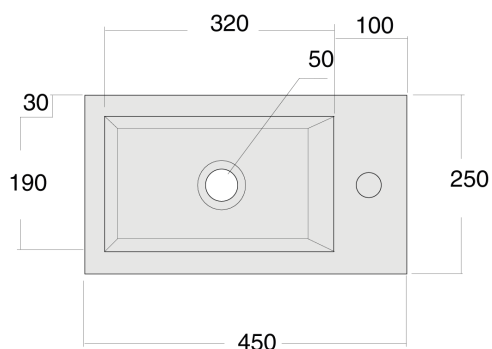

Right hand tap hole model

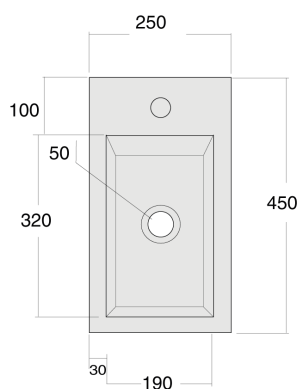

Rear tap hole model

SPECIFICATIONS

Recommended use	Domestic, hotel and commercial.
Material	Fine Fire Clay
Weight	6.5 kg
Fixing	To straight edged countertop joint sealed with waterproof sealant or bolted to wall
Integral overflow	No
Tap hole availability	1 tap hole (right hand or rear tap hole only)
Plug and waste	Suits 32 x 40mm non-overflow style waste (1852363)
Colour availability	White
Template	Supplied with product
Capacity	4 L

Dimensions are nominal measurements only.

To see the complete AXA range go to www.reece.com.au/bathrooms

CLEANING RECOMMENDATIONS

We recommend the use of soapy water or approved cleaners.

This product should not be cleaned with abrasive materials.

Damage caused by any improper treatment is not covered by the product warranty- refer to Warranty Conditions.

Disclaimer: Products in this specification manual must by regulation be installed by licensed and registered trade people. The manufacturer/distributor reserves the right to vary specifications or delete models from their range without prior notification. Dimensions are nominal measurements only. Dimensions and set-outs listed are correct at time of publication however the manufacturer/distributor takes no responsibility for printing errors.

Tech Page Version 4

AXA

HOX MINI COUNTER/WALL BASIN

INSTALLATION INSTRUCTIONS

Counter top installation

Rear of basin is punched for wall fixing bolts. Any counter top installation is recommended against the wall.

1. Use basin as cutout template and cut 20mm in from traced line.
2. Fit selected tapware and waste to basin. Ensure waste is siliconed around rim.
3. Apply waterproof sealant to rim of basin.
4. Locate basin complete with fittings onto bench top and press firmly all around.
5. Remove excess sealant.

Wall installation

If fixing to timber framed walls or partitioning the wall should be reinforced with noggin to receive fixing bolts.

1. Drill holes into wall at desired height and fixing centres and install fixing bolts supplied (see diagram c and d for fixing locations on basins).
2. Fit selected tapware to basin. Fit the waste to basin ensuring it is sealed with silicone on top.
3. Carefully align basin complete with fittings onto protruding bolts.
4. Insert nylon bushes and locking nuts supplied and partially tighten lock nuts to hold basin into position. Make minor adjustments at this stage and ensure basin is level and then fully tighten lock nuts. Do not over tighten.
5. If desired all visible external edges can be joint sealed using flexible sealant ensuring to wipe off any excess.

Right hand tap hole model

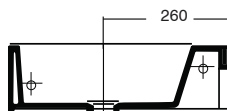
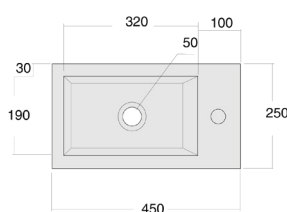

a)

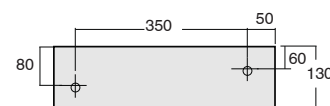

b) Right hand tap hole fixing bolt detail

Rear tap hole model

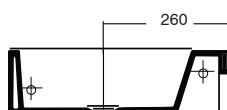
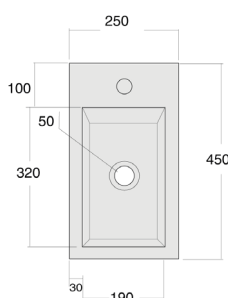

a)

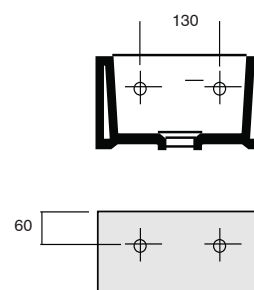

b) Rear tap hole fixing bolt detail

AXA

HOX MINI COUNTER/WALL BASIN



REECE PRODUCT QUALITY GUARANTEE

You have purchased a quality product from Reece Pty Ltd ABN 84 004 097 090 ("Reece"). This product is covered by a 15 year replacement product warranty and a 12 month warranty over spare parts and labour.

15 YEAR WARRANTY – DOMESTIC USE

This warranty covers faults in the product construction, material and assembly. Products which are within 15 years from the date of purchase, found upon inspection by an authorised Reece representative, to be defective in construction, material or assembly, will be repaired or exchanged with an equivalent product free of charge. Replaced items become Reece's property.

All replacement products will be available for collection without charge to the customer at the nearest Reece branch to the customer's location, or elsewhere as agreed between the customer and Reece.

Labour and Spare Parts

The labour for the replacement of products and spare parts to which this warranty applies will be supplied by Reece or relevant supplier using licensed plumbers engaged by Reece or relevant supplier within 1 year from the date of purchase.

Spare parts which are within 1 year from the date of purchase found upon inspection by an authorised Reece representative to be defective in construction, material or assembly, will be replaced free of charge.

Warranty Conditions

This warranty will apply only under all of the following conditions:

- The item has been installed by a licensed plumber
- The item has been installed for and subjected to domestic residential use only
- Failure is due to a fault in the manufacture of the product
- Proof of purchase (including the date of purchase) is provided
- The installation of the product is in accordance with the instructions provided

This warranty does not cover products purchased as an ex-display without being fully checked and tested for sale by the manufacturer.

This warranty does not include faults caused by:

- Unsuitable or improper use
- Incorrect installation or installation not in accordance with the instructions provided
- Installation or part installation by the purchaser or any person other than a LICENSED PLUMBER
- Normal wear and tear
- Inadequate or complete lack of maintenance
- Chemical, electrochemical or electrical influences
- Harsh detergents or abrasive cleaners used on product finishes

1 YEAR WARRANTY – COMMERCIAL USE

'Commercial' use is all use other than for normal domestic residential purposes, including use in non-business places as in public buildings, schools, sports centres and in establishments that contain private bathrooms with high frequency of use by many individuals, such as hotels, motels, retirement villages and hospitals.

The Commercial warranty covers this product against manufacturing faults in the construction, material and assembly of both the finished products and any spare parts for a period of 1 year from the date of purchase. Products and spare parts which are found upon inspection by an authorised Reece representative to be defective in construction, material or assembly will be repaired or exchanged free of charge. Replaced items become Reece's property. The labour for the replacement of products and spare parts to which this warranty applies will be supplied by Reece or relevant supplier using licensed plumbers engaged by Reece or relevant supplier. The Warranty Conditions and exclusions which apply to the domestic use warranty also apply to this commercial warranty.

EXCLUSIONS

To the fullest extent permitted by law, Reece excludes all liability for damage or injury to any person, damage to any property, and any indirect consequential or other loss or damage.

CLAIM PROCEDURE

For all warranty queries customers are to contact the branch where the product was purchased. These details can be found on your purchase invoice.

Our goods come with guarantees that cannot be excluded under the Australian Consumer Law. You are entitled to a replacement or refund for a major failure and for compensation for any other reasonably foreseeable loss or damage. You are also entitled to have the goods repaired or replaced if the goods fail to be of acceptable quality and the failure does not amount to a major failure.

Don't risk it, use a licensed plumber.™

