

TA-COMPACT-P



Combined control & balancing valves for small terminal units

Pressure independent balancing and control valve (PIBCV)



Engineering
GREAT Solutions

TA-COMPACT-P

The pressure independent balancing and control valve TA-COMPACT-P ensures optimum performance over a long life. Adjustable maximum flow enables design flow and eliminates over flows for accurate hydronic control. The TA-COMPACT-P together with our balancing instruments enables advanced measuring and diagnostics.

Key features

- > **Precise hydronic balancing**
Smoothly adjustable setting of max. flow prevents over flow through terminal unit.
- > **Installations without limits**
Slim and compact shape simplifies installation, one side access to all functions simplifies operation.
- > **Full control of the system**
Exact flow measuring and unique diagnostic functions for ultimate energy savings and highly reliable system.
- > **High reliability**
AMETAL® and stainless steel guarantees high corrosion resistance and reduces the risk of leakage.



Technical description

Application:

Heating and cooling systems.

Functions:

Control
Pre-setting (max. flow)
Differential pressure control
Measuring (ΔH , T, q)
Isolation (for use during system maintenance – see also Leakage rate)

Dimensions:

DN 10-32

Pressure class:

PN 16

Differential pressure (ΔpV):

Max. differential pressure (ΔpV_{max}): 400 kPa = 4 bar

Min. differential pressure (ΔpV_{min}):

DN 10-20: 15 kPa = 0,15 bar

DN 25-32: 23 kPa = 0,23 bar

(Valid for position 10, fully open. Other positions will require lower differential pressure, check with the software HySelect.)

ΔpV_{max} = The maximum allowed pressure drop over the valve to fulfill all stated performances.

ΔpV_{min} = The minimum recommended pressure drop over the valve, for proper differential pressure control.

Flow range:

The flow (q_{max}) can be set within the range:

DN 10: 21,5 - 120 l/h

DN 15 LF: 44 - 245 l/h

DN 15: 88 - 470 l/h

DN 20: 210 - 1150 l/h

DN 25: 370 - 2150 l/h

DN 32: 800 - 3700 l/h

q_{max} = l/h at each setting and fully open valve plug.

LF = Low flow

Temperature:

Max. working temperature: 90°C

Min. working temperature: -10°C

Media:

Water or neutral fluids, water-glycol mixtures (0-57%).

Lift:

4 mm

Leakage rate:

Leakage flow $\leq 0,01\%$ of max. q_{max} (setting 10) and correct flow direction. (Class IV according to EN 60534-4).

Characteristics:

Linear, best suited for on/off control.

Material:

Valve body: AMETAL®

Valve insert: AMETAL®

Valve plug: Stainless steel

Spindle: Stainless steel

Spindle seal: EPDM O-ring

Δp insert: PPS

Membrane: EPDM and HNBR

Springs: Stainless steel

O-rings: EPDM

AMETAL® is the dezincification resistant alloy of IMI Hydronic Engineering.

Marking:

TA, IMI, PN 16, DN and flow direction arrow.

Grey handwheel: TA-COMPACT-P and DN. For low flow version also LF.

Connection:

Male thread according to ISO 228.

Connection to actuator:

M30x1.5

Actuators:

See separate technical documentation on EMO T.

Measuring accuracy

Maximum flow deviation at different settings

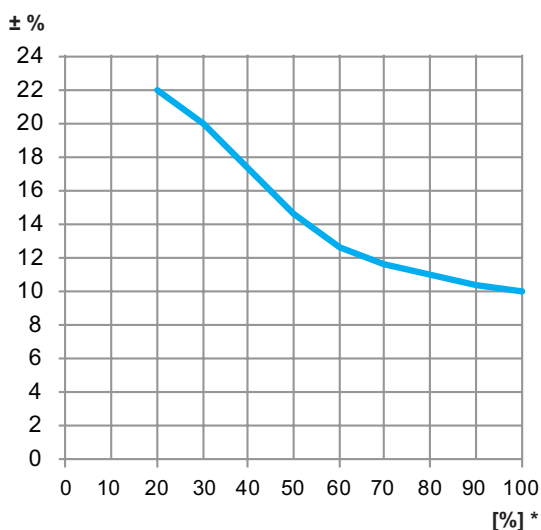

*) Setting (%) of fully open valve.

Correction factors

The flow calculations are valid for water (+20°C). For other liquids with approximately the same viscosity as water (≤ 20 cSt = $3^\circ E=100S.U.$), it is only necessary to compensate for the specific density. However, at low temperatures, the viscosity increases and laminar flow may occur in the valves. This causes

a flow deviation that increases with small valves, low settings and low differential pressures. Correction for this deviation can be made with the software HySelect or directly in our balancing instruments.

Noise

In order to avoid noise in the installation, the valve must be correctly installed and the water de-aerated.

Actuators

Actuator EMO T

For more details of EMO T, see separate catalogue leaflet. TA-COMPACT-P is developed to work together with the EMO T actuator. Actuators of other brands require;
Working range: X (closed - fully open) = 11,6 - 15,8
Closing force: Min. 125 N (max. 500 N)

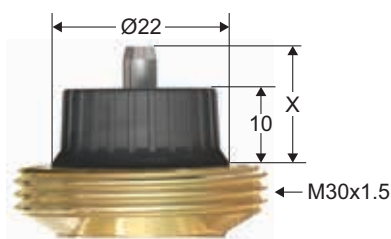

IMI Hydronic Engineering will not be held responsible for the control function if other brands of actuator are used.

Maximum recommended pressure drop (ΔpV) for valve and actuator combination

The maximum recommended pressure drop over a valve and actuator combination for close off (ΔpV_{close}) and to fulfill all stated performances (ΔpV_{max}).

DN	EMO T * [kPa]
10	400
15	
20	
25	
32	

*) Closing force 125 N.

ΔpV_{close} = The maximum pressure drop that the valve can close against from an opened position, with a specified force (actuator) without exceeding stated leakage rate.

ΔpV_{max} = The maximum allowed pressure drop over the valve to fulfill all stated performances.

Sizing

1. Choose the smallest valve size that can obtain the design flow with some safety margin, see " q_{max} values". The setting should be as open as possible.
2. Check that the available ΔpV is within the working range 15-400 kPa or 23-400 kPa.

q_{max} values

	Position									
	1	2	3	4	5	6	7	8	9	10
DN 10	21,5	39,5	54,0	68,5	80,0	91,0	99,0	107	113	120
DN 15 LF	44,0	71,0	97,0	123	148	170	190	210	227	245
DN 15	88,0	150	200	248	295	340	380	420	450	470
DN 20	210	335	460	575	680	780	890	990	1080	1150
DN 25	370	610	830	1050	1270	1490	1720	1870	2050	2150
DN 32	800	1220	1620	2060	2450	2790	3080	3350	3550	3700

q_{max} = l/h at each setting and fully open valve plug.
LF = Low flow

Installation

Application example

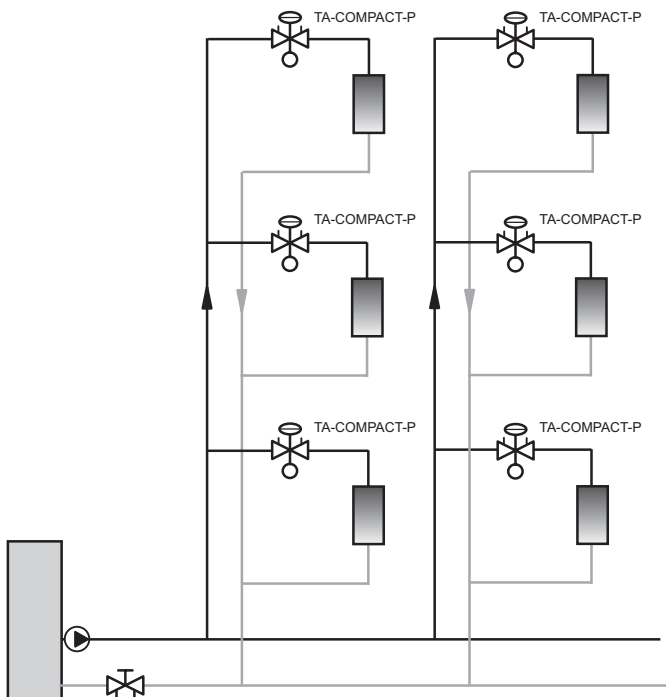

Installation of actuator EMO T

Approx. 15 mm of free space is required above the actuator.

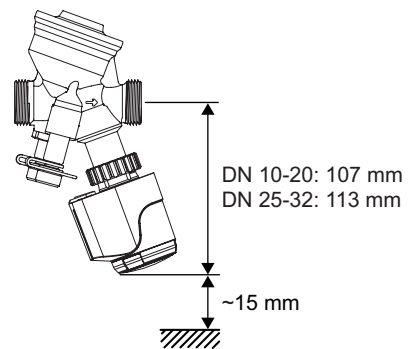

TA-COMPACT-P + EMO T

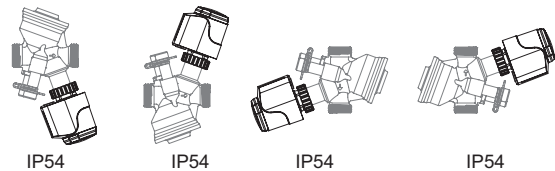

Flow direction

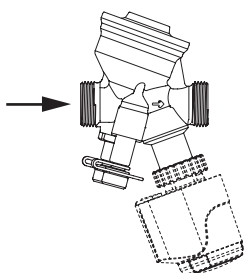

Operating function

Setting

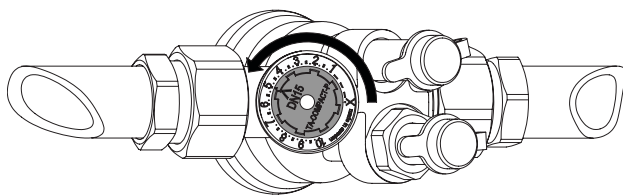

1. Turn the setting wheel to desired value, e.g. 5.0.

Shut-off

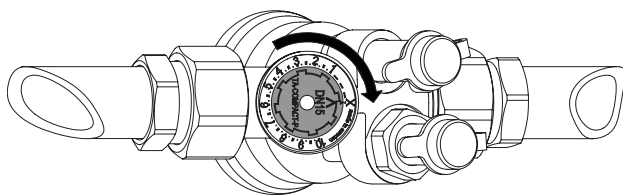

1. Turn the setting wheel clockwise to X.

Measuring q

1. Remove the installed actuator.
2. Connect the TA's balancing instrument to the measuring points.
3. Input the valve type, size and setting and the actual flow is displayed.

Measuring ΔH

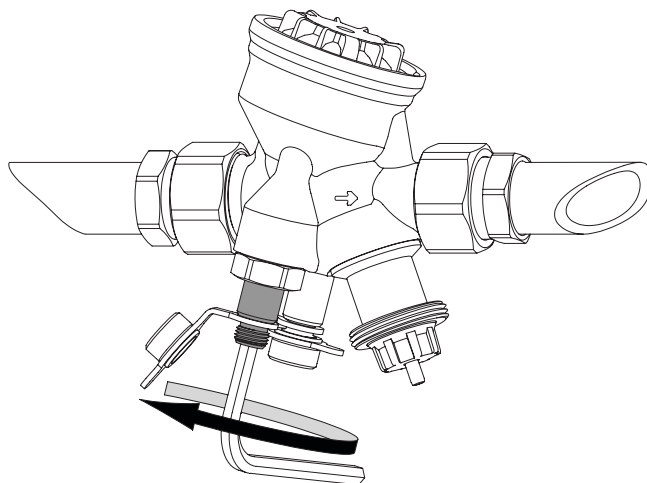

1. Remove any actuator.
2. Close the valve according to "Shut-off".
3. Bypass the Δp -part by opening the bypass spindle ≈ 1 turn anticlockwise, with a 5 mm Allen key.
4. Connect TA's balancing instrument to the measuring points and measure.

Important! Reopen the valve to previous setting and close the bypass spindle after the measurement is completed.

Articles

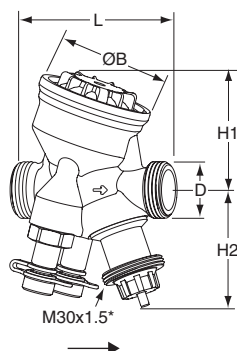

Male thread

Threads according to ISO 228

DN	D	L	H1	H2	B	q _{max} [l/h]	Kg	EAN	Article No
10	G1/2	74	55	55	54	120	0,53	7318794013308	52 164-010
15 LF	G3/4	74	55	55	54	245	0,54	7318794025202	52 164-115
15	G3/4	74	55	55	54	470	0,54	7318794013407	52 164-015
20	G1	85	64	55	64	1150	0,69	7318794013506	52 164-020
25	G1 1/4	93	64	61	64	2150	0,79	7318794013605	52 164-025
32	G1 1/2	112	78	61	78	3700	1,5	7318794013704	52 164-032

LF = Low flow

*) Connection to actuator.

→ = Flow direction

Connections

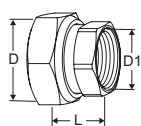

With female thread

Threads according to ISO 228. Thread length according to ISO 7-1.

Swivelling nut

Brass/AMETAL®

Valve DN	D	D1	L*	EAN	Article No
10	G1/2	G3/8	21	7318794016804	52 163-010
15	G3/4	G1/2	21	7318794016903	52 163-015
20	G1	G3/4	23	7318794017009	52 163-020
25	G1 1/4	G1	23	7318794017108	52 163-025
32	G1 1/2	G1 1/4	31	7318794017207	52 163-032

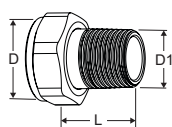

With male thread

Threads according to ISO 7-1.

Swivelling nut

Brass

Valve DN	D	D1	L*	EAN	Article No
10	-	-	-	-	-
15	G3/4	R1/2	29	4024052516612	0601-02.350
20	G1	R3/4	32,5	4024052516810	0601-03.350
25	G1 1/4	R1	35	4024052517015	0601-04.350
32	G1 1/2	R1 1/4	38,5	4024052517213	0601-05.350

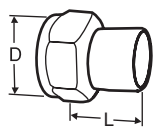

Welding connection

Swivelling nut

Brass/Steel 1.0045 (EN 10025-2)

Valve DN	D	Pipe DN	L*	EAN	Article No
10	G1/2	10	30	7318792748400	52 009-010
15	G3/4	15	36	7318792748509	52 009-015
20	G1	20	40	7318792748608	52 009-020
25	G1 1/4	25	40	7318792748707	52 009-025
32	G1 1/2	32	40	7318792748806	52 009-032

*) Fitting length (from the gasket surface to the end of the connection).

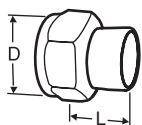

Soldering connection

Swivelling nut

Brass/gunmetal CC491K (EN 1982)

Valve DN	D	Pipe Ø	L*	EAN	Article No
10	G1/2	10	10	7318792749100	52 009-510
10	G1/2	12	11	7318792749209	52 009-512
15	G3/4	15	13	7318792749308	52 009-515
15	G3/4	16	13	7318792749407	52 009-516
20	G1	18	15	7318792749506	52 009-518
20	G1	22	18	7318792749605	52 009-522
25	G1 1/4	28	21	7318792749704	52 009-528
32	G1 1/2	35	26	7318792749803	52 009-535

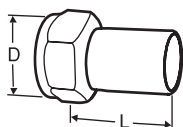

Connection with smooth end

For connection with press coupling

Swivelling nut

Brass/AMETAL®

Valve DN	D	Pipe Ø	L*	EAN	Article No
10	G1/2	12	35	7318793810502	52 009-312
15	G3/4	15	39	7318793810601	52 009-315
20	G1	18	44	7318793810700	52 009-318
20	G1	22	48	7318793810809	52 009-322
25	G1 1/4	28	53	7318793810908	52 009-328
32	G1 1/2	35	59	7318793811004	52 009-335

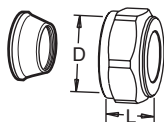

Compression connection

Support bushes shall be used, for more information see catalogue leaflet FPL.

Should not be used with PEX pipes.

Brass/AMETAL®

Chrome plated

Valve DN	D	Pipe Ø	L**	EAN	Article No
10	G1/2	8	16	7318793620002	53 319-208
10	G1/2	10	17	7318793620101	53 319-210
10	G1/2	12	17	7318793620200	53 319-212
10	G1/2	15	20	7318793620309	53 319-215
10	G1/2	16	25	7318793620408	53 319-216
15	G3/4	15	27	7318793705006	53 319-615
15	G3/4	18	27	7318793705105	53 319-618
15	G3/4	22	27	7318793705204	53 319-622

*) Fitting length (from the gasket surface to the end of the connection).

**) Over all length L refers to unassembled coupling.

Accessories

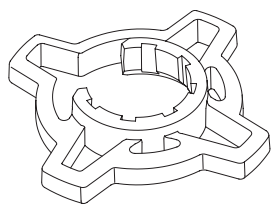

Grip for setting wheel, optional

For better grip when presetting.

For TA-COMPACT-P/-DP and TA-Modulator (DN 15-32).

Colour	EAN	Article No
Orange	7318794040502	52 164-950

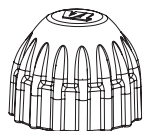

Protection cap

For TA-COMPACT-P/-DP, TA-Modulator (DN 15-20), TBV-C/-CM.

Colour	EAN	Article No
Red	7318793961105	52 143-100

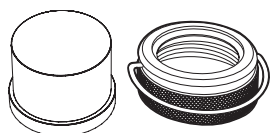

Tamper proof cover

Set containing plastic cover and locking ring for valves with connection M30x1,5 to thermostatic head/actuator.

Prevents manipulation of setting.

Colour	EAN	Article No
	7318794030206	52 164-100

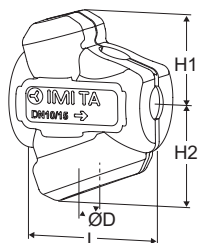

Insulation

For heating/comfort cooling.

Material: EPP.

Fire class: E (EN 13501-1), B2 (DIN 4102).

Valve DN	L	H1	H2	D	EAN	Article No
10-15	100	61	71	84	7318794027404	52 164-901
20	118	67	79	90	7318794027503	52 164-902
25	127	71	84	104	7318794027602	52 164-903
32	154	85	99	124	7318794027701	52 164-904

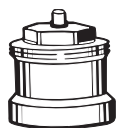

Spindle extension

Recommended together with the insulation to minimize the risk of condensation at the valve-actuator interface.

M30x1,5.

L	EAN	Article No
Plastic, black		
30	4024052165018	2002-30.700