



Suitability:

Suitable for domestic and commercial installations to remove sediment and improve the service life of plumbing fixtures and fittings. Product Approval:

The product is certified to ATS 5200.103



BWT Infinity[®] A

Automatic Backwash Filter
90 micron sediment filter
Complete with dual check valve,
backflow prevention and timer control

1-510317 / 14418 / 2022-09 / © reece / Printed in Germany

Changes reserved!



For You and Planet Blue.



Thank you very much for the confidence that you have shown in us by purchasing a BWT appliance.



Table of Contents

1	About This Documentation	4
1.1	Validity of this documentation	4
1.2	Symbols used	4
2	Safety Instructions	4
2.1	General safety instructions	4
2.2	Product-specific safety instructions	5
2.3	Personnel qualifications	5
3	Transport, Installation	5
4	Performance description	5
4.1	Intended use	5
4.2	Foreseeable misuse	5
4.3	Disclaimer	5
4.4	Other applicable documentation	5
5	Scope of supply	6
5.1	Intended Use	6
5.2	Suitable Applications	6
6	Function	7
7	Installation conditions	7
8	Installing the Filter	8
8.1	Connecting to the Connection Module	8
8.2	Wastewater Connection	8
9	Commissioning the Filter	9
9.1	Setting the timer	9
9.2	For parallel operation only	10
10	Operation	10
10.1	Setting the backwash interval	10
10.2	Manual backwashing	10
10.3	Display	10
10.4	Cleaning	10
11	Maintenance	11
11.1	Troubleshooting	11
12	Technical data	12
12.1	Pressure Drop/Flow Rate	13
12.2	Type label	14
13	Warranty	15
14	Decommissioning and disposal	15
14.1	Decommissioning	15
14.2	Disposal	15

1 About This Documentation

1.1 Validity of this documentation

This documentation is valid for the following product:

Infinity A backwash filter

This documentation is intended for operators, end users, installation technicians not trained by BWT, installation technicians trained by BWT (e.g. "Trinkwasserprofi" or drinking water specialists) and BWT service technicians.

This documentation contains important information about how to safely and properly install the product, how to start up, operate, use, maintain and dismantle the product as well as how to remedy simple faults on your own.

Please read this documentation in its entirety before working with the product, especially section 2, Safety Instructions, on page 4.

1.2 Symbols used

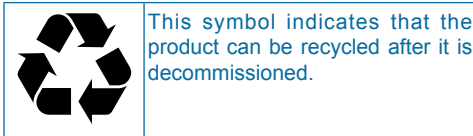

2 Safety Instructions

The product was manufactured according to all recognised regulations and technical standards and was in compliance with the relevant legal requirements when it was put into circulation. Nevertheless, it can pose a risk of personal injury or property damage if you do not observe this chapter and the safety instructions throughout this documentation.

- Carry out only those activities that are described in this operating manual, unless you have been trained by BWT.
- Carry out all activities in accordance with all applicable standards and requirements.
- Instruct the operator of the product on the product's function and how to use it.
- Inform the operator of the product about how to maintain the product.
- Inform the operator of the product about the possible hazards that may arise when operating the product.

2.1 General safety instructions

- Read this documentation carefully and in its entirety before working with the product.
- Store this documentation so that it is accessible to all users at all times.
- Include the complete documentation if you transfer the product to a third party.
- Follow all instructions regarding proper use of the product.
- If you notice damage to the product or the mains supply line, cease operation immediately and inform the service personnel.
- Use only accessories, spare parts and consumables that have been approved by BWT.
- Adhere to the environmental and operating conditions specified in the "Technical Data" section.
- Wear personal protective equipment. This equipment is for your own safety and will protect you from injury.

2.2 Product-specific safety instructions

In the following sections, you will find product-specific safety instructions whenever you must perform certain safety-relevant actions on the device.

2.3 Personnel qualifications

The installation activities described in this manual require basic knowledge of mechanics, hydraulics and electrical systems as well as knowledge of the technical terminology associated with those fields.

To ensure safe installation, these activities may only be carried out by a specialist or by a trained person who is under the direction of a specialist.

A specialist is defined as someone who has the technical training, knowledge and experience as well as the knowledge of applicable regulations required to properly assess the work assigned to him/her, identify possible hazards and take appropriate safety measures. Specialists must comply with applicable, industry-specific regulations.

3 Transport, Installation

Transport the system as a complete unit, if possible. If you must dismantle the system before transport, check that all individual parts are present.

If there is a risk of frost, drain all components that convey water.

Lift or transport the system or system components only from the intended suspension eyes or attachment points.

The system must be placed on a horizontal surface or mounted to a vertical surface that is sufficiently flat and has a sufficient load-bearing capacity. It must be secured so that it does not fall or tip over.

4 Performance description

4.1 Intended use

The Inifinity backwash filters are used for filtration of drinking and industrial water to protect the water mains and the connected fittings, equipment, machinery, tanks, boilers and production facilities from malfunction and corrosion damage caused by foreign particles.

The filters can also be used for filtration of well, process, boiler feed, cooling and air conditioning water. In these cases, advice must be obtained from a specialist.

The filters are unsuitable for oils, greases, solvents, soaps and other lubricating media. Water-soluble substances also cannot be separated off.

4.2 Foreseeable misuse

Operating the system with parameters other than those specified in this documentation and in section 4.1.

Not adhering to the prescribed maintenance and service intervals.

Using spare parts and consumables not approved by BWT.

4.3 Disclaimer

The manufacturer is released from any liability if the customer intentionally or forcibly removes guards or safety devices, if the customer wilfully modifies or circumvents the same, or if the customer does not follow the instructions in this operating manual or on the system.

4.4 Other applicable documentation

Observe all documents from suppliers that were included with delivery. These are considered part of this documentation and must not be changed or removed.

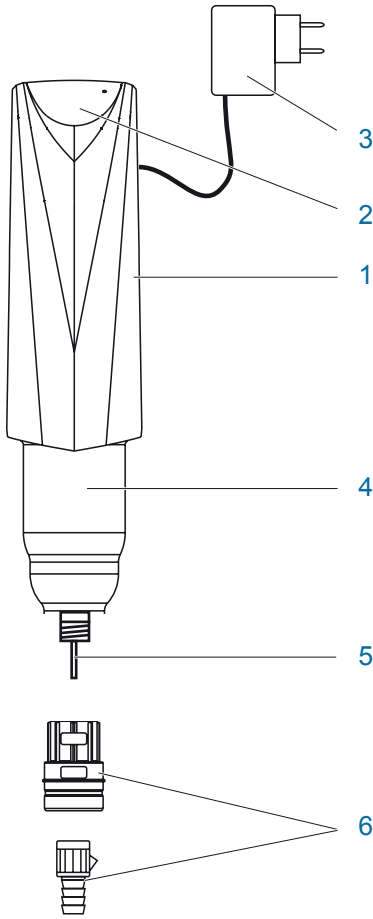

5 Scope of supply

BWT Infinity A consisting of:

1	Outer casing with DR brass body
2	Electronic programmable controller
3	Power supply unit (240 V AC / 24 V DC - IP40) and connection cable
4	Transparent bowl with filter element
5	Vent tube
6	Wastewater connections
7	Connection module complete with dual check valve and seals.
A	DN 20, DN 25 and DN 32, push and turn connection
B	DN 40 & DN 50 bolt flanged connection

5.1 Intended Use

The filters are primarily intended for filtering sediment from water.

They protect plumbing fixtures and fittings from malfunctioning, and against damage caused by foreign particles such as rust, swarf and sand.

The filters are not intended for use with chemically treated circulating water.

The filters are not suitable for oil, fat, solvents, soap, and other lubricating media, nor for separating water-soluble substances.

5.2 Suitable Applications

- Domestic water supply
- Commercial use and high rise buildings
- Industrial
- Food preparation areas and beverage equipment as a pre-filter

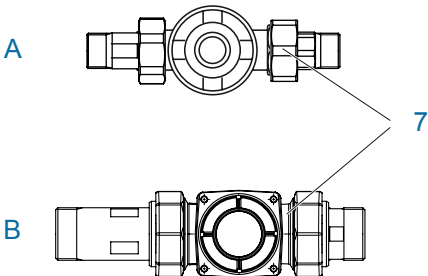

6 Function

Untreated water flows through the filter where impurities > 90 µm are trapped by the filter screen and removed. The filter screen can be cleaned by backwashing as required.

The backwash filter has patented suction-ring backwashing system that removes debris from the filter screen.

The unit timer is set by the installer and is used to set the interval between the backwashing cycle, of between one hour to 56 days, depending on incoming water quality.

The backwashing process does not interrupt the supply of water to plumbing fixtures.

7 Installation conditions

1. The unit must be installed by a licenced tradesperson to AS/NZS 3500.
2. A connection must be available for draining the flushing water.
3. There must be a 240 V / 50 Hz mains power point installed above the filter within 1.2 m to provide the unit with electrical power.
4. The power supply unit and filter are only suitable for dry location installation.
5. The filter installation must be protected against freezing conditions, solvent vapours, fuel oil, chemicals of all kinds, UV radiation, and heat sources above 40 °C. A cover is recommended where the filter is exposed to direct sun-light.
6. If the unit has been dropped or damaged, plastic parts must be replaced, even if there is no visible damage.

8 Installing the Filter

Install the filter in the cold water pipes upstream of the plumbing fixtures to be protected.

Install isolating valves when required. Install the connection module in correct flow direction as indicated by the arrow on the connection module.

Install support bracketing as required. To reduce plumbing noise, rubber lined, insulated clips are recommended.

DN 20, DN 25 & DN 32

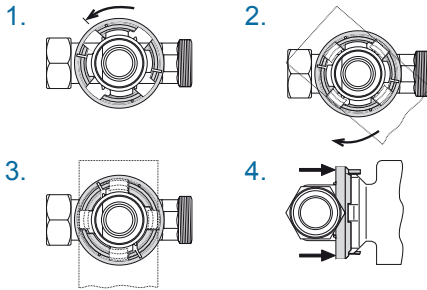

DN 40 & DN 50

Filter body showing gasket seal location

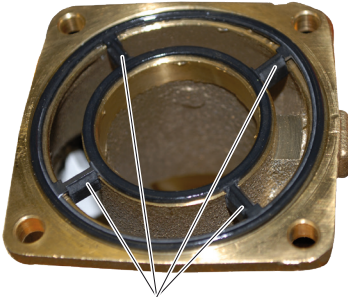

Align locating lugs and press gasket into groove

8.1 Connecting to the Connection Module

DN 20, DN 25 & DN 32:

1. Turn the black retaining ring to the left limit stop
2. Press the prongs of the device into the spaces provided
3. Rotate the device clockwise 45° to the limit and stop
4. Pull the black retaining ring with both hands towards the device until it clicks into place. The device cannot be rotated unintentionally.

To release the filter, press the retaining ring towards the connection module.

DN 40 & DN 50:

1. Lubricate gasket and fit to filter body. Align locating lugs and press gasket into groove.
2. Screw the filter onto the connector using four screws and washers provided.
3. Tighten the screws evenly and crosswise.

8.2 Wastewater Connection

Run hose connection to drain using flexible hose (not supplied).

For unplumbed test, provide a collection basin of approximately 15 litres capacity.

Please note:

The flushing water hose must be installed at a minimum distance of 40 mm above the highest possible waste water level (free discharge).

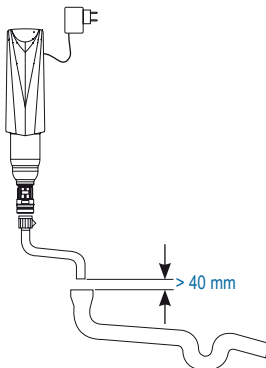

9 Commissioning the Filter

Slowly open the isolating valve(s) and de-aerate the pipework. Check the seals of the installation and filter for leaks.

Before connecting to power, check the filter discharge is connected to the drain.

Insert the cable plug connector of the power supply unit into the socket marked 24 V DC. Plug in power supply unit with plug (3) to mains power point.

As soon as the power is connected, the first backwashing cycle is performed automatically.

The illuminated display is activated during backwashing.

The default factory setting $\bar{7} \bar{d}$ (7 days) will appear first. The filter is capable of backwashing hourly, daily or weekly up to 56 days.

It is recommended to program the filter so that the device is backwashed at least once a month to avoid the build-up of foreign particles on the filter screen, or more frequently if required.

In case of power loss the filter will backwash automatically once the power supply is reconnected. Minimum operating pressure is 350 kPa.

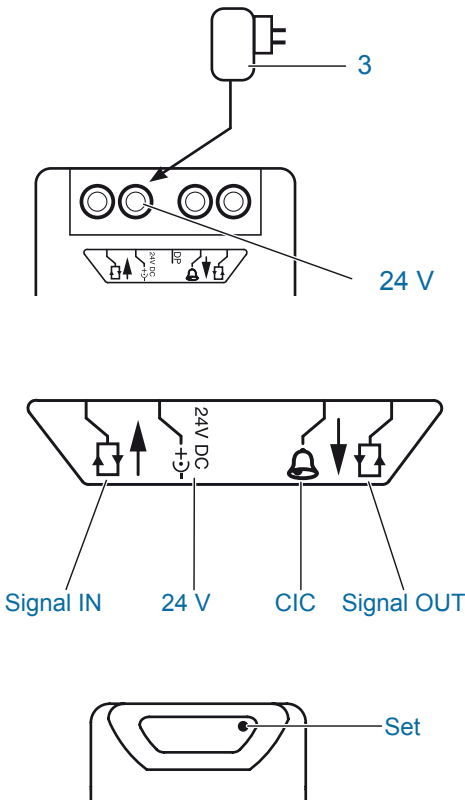

9.1 Setting the timer

1. Press SET for 5 seconds.
2. Display dots (3) appear: device is in programming mode.
3. Press and hold the SET key to step up the number of hours (h) or days (d).
4. The hours (h) run from 1 - 24, followed by days (d) from 2 - 56, followed by the hours again.
5. Hold the SET key until the desired setting has been reached, then let go.
6. The setting is saved 10 seconds after the last input.
7. The display dots disappear: the unit backwashes automatically (display of 3 bars rotate around the screen).
8. The display returns to programmed settings when backwash has completed.
9. The timer is now programmed.
10. The unit will display and countdown the time until the next backwash.

9.2 For parallel operation only

When 2, 3 or a maximum of 4 filters are operated in parallel, they must be electrically interlocked to prevent simultaneous backwashing.

Insert an interlocking cable into the output of any one filter, representing filter 1, and run the cable to the input of filter 2. Insert the next interlocking cable into the output of filter 2, and run it to the input of filter 3. The output of the last filter is returned to the input of filter 1.

The required backwash interval must be set at the filter to be backwashed first (master) (see above).

The second filter (slave) must be set as follows:

Key	Display
Press Set for 5 seconds	SL 0
Display dots flash - device is in programming mode	
Press Set	SL 1
Wait 10 seconds, dots stop flashing.	
The pressure appears in the display (0.0 P, when no water is used).	

A third filter must be set to SL 2 and a fourth to SL 3. Disconnect and reconnect all filters to the mains power supply. The filters will be backwashed in sequence: Master, SL 1, SL 2 and SL 3.

The time until the next backwashing and the pressure difference appear alternately in the master filter display. The pressure difference is only displayed for large volumes of water.

Only the pressure difference appears in the slave filter display.

The filters are ready for use.

10 Operation

We recommend programming the filter so that the device is backwashed at least once a month to prevent foreign particles from adhering to the filter element (more frequently for higher levels of soiling; factory setting every 7 days).

10.1 Setting the backwash interval

Should the local water quality (degree of contamination) change, the backwashing interval must be corrected; see commissioning.

10.2 Manual backwashing

Unplugging and plugging in the device can backwash it at any time.

10.3 Display

The time until the next backwashing and the pressure difference appear alternately in the display. The pressure difference is only displayed for large volumes of water.

10.4 Cleaning

Clean plastic parts with a soft, damp cloth only; do not use solvents, detergents, or acidic cleaning agents.

11 Maintenance

It is recommended and to assist in the longevity of your Infinity unit, that regular maintenance occurs. This should always be undertaken by specialist staff who will also replace worn parts.

We advise you to conclude a maintenance contract. Maintenance must be performed once each year, and twice each year for municipal systems, by your local plumber/installer.

11.1 Troubleshooting

Fault	Cause	Action
Drop in water pressure	Dirty filter screen	Complete backwash and re-view frequency setting
Flushing water outlet does not close	Backwash element does not reach the end position due to large particles of dirt	Repeat backwash by turning power on and off
Display shows ERR	Pressure too low	<ol style="list-style-type: none"> 1. Check inlet pressure is more than 350 kPa 2. Backwash

If the fault cannot be rectified by following these tips, contact your local **Reece** branch.

12 Technical data

Infinity A		Model	DN20	DN25	DN32	DN40	DN50	
Connection size			3/4" BSP	1" BSP	1 1/4" BSP	1 1/2" BSP	2" BSP	
Filter screen	µm	90/110						
Nominal pressure	kPa	1600						
Operating pressure range	kPa	350-1600						
Operating temperature (water)	°C	5-30						
Operating temperature (ambient)	°C	5-40						
Power supply	V/Hz	240 / 50						
Unit operation power	V DC	24						
Power consumption during backwashing	W	8						
Connection Module	type	Push and turn			Four-hole flange			
Overall length without fittings	mm	100	100	105	140	140		
Overall length with fittings	mm	191	205	243	296	342		
Total height	A	mm	510					
Height	B	mm	315					
Height	C	mm	295					
Minimum distance pipe centre to floor	D	mm	670					
Hose connection (diameter)	mm	20						

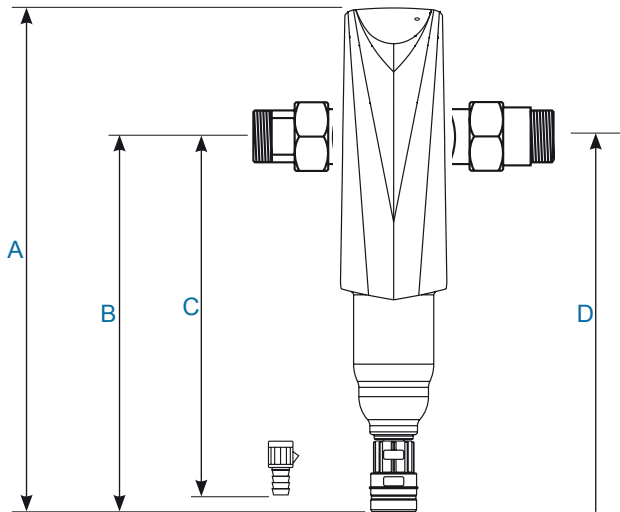

12.1 Pressure Drop/Flow Rate

DN 20

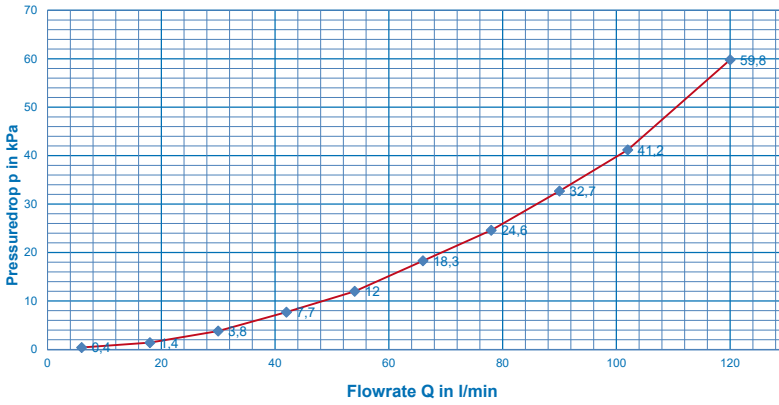

DN 25

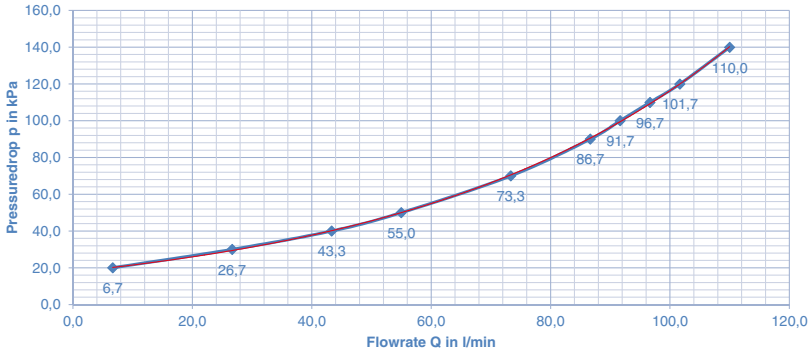

DN 32

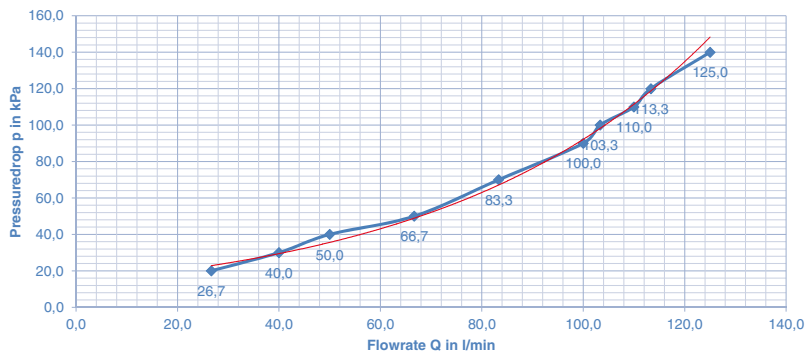

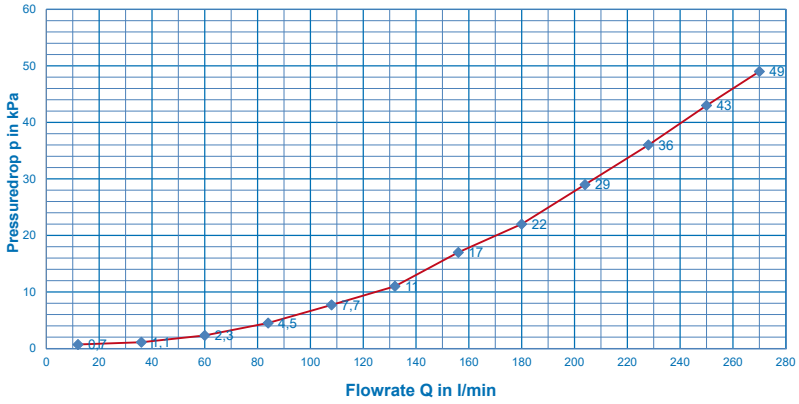

DN 40

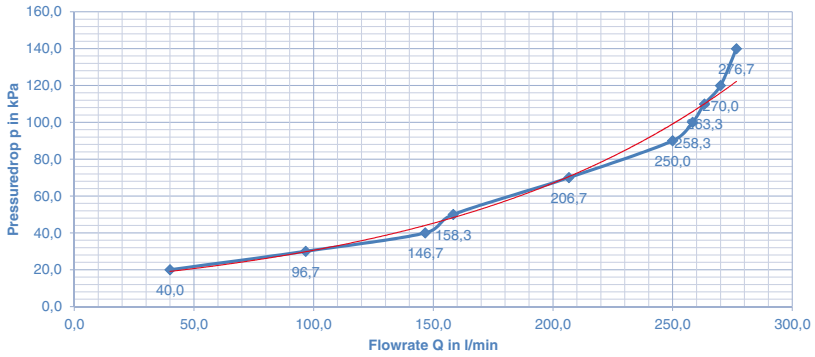

DN 50



 BWT <small>BEST WATER TECHNOLOGY</small>		
Infinity A 1		
Auto Backwash Filter Operating Specifications		
Type:	1 1/2"	2"
Nominal Size:	DN40	DN50
Flow rate (litres per min):		
Δp=20 kPa m ³ /h	10	10
Δp=50 kPa m ³ /h	16	16
Pressure Loss:		
@ 200 kPa:	2.5	2.5
@ 500 kPa:	4.5	4.5
Nominal Pressure (kPa):	1600	1600
Recommended Operating Pressure Range (kPa):	300-600	300-600
Filter Efficiency (Micron):	90-110	90-110
Operating Temperature (°C):		
Water	5-30	5-30
Ambient	5-40	5-40
Power Consumption During Backwashing (Watts):	8W	8W
Order Number	10628	2
S/N	*2)	3
		
<small>IMPORTANT NOTICE FOR THE CORRECT OPERATION AND MAINTENANCE OF THIS PRODUCT, IT IS ESSENTIAL TO OBSERVE THE MANUFACTURER'S INSTRUCTIONS.</small>		
<small>For further information please visit www.reece.com.au</small>		

12.2 Type label

The type label serves as product identifier. In case of any requests, please have the following information ready:

1. Device name
2. Order-no.
3. Serial number

Note: The type label is an official document and must not be altered or stripped off. Damaged or unreadable type labels have to be replaced.

13 Warranty

In the event of a malfunction during the warranty period, please contact our after-sales service department, stating the type of unit and the product number (PNR) (see the technical data or the type plate on the unit).

14 Decommissioning and disposal

14.1 Decommissioning

The product may only be shut down and dismantled by qualified specialists.

Observe all applicable safety regulations when dismantling the system.

14.2 Disposal

NOTICE



- ▶ At the end of the product's life cycle, ensure that it is properly disposed of or recycled.
- ▶ Observe the legal disposal guidelines for the country in which the product is used.
- ▶ The following materials are used in the product: metal, plastic

Further information:

Reece. Works for you.™

Call **1800 032 566** or visit
www.reece.com.au for your
nearest Reece store.

Due to limitations in the printing process
the colours in this brochure are a guide
only.

The manufacturer/distributor reserves
the right to vary specifications or delete
models from their range without prior
notification. The manufacturer/distributor
takes no responsibility for printing errors.

www.reece.com.au

