

Smart Control Box



Installation and operating manual





CONTENTS

1. SAFETY	17
1.1 Identification of warnings	17
1.2 General points.....	17
2. TRANSPORT/DISPOSAL	17
2.1 Transport.....	17
2.2 Disposal.....	17
3. DESCRIPTION	17
3.1 Application.....	17
3.2 Technical data of the control box	17
3.3 Technical data of the detection device.....	17
3.4 Dimensions.....	17
4. INSTALLATION	17
4.1 Wall mounting.....	17
4.2 Connection of the float (Sanifos) and pump cables.....	17
4.2.1 Preparation of the conductive wires	17
4.2.2 Connectors wiring for pumps (Sanipump)	17
4.2.3 Connectors wiring for floats (Sanifos)	18
4.2.4 Using the terminal blocks	18
4.2.5 Connection to the Smart Control Box.....	19
4.3 Electrical connection.....	19
4.4 Connecting the wired external alarm box	19
4.5 Connection to the BMS	19
5. COMMISSIONING	20
5.1 Start-up configuration.....	20
5.2 Checks to be carried out for the commissioning of a Sanifos lifting station	20
6. OPERATION	20
6.1 Presentation of the front of the Box	20
6.1.1 Key identification	20
6.1.2 Operating lights.....	20
6.2 Using the control box	20
6.2.1 On screen display	20
6.2.2 Pump activation/deactivation	20
6.2.3 Navigating the menu.....	21
6.3 Presentation of the menus.....	21
6.3.1 Language Menu	21
6.3.2 Logs Menu.....	21
6.3.3 Settings Menu.....	22
6.4 Remote wired alarm box	23
6.4.1 Technical data.....	23
6.4.2 Dimensions.....	23
6.4.3 Installation	23
6.4.4 Operation.....	23
6.5 SFA connect (optional)	23
7. SHUTDOWN	23
8. MAINTENANCE	23
8.1 Resetting the pump log	23
8.2 Maintenance update.....	24
9. FAULT FINDING	24
10. FOR PROFESSIONALS	24
10.1 Return to the start-up screen	24
10.2 Explanation of the LEDs on the electronic board	24
10.3 Learning loops	24
11. GUARANTEE	24

1. SAFETY

1.1 IDENTIFICATION OF WARNINGS

	Meaning
DANGER	This term defines a high risk of danger, which can lead to death or serious injury, if not avoided.
WARNING	This term defines a medium risk of danger, which can lead to serious or minor injury, if not avoided.
NOTICE	This term characterises dangers to the machine and its proper operation.
	Warning of a general danger. The danger is specified by indications given in the table.
	This symbol characterises dangers associated with the voltage and provides information on voltage protection.

1.2 GENERAL POINTS

This operating and installation manual contains important instructions to follow for the fitting, operation and maintenance of the XXX control box. Following these instructions guarantees safe operation and prevents injury and property damage. It always has to be available on site of operation of the machine/plant.

Not only the general safety instructions mentioned in this main point on safety have to be observed, but also the special safety instructions mentioned in the other sections.

Failure to comply with this operating and installation manual will result in the loss of warranty rights and rights to damages.

2. TRANSPORT/DISPOSAL

2.1 TRANSPORT

For all transportation, the control panel must be switched off (see 7. Shutdown)

ENVIRONMENTAL TRANSPORT CONDITIONS:

Parameters	Value
Relative humidity	85% maxi. (no condensation)
Ambient temperature	-10°C to +70°C

2.2 DISPOSAL



The device must not be disposed of as household waste and must be disposed of at a recycling point for electrical equipment. The device's materials and components are reusable. The disposal of electrical and electronic waste, recycling and recovery of any form of used appliances contribute to the preservation of our environment.

3. DESCRIPTION

3.1 APPLICATION

The **Smart control box** is a monitoring and control box for SFA lifting stations. It allows the operation and parameterization of the connected station, as well as the real time consultation of the activity and operation history.

3.2 TECHNICAL DATA OF THE CONTROL BOX

Parameter	Value
Nominal supply voltage	1 - 220-240 V AC
Network frequency	50-60 Hz
Protection class	IP 54
Power cable	Type
	Length

3.3 TECHNICAL DATA OF THE DETECTION DEVICE

- Analog level sensor
- Signal 0-5 V
- Input voltage 0-12 V

3.4 DIMENSIONS

Sanicubic

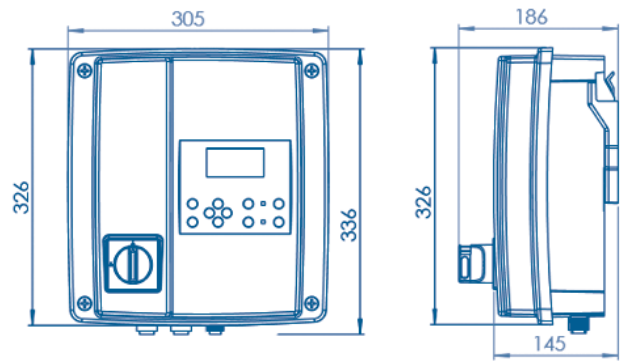

Sanifos

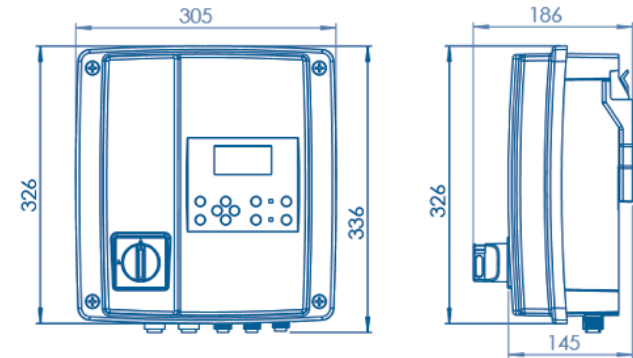

4. INSTALLATION

DANGER



Submersion of the control device.

Risk of electric shock!

⇒ Only use the control device in rooms safe from floods.

4.1 WALL MOUNTING

The **Smart controm box** must be installed indoors, in a place protected from humidity and frost.

The **Smart control box** is supplied with a wall bracket.

• Mount the wall bracket horizontally, using the appropriate fixings for your wall.

• Snap the **Smart control box** onto the bracket.

4.2 CONNECTION OF THE FLOAT (SANIFOS) AND PUMP CABLES

Cables are connected via waterproof terminal blocks.

4.2.1 Preparation of the conductive wires

	Connector	
Conductor	PE 	1-: N, L 3-: L1, L2, L3
Disassembly length y (mm)	33	25
Stripping length x (mm)	8	8

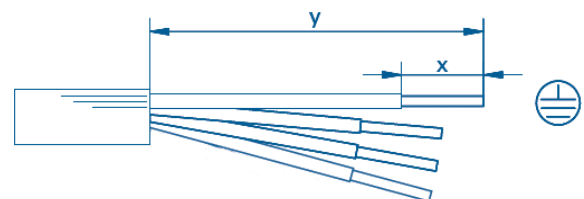

4.2.2 Connectors wiring for pumps (Sanipump)

NOTICE



⇒ It is imperative to respect the colours of the wires when making the connections so as not to cause a malfunction.

Sanifos with Sanipump GR/VX Single-phase version:

⏏: Green/Yellow wire
Position 1: Brown wire
Position 2: Blue wire
Position 3: White wire

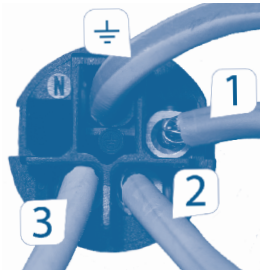

Sanifos with Sanipump GR/VX Three-phase version:

⏏: Green/Yellow wire
Position 1: Brown wire
Position 2: Black wire
Position 3: Grey wire

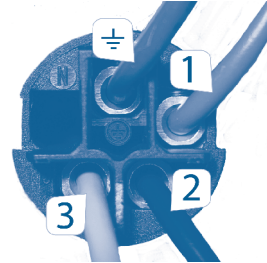

Sanifos with Sanipump SLD (single- or three-phase version):

⏏: Green/Yellow wire
Position 1: Black wire
Position 2: Grey wire
Position 3: Brown wire

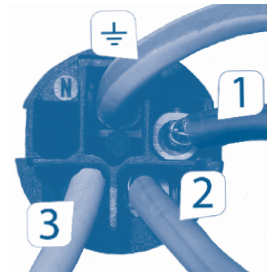

Note: The terminal blocks are already mounted on the Sanicubic pump cables.

4.2.3 Connectors wiring for floats (Sanifos)

Follow this wiring diagram:

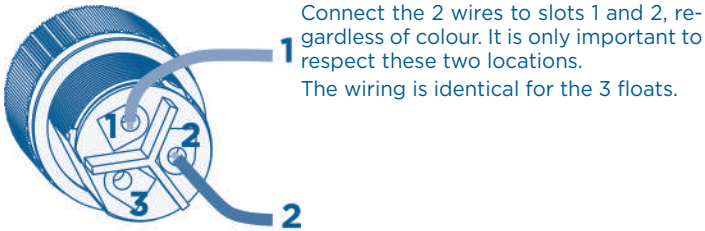

4.2.4 Using the terminal blocks

4.2.4.1 Assembling the connector

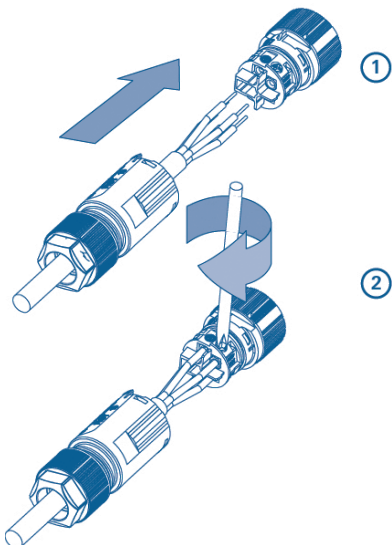

Tightening torque: 0,5 Nm
 (DIN 5264 A)

4.2.4.2 Closing the connector

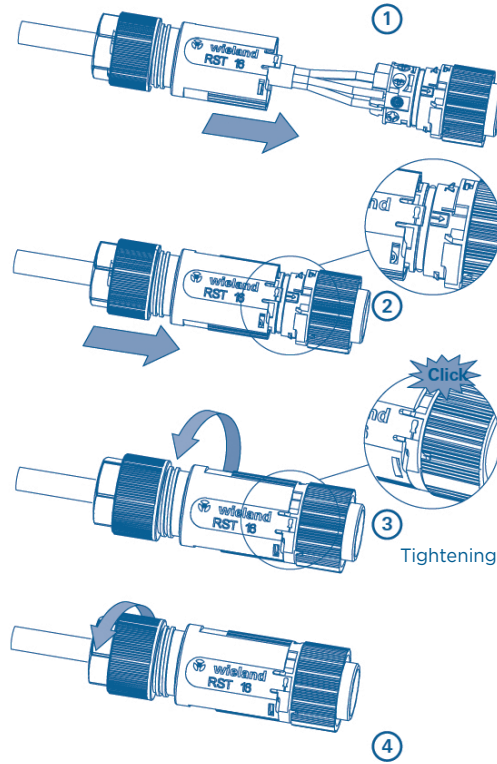

4.2.4.3 Opening the connector

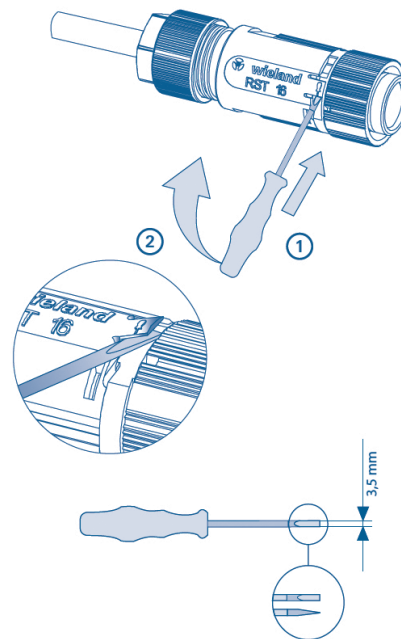

4.2.5 Connection to the Smart Control Box
4.2.5.1 Connecting and locking the connector

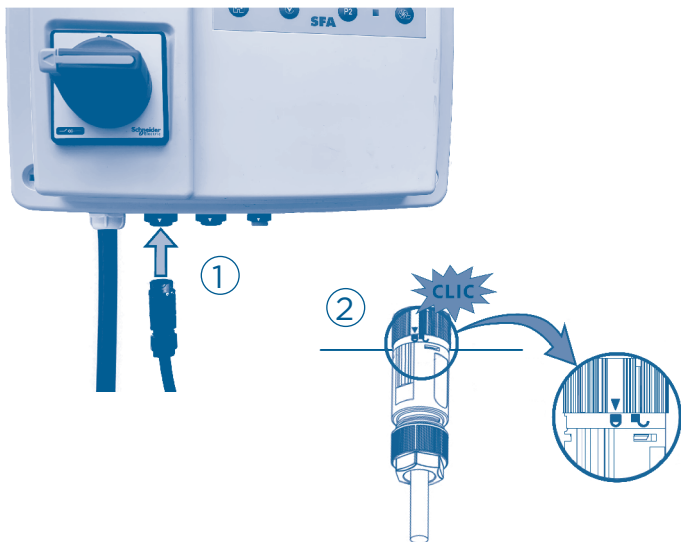

4.2.5.2 Unlocking and disconnecting the connector

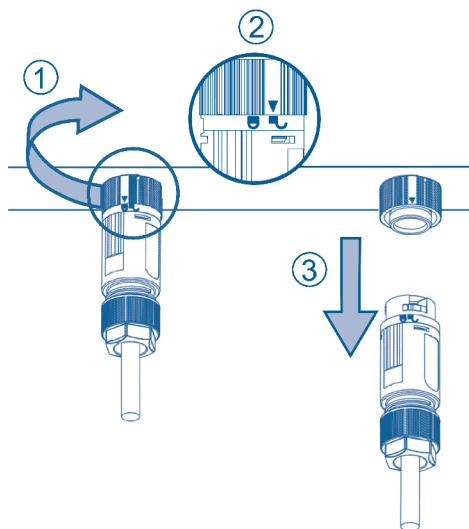

4.2.5.3 Location of Connector Connections

Sanifos

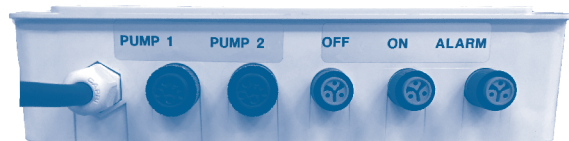

- Pump 1:** Pump 1
- Pump 2:** Pump 2
- OFF:** Low level float
- ON:** High level float
- ALARM:** Alarm float

Sanicubic



- Pump 1:** Pump 1
- Pump 2:** Pump 2
- PRESSOSTAT:** ON/Alarm level

NOTICE



Pulling force on the cables.

- Risk of tearing.
- ⇒ Cut the cables to the correct length.
- ⇒ Strip cables and wires.
- ⇒ Never pull or move the cables when they are connected.
- ⇒ Do not exert any constraints, e.g. by bending the cable too tightly.

4.3 ELECTRICAL CONNECTION

DANGER



Electrical connection work performed by an unqualified personnel.

- Risk of electric shock!
- ⇒ The electrical connection must be carried out by a qualified electrician.
- ⇒ The electrical connection must comply with the standards in force in the country of installation.

The device's power supply must be connected to ground (class I) and protected by a high sensitivity differential circuit breaker (30 mA) rated at:

- 25 A for single-phase **Sanicubic 2 VX**, **Sanifos** with 2 single-phase **Sanipump SLD**,
- 16 A for all other cases.

The connection must be used exclusively to provide the power to the **Smart Control Box**.

4.4 CONNECTING THE WIRED EXTERNAL ALARM BOX

The cable from the external alarm box is already connected to the electronic board.

- Connect the jack to the bottom of the external alarm box.
- Note: The power supply of the external alarm box is done through the **Smart box**. If the jack plug is incorrectly inserted, the external alarm box will signal a power failure (see 6.4.4 *Operation*).

4.5 CONNECTION TO THE BMS

Option of a remote alarm facility : dry contact (**no voltage**).
3 BMS are available: a BMS with NO (Normally Opened) contact, a BMS with NC (Normally Closed) contact and a configurable NO BMS (see 6.3.3 *Settings Menu*).

This contact opens (Normally Closed contact)/closes (Normally Opened contact) as soon as the station is in alarm mode and remains opened/closed as long as the default has not been corrected.

The terminals can be connected to a BMS (Building Management System) system or to a live system (max. AC 250V/16A, DC 250V/17A).

- Use one of the pre-holes on the side of the enclosure.
- Open the hole by tapping firmly with a screwdriver.
- Connect the connection cable directly to the circuit board using the illustrations below:

Location of BMS

Single-phase version:

Three-phase version:

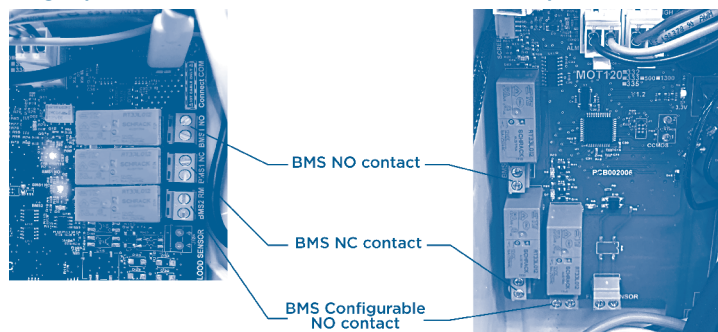

Wiring diagrams

Single-phase version:

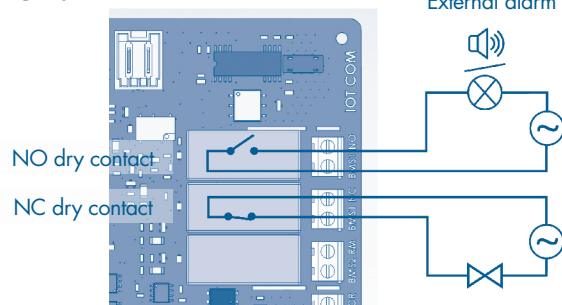

Three-phase version:
External alarm

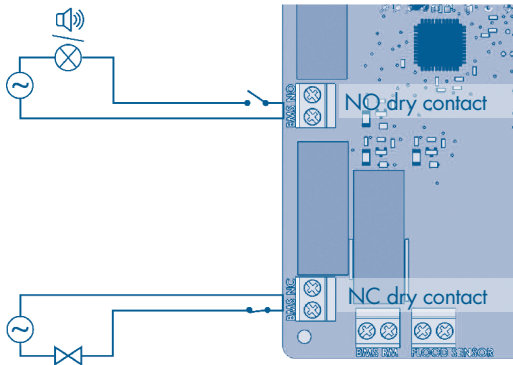

5. COMMISSIONING

5.1 START-UP CONFIGURATION

At the first start-up, it may be necessary to configure the box by selecting the connected station using the and keys:

- the installation tank: [Sani]Cubic 1, [Sani]Cubic 2, [Sani]Fos 500, [Sani]Fos 610 or [Sani]Fos 1300,
- the type of pump: Brushless, Grinder, Vortex or Solida.

Note: In case of an error or a change in the installation, it is possible to access this menu (see 10.1 Return to the start-up screen)

The operating parameters must then be selected: date, time, language and brightness of the display.

Note: The date and time must be set correctly for alarm management, alarm history and maintenance frequencies.

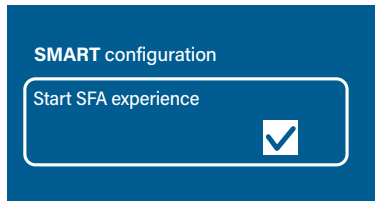

For each configuration screen, validate the selected setting by pressing the validation button. On the last screen (see opposite), press the confirmation button one last time to start the Smart box operation.

5.2 CHECKS TO BE CARRIED OUT FOR THE COMMISSIONING OF A SANIFOS LIFTING STATION

- Set the language, date and time.
- Define the use of the station: Individual, Collective or Commercial.
- Check that the quick connectors are correctly connected to the **Smart** unit.
- Check that the led on both pumps are green.
- Check the power supply voltage on the display.
- Fill the tank with water via the connected sanitary appliances.
- Check that the pumps switch on automatically at the set water level.
- Check that the water operating intensity of the pumps, shown on the display, is between
 - 4 and 7 A with **Sanipump GR**, **Sanipump VX** (single-phase and three-phase), **Sanicubic 1**, **Sanicubic 2**, **Sanicubic 2 VX** three-phase,
 - 6 and 12 A with **Sanicubic 1 VX** single-phase, **Sanicubic 2 VX** single-phase,
 - 7 and 10 A with **Sanipump SLD** single-phase,
 - 3 and 5 A with **Sanipump SLD** three-phase.
- Check the correct operation of the motors in forced operation.
- Check that the wired alarm box is switched on.
- Check the level of water in the tank at the end of the cycle:
 - **Sanicubic**: the water level must be below the longest dip tube.
 - **Sanifos** with **Sanipump VX** or **Sanipump SLD**: the water level must be above the pump cover plate.
 - **Sanifos** with **Sanipump GR**: the water level is +/- 10 cm from the bottom of the tank.
- Set the delay time accordingly.
- Set the delay for the start of the auxiliary pump. Measure the duration of an ON-OFF cycle and enter a value equal to at least 2 times the ON-OFF cycle value.
- Check that the data has been correctly recorded by the **Smart** box (log, pumping time...).

6. OPERATION

6.1 PRESENTATION OF THE FRONT OF THE BOX

6.1.1 Key identification



- ① Current switch
- ② Enter Key
- ③ Back
- ④ Navigation
- ⑤ Activation/deactivation of the pumps
- ⑥ Pump operation indicator light
- ⑦ Forced operation of pumps

6.1.2 Operating lights

The light is green when the pump is activated.
The light is red when the pump is deactivated (by a manual lockout or automatically following a fault).

6.2 USING THE CONTROL BOX

6.2.1 On screen display

6.2.1.1 Normal operation

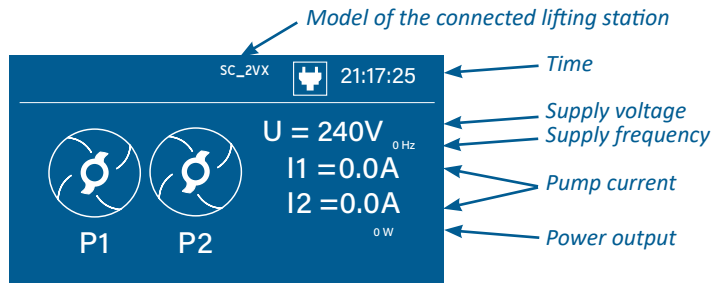

Operation of the pumps:
on (impeller turns) or off (impeller is fixed)

6.2.1.2 Alarm display

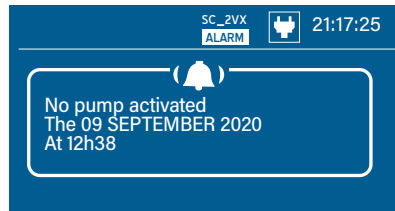

Alarm indicator in real time, with identification of the problem detected for quick maintenance.

A special window giving the alarm type and the alarm time remains open for some time.

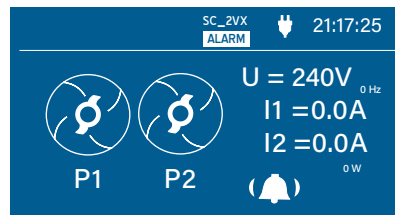

As soon as the fault disappears, return to the general screen on which an alarm notification appears. To remove the alarm notification, simply press one of the two forced-on buttons. Details of the alarms can be consulted in the alarm log.

6.2.2 Pump activation/deactivation

In the case of maintenance or replacement of a pump, it is possible to deactivate each pump independently.

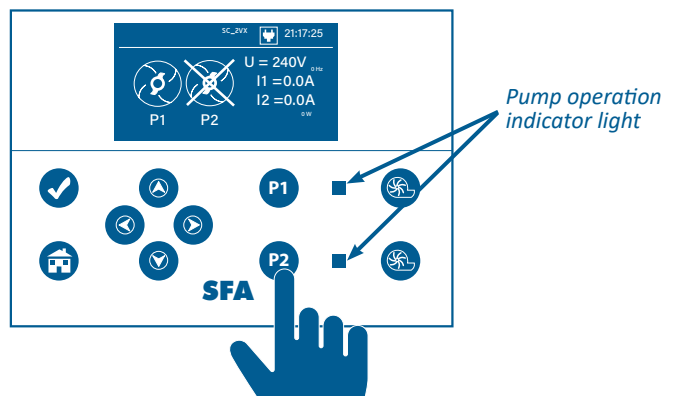

To deactivate the pump: Press continuously for 5 seconds on the selected pump. The led turns red and a cross is displayed on the shut-down pump.

To reactivate the pump: Press again continuously for 5 seconds. The led turns green and the cross turns off.

6.2.3 Navigating the menu

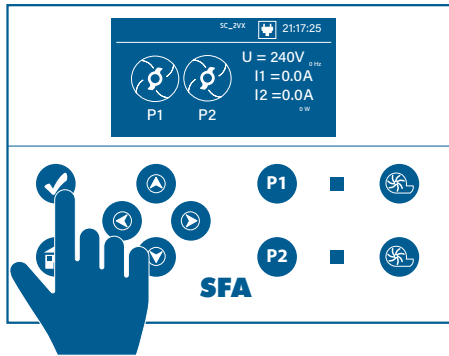

Pressing the “Enter” key takes you to the main menu:



Navigation through the menus and submenus is done using the arrow keys, Enter and Back:

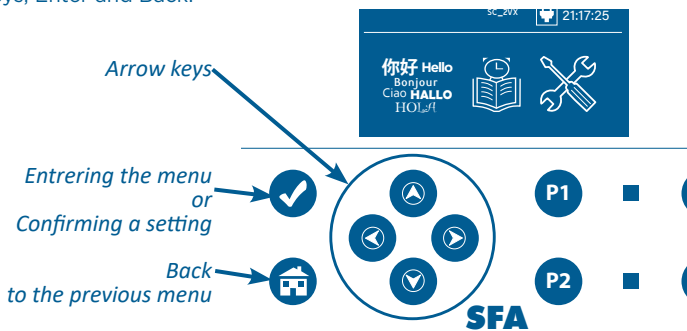

6.3 PRESENTATION OF THE MENUS

6.3.1 Language Menu



Enter the “Languages” menu by pressing the “Enter” key.

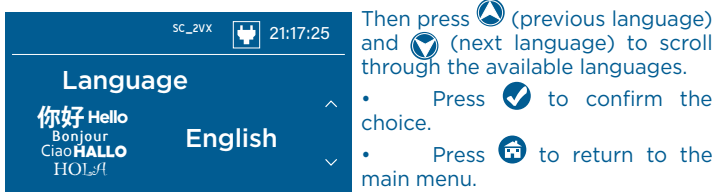

Then press (previous language) and (next language) to scroll through the available languages.

- Press (checkmark) to confirm the choice.
- Press (home) to return to the main menu.

6.3.2 Logs Menu

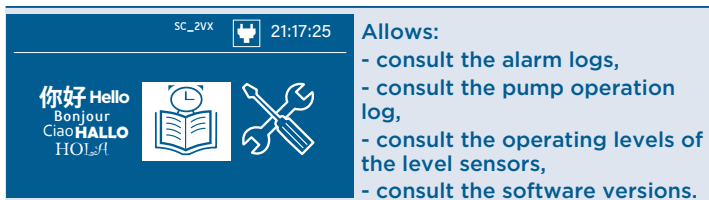

- Enter the “Logs” menu by pressing the “Enter” key.

- Then press (up) and (down) to scroll through the submenus. Confirm with (checkmark) to enter the submenu.

6.3.2.1 Alarm logs

Possibility to consult the history of the last 32 alarms.

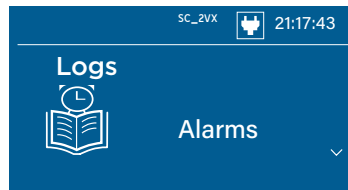

Indication of the type of alarm

Date of last alarm

Time of last alarm



- Then press (previous alarm) and (next alarm) to scroll through the alarm messages.

- Press (home) to return to the main menu.

No modifications are possible.

The oldest alarms are automatically deleted when the number of searchable alarms is exceeded.

6.3.2.2 Pumps operation

Allows you to view the operating information of the pumps.

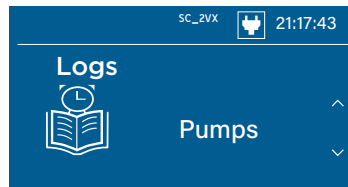

	P1	P2
START-UP:	593	720
T_MAX:	292s	75s
TOTAL:	1h29m23	1h27m30

P1: Pump 1
P2: Pump 2

START-UP: total number of starts for each pump

T_MAX: maximum running time for each pump (maximum duration of an ON-OFF cycle)

TOTAL: total running time of each pump since its first use.

- Press (home) to return to the main menu.

No modifications are possible.

The resetting of the pump counter is reserved for professionals (see 8.1 Resetting the pump log)

6.3.2.3 Sensors operation

Allows to consult the activation height of the level sensors ON, OFF (for Sanifos) and ALARM.

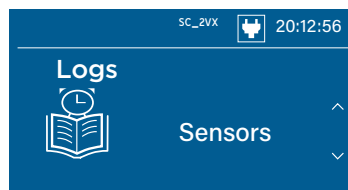

Sanifos

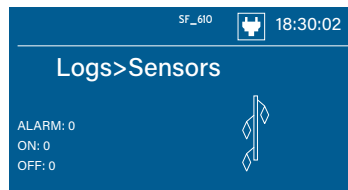

ALARM: Switch-on level in case of alarm; simultaneous operation of both pumps.
ON: Standard switch-on level. Standard operation with one pump at a time. Alternating pump at each cycle.
OFF: Pump switch-off level.

Sanicubic

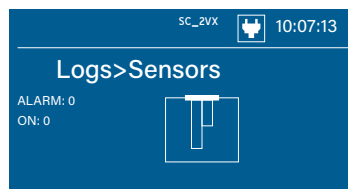

ALARM: Switch-on level in case of alarm; simultaneous operation of both pumps.
ON: Standard switch-on level. Standard operation with one pump at a time. Alternating pump at each cycle.

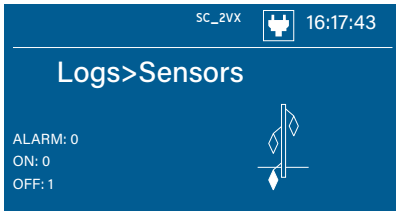

A sensor being activated:
- is white on the display
- has a value of 1.

6.3.2.4 Consulting software versions and configuration

Allows you to consult:

- the tank-pump combination (Model) selected for the installation,
- the software versions for the control box's motherboard and the screen card. This may be necessary in case of maintenance or intervention on the enclosure.

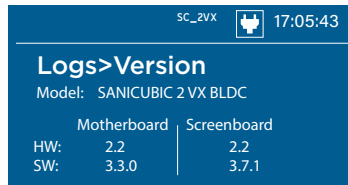
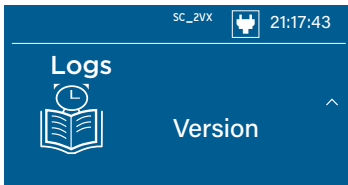

MODEL: the model of the station connected to the box as set at the time of commissioning. If it does not match, see 10.1 Return to the start-up screen to change the model.

- **HW:** the hardware version for the motherboard and the display board.
- **SW:** the software version for the motherboard and for the display board.

- Press to return to the main menu.

This information cannot be changed.

6.3.3 Settings Menu

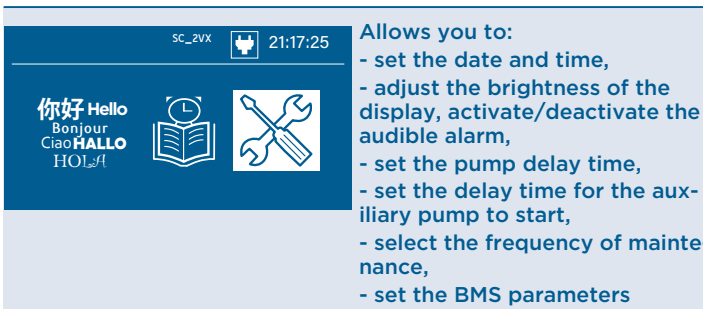

Allows you to:

- set the date and time,
- adjust the brightness of the display, activate/deactivate the audible alarm,
- set the pump delay time,
- set the delay time for the auxiliary pump to start,
- select the frequency of maintenance,
- set the BMS parameters

6.3.3.1 Setting the date

The date setting is particularly important for alarm management and maintenance monitoring.

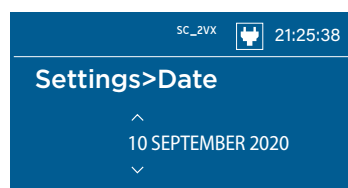
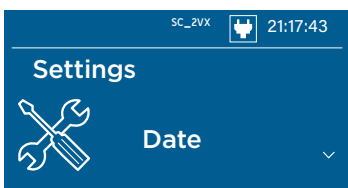

- Then press and to select the value.
- Then press and to switch from day to month and month to year.
- Press to confirm the choice.
- Press to return to the main menu.

6.3.3.2 Setting the hour

The hour setting is important for alarm management.

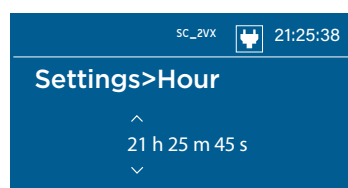
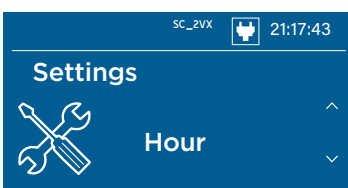

- Then press and to select the value.
- Then press and to switch from hour to minute and minute to second.
- Press to confirm the choice.

- Press to return to the main menu.

6.3.3.3 Various

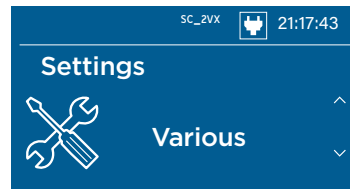

Then press and to scroll through the submenus. Confirm with to enter the submenu.

Brightness adjustment

Allows you to adjust the brightness of the display during use.

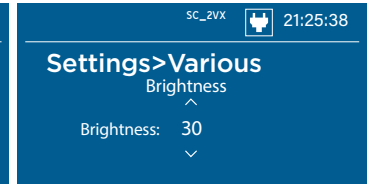

- Press and to select the value.
- Press to confirm the choice.
- Press to return to the main menu.

Enable/disable audible alarm

Selects whether the alarm notification (display of an alarm window) is accompanied by an audible signal.

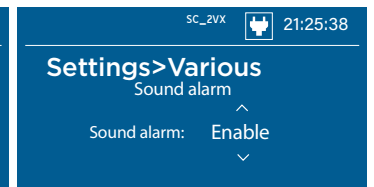

- Press and to choose between «Enable» or «Disable».
- Press to confirm the choice.
- Press to return to the main menu.

6.3.3.4 Setting the Stop delay time

The stop delay time is an additional pumping time when the pump's stop level has been reached. It allows the tank to be emptied as much as possible and optimises the pumping of surface matter.

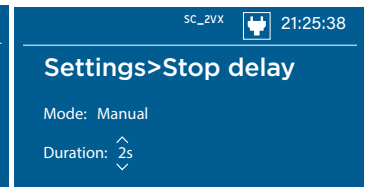
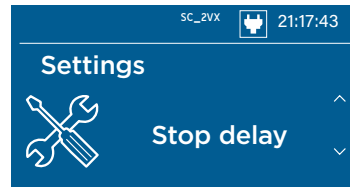

- **Mode:** This pump stop delay can be managed manually («Manual») or automatically («Automatic») depending on the station configured at commissioning and the duration of the last pumping times (for more details see 10.3 Learning loops).
- **Duration:** In Manual mode, you can enter a time delay value between 0 and 120 seconds, in increments of 1 s.

- Press and to choose between «Manual» and «Automatic».
- Press and to switch from Mode to Duration.
- Press and to choose the duration.
- Press to confirm the choice.
- Press to return to the main menu.

Note:

- If the automatic management mode has been chosen, the "Duration" parameter cannot be modified.

- If Sanipump SLD was selected, the value is 0 s and cannot be changed.

6.3.3.5 Setting the start of the auxiliary pump

When one of the pumps is running continuously, the second pump is activated after the time set in this menu to support the first pump. This activation of the auxiliary pump corresponds to an abnormal case (e.g. a hydraulic problem on the 1st pump) and will cause the automatic deactivation of the 1st pump.

To be relevant, the set time must be at least twice the duration of a normal ON-OFF cycle.

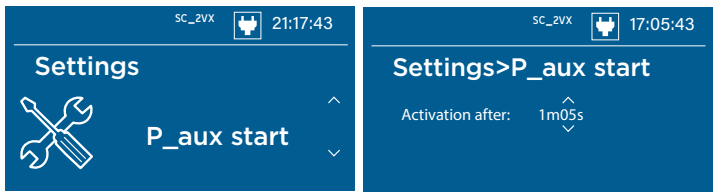

ACTIVATION AFTER: The delay for starting the auxiliary pump is adjustable and must be between 15 s and 5 min (5 s increments).

- Then press and to select the value.
- Press to confirm the choice.
- Press to return to the main menu.

6.3.3.6 Setting the maintenance frequency

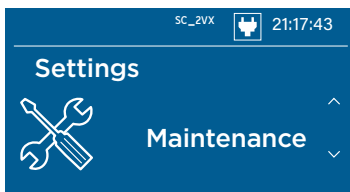

Indicates when the next maintenance is due. A reminder on the display will appear on the scheduled date.

The maintenance frequencies are different depending on the area of use of the station (according to EN12056-4):

- collective: 3 months;
- commercial: 6 months;
- individual: 12 months.

Changing the type of use:



Important: Validating a use type for the installation resets the maintenance counter to 0.

- Then press (previous use) and (next use) to select the intensity of use for the station.
- Press to confirm the choice.
- Press to return to the main menu.

6.3.3.7 BMS

The BMS (Building Management System) menu allows setting the conditions for the configurable BMS NO (Normally Open). It is possible to set a voltage or current condition for its operation. By default, the BMS is set to "Disable".

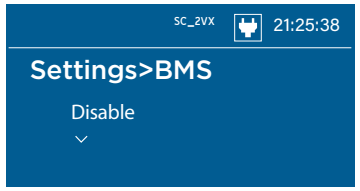
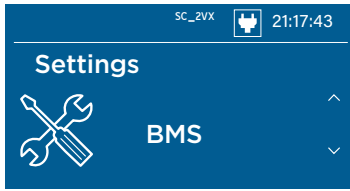

- Press to switch from «Disable» to «Enable»
- Press to confirm the choice.

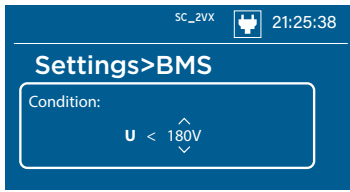

The possible modifications concern:

- the PARAMETER that defines the condition: U (voltage) or I (current),
- the CONDITION < (below) or > (above),
- the value: from 150 to 450 V (in increments of 10 V) or from 1 to 25 A (in increments of 1 A).
- Press and to change the setting.
- Press and to switch from Parameter to Condition then from Condition to the value.
- Press to confirm the choice.
- Press to return to the main menu.

6.4 REMOTE WIRED ALARM BOX

6.4.1 Technical data

Audio and visual information

5 m cable length
Protection index: IP44

6.4.2 Dimensions

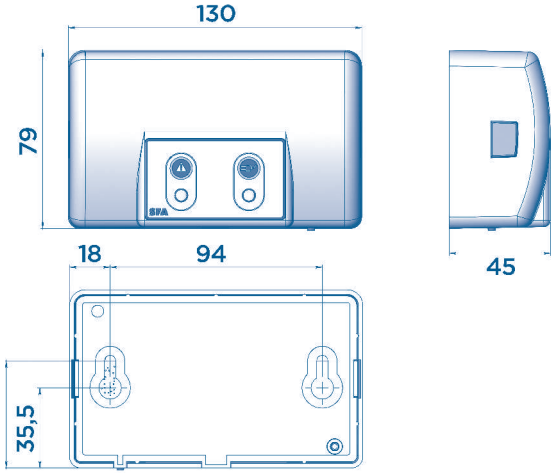

6.4.3 Installation

- The alarm box must be installed indoors, in a damp-free location.
 - The alarm signal must always be visible to the user.
- Note: It does not require an independent power supply. The power supply is provided by the **Smart** box. In the event of a power cut, the battery of the alarm box takes over.

6.4.4 Operation

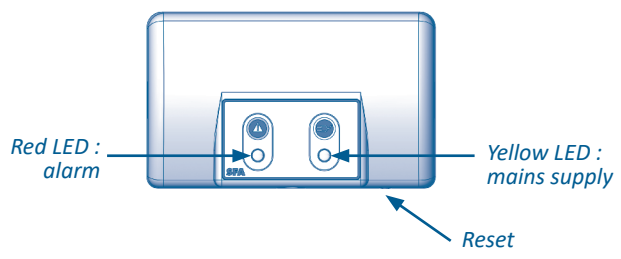

The red general alarm LED indicates that there is an alarm in the **Smart Control Box**. The alarm unit sounds as long as the fault is present. To stop the alarm, press the reset button under the alarm unit or solve the problem on the **Smart Control Box**.

The yellow «mains» LED indicates the power supply status of the alarm unit:

- light on steady = **Smart Control Box** on mains supply
- flashing and buzzer = power failure on the **Smart Control Box**. After 1 minute, the siren is discontinued.

The alarm box can be completely switched off by pressing and holding the reset button (*).

6.5 SFA CONNECT (OPTIONAL)

The SFA connect option allows, thanks to your WiFi box, to link your Smart box to a Smartphone application. It is then possible to remotely consult the operating information of your lifting station (power supply check, maintenance status...) and to be informed in real time of alerts by notification or email. Please refer to the manual delivered with **SFA Connect**.

7. SHUTDOWN

The **Smart control box** has a battery to keep the unit powered up in case of a power failure.

When switching off the Control Box, the power supply to the box must be switched off as well as this battery to allow the system to be powered down. 2 possibilities exist:

- During the 30 seconds following the powering up of the unit, switching the current switch to the OFF position allows a complete shutdown.
- Press the "Back", "P1" and "P2" keys simultaneously.

8. MAINTENANCE

8.1 RESETTING THE PUMP LOG

It may be necessary to reset a pump's operating counters to 0, e.g. if the pump is changed.

Press the "Enter" and "P1" (or "P2" depending on the pump) keys simultaneously.

The 3 parameters (number of starts, maximum pumping time and total running time) are then reset to 0 for the pump in question.

8.2 MAINTENANCE UPDATE

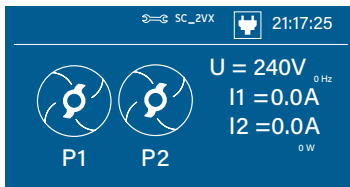

The icon  indicates that the maintenance of the installation has to be done.

Once the maintenance has been done, enter a new frequency setting (see 6.2.3 Navigating the menu): the new maintenance date is set and the icon disappears.

9. FAULT FINDING

Alarm message on the display	Possible cause	Remedy
No AC	No power supply.	Check power supply. Turn the current switch into position ON (I)
Pump P1 switched OFF	Pump 1 deactivated (activation lamp lights up red).	Reactivate the pump by pressing the activation button. In case of automatic deactivation, check the alarm log to verify the cause of the problem.
Pump P2 switched OFF	Pump 2 deactivated (activation lamp lights up red).	Reactivate the pump by pressing the activation button. In case of automatic deactivation, check the alarm log to verify the cause of the problem.
No pump activated	Pumps deactivated (activation lamps light up red).	Reactivate the pumps by pressing the activation buttons. In case of automatic deactivation, check the alarm log to verify the cause of the problem.
Levels sensors fault	Clogged sensor	Clean the sensor, unclog the compression chambers. Remove deposits in the tank.
	Blocked sensor	Check that the floats move freely. Remove deposits in the tank.
	Incorrect wiring of the sensors.	Check the wiring of the sensor terminals.
	Incorrect connection of the sensors.	Check the correct location of the float connection on the casing.
	Incorrect position of the floats on the rail.	Check the position of the floats.
	Float defective.	Contact after-sales service.
P1 I=0 Amp P2 I=0 Amp	Pump disconnected.	Check pump connection. Check the wiring of the pump terminals.
	Thermal break.	Pump connection occurs automatically after a delay. Thermal break is a symptom of a malfunction that requires a thorough check.
	Defective pump.	Check the pump.
P1 hydraulic issue P2 hydraulic issue	Problem pump cover plate. Impeller problem.	Check pump hydraulics.
	Clogged pipe.	Check the discharge pipe.
	Shut-off valve closed	Open the shut-off valve
P1 I>Imax P2 I>Imax	Blockage of the pump.	Check for foreign bodies
	Motor failure	Contact after-sales service.
Evacuation issue	Unable to evacuate water from the station.	Check for clogged discharge pipe. Check that the shut-off valve is open. Check that both pumps are working properly.

10. FOR PROFESSIONALS

10.1 RETURN TO THE START-UP SCREEN

You can return to the settings made when the device was commissioned by pressing the 4 arrow keys , , , and .

In particular, the choice of the connected station can be changed.

10.2 EXPLANATION OF THE LEDs ON THE ELECTRONIC BOARD

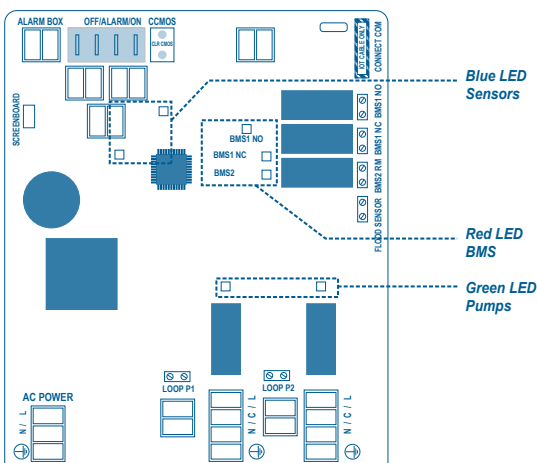

Note: The photograph below is used as an example. Indeed, the location of the LEDs may vary but the colours and their indications are identical to all electronic boards.

Blue LED: level indication

LED on = level sensor activated

Red LED: BMS operation

- LED on = event defined by the BMS condition is in progress

- LED off = no BMS event in progress

Green LED: pump operation

- LED on = pump running

- LED off = pump off

NOTICE



⇒ If the enclosure has been opened, take care not to pinch or pull the cable when refitting the front panel.

10.3 LEARNING LOOPS

The management of the delay time in "Automatic" mode is not adjustable. It is calculated using a learning loop that averages the last 5 switch-ons.

An increasing delay time is the symptom of a drop in output flow and may therefore indicate a fault in the discharge installation (clogging, etc.).

11. GUARANTEE

Smart Control Box is guaranteed for 2 years for parts and labour, subject to correct installation, use and maintenance of the unit.

Sanicubic 3- (400 V)

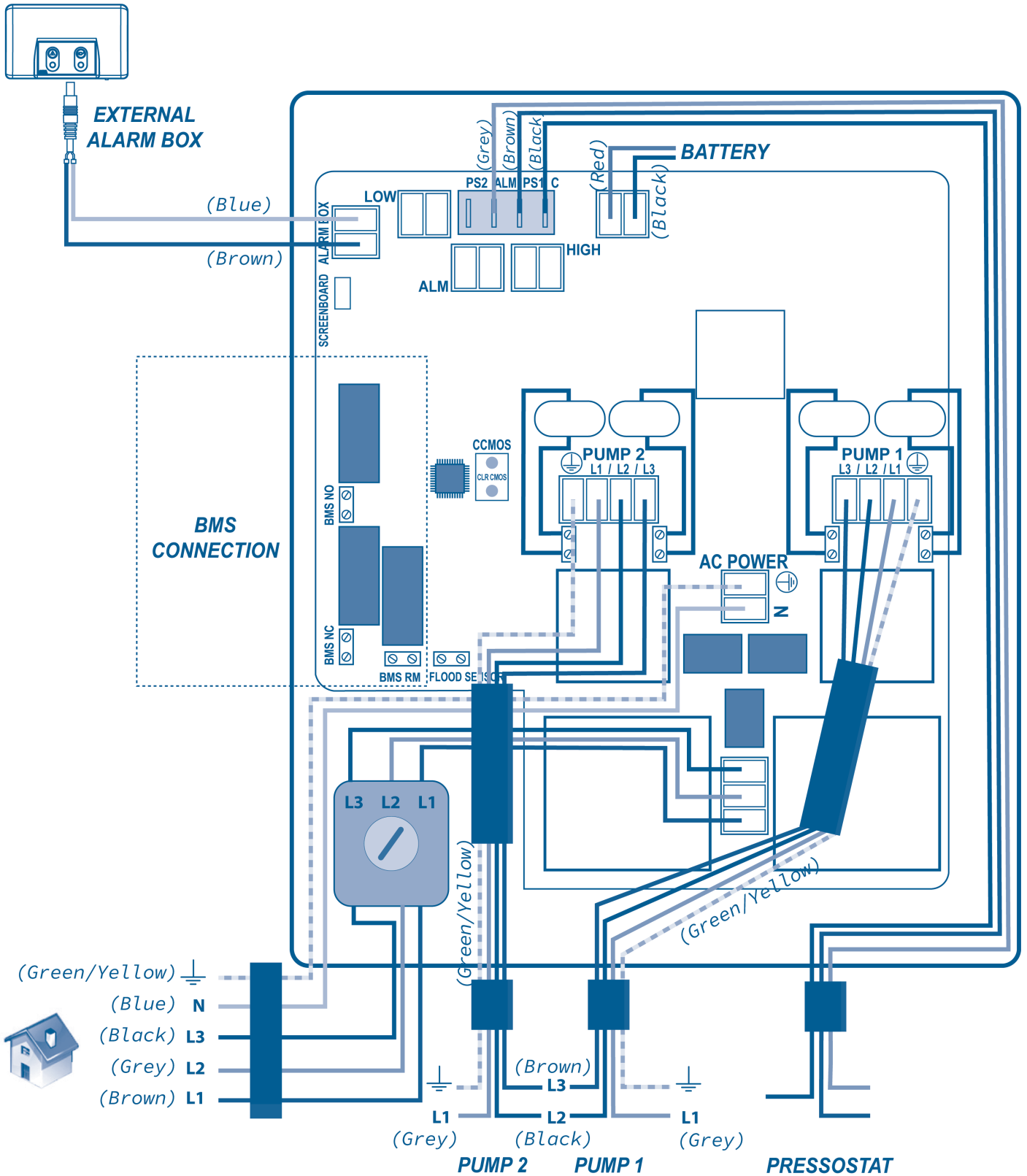

Sanifos 3~ (400 V)

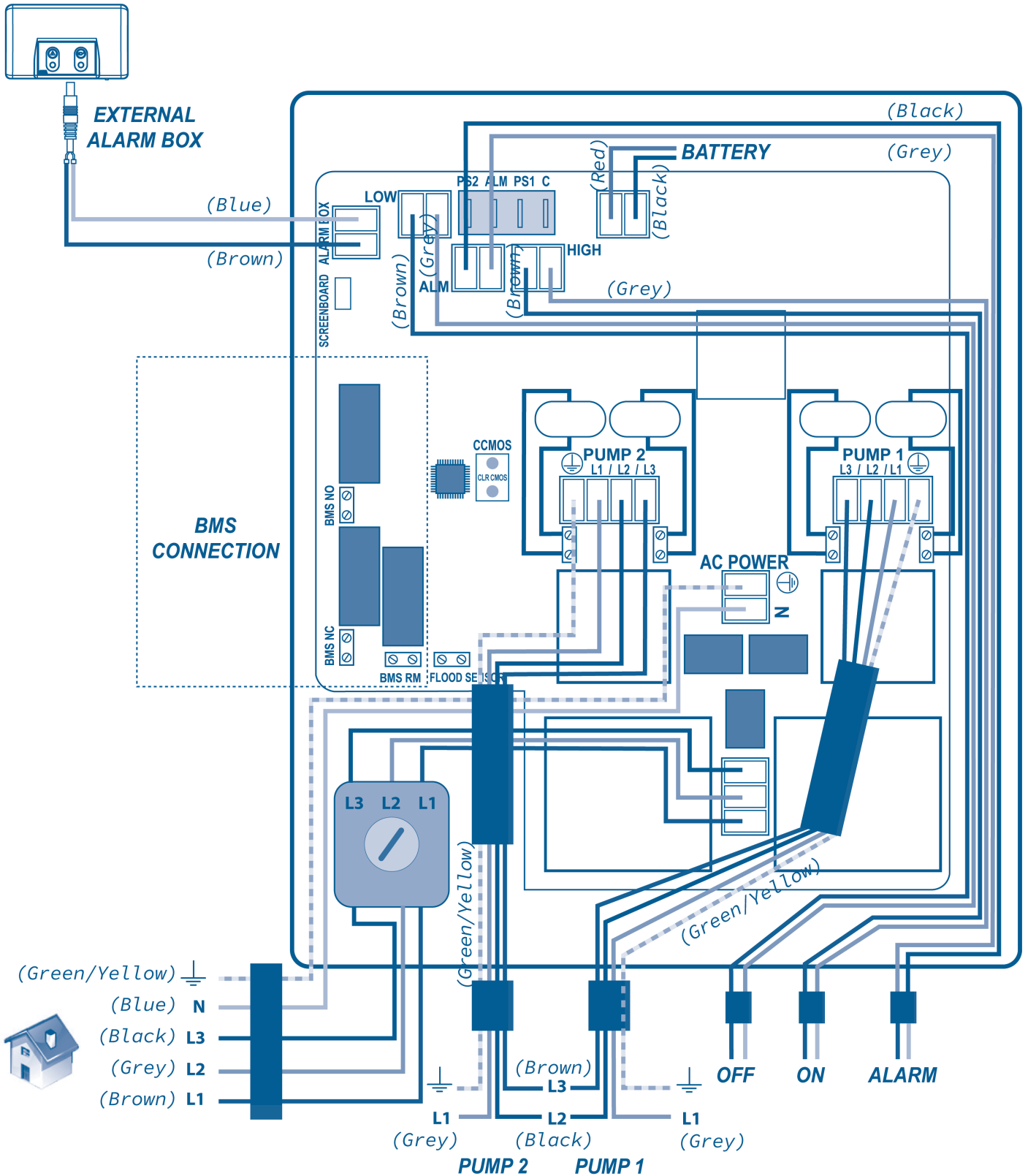

- Brown, Marron, Braun, Marrón, Marrone, Castanho, Bruin, Hnědá, Brun, Ruskea, Brązowy, Maro, Коричневый, Brun, 棕色
- Red, Rouge, Rot, Rojo, Rosso, Vermelho, Rood, Červená, Rød, Punainen, Czerwony, Roşu, Красный, Röd, 红色
- Green/Yellow, Vert/Jaune, Grün/Gelb, Verde/Amarillo, Verde/Giallo, Verde/Amarelo, Groen/Geel, Zelená/Žlutá, Grøn/Gul, Vihreä/Keltainen, Zielona/Żółty, Verde/Galben, Зеленый/Желтый, Grön/Gul, 绿色/黄色
- Blue, Bleu, Blau, Azul, Blu, Azul, Blauw, Modrá, Blå, Sininen, Niebieski, Albastru, Голубой, Blå, 蓝色
- White, Blanc, Weiß, Blanco, Bianco, Branco, Wit, Bílá, Hvid, Valkoinen, Biała, Alb, Белый, Vit, 白
- Black, Noir, Schwarz, Negro, Nero, Preto, Zwart, Černá, Sort, Musta, Czarny, Negru, Черный, Svart, 黑色

AUSTRALIA

**SFA Saniflo Australia Pty
Ltd** Unit 9-10, 25 Gibbes
Street Chatswood
NSW 2067
Tel. +61 298 826 200

NEW ZEALAND

SFA Saniflo New Zealand Ltd
PO Box 383 Royal Oak,
Auckland 1345
Tel : 09 390 4615

SERVICE HELPLINES

Australia

Tel. +1300 554 779

New Zealand

Tel. 0800 107 264