

# henden™

---

## Elevate Inverter Heat Pump

# Installation & Owners Manual

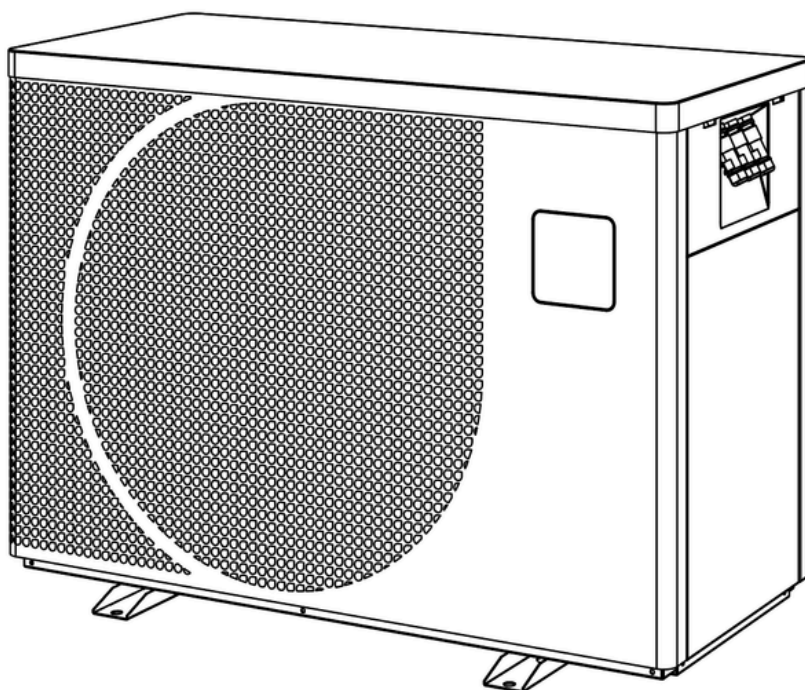

**IMPORTANT**  
Please read carefully



### CAUTIONS AND WARNINGS



**WARNING: Electrical installation must be carried out by a licenced electrician in accordance with the wiring rules and local regulations.**

Keep the Henden Inverter Heat Pump away from any potential fire source.

The Henden Inverter Heat Pump must be placed in a well ventilated area.

Repair must be carried out by manufacturer approved service personnel.

Date Issued: November 2024

# Table of contents

1. Specifications
2. Dimensions
3. General information
4. Installation and connection
5. Operation
6. Wi-Fi/App connectivity
7. Troubleshooting
8. Appendix
9. Warranty

## WARNINGS

1. Key operating information for users.

### **Important information for user**

This document contains important information about the safe use and efficient operation of your Henden Elevate heat pump pool heater. Please read the information carefully before operating the heater.

The information related to install and maintenance of the heat pump is intended primarily for installers, but users may find the information useful. Installation and maintenance of the heat pump must be carried out by a qualified person.

This heat pump requires mains electricity to operate. The mains electricity must be supplied through a weatherproof electrical isolation switch, installed adjacent to the heat pump, in accordance with the Wiring Rules.

Additionally, this heat pump requires water flowing through its heat exchanger to operate. A water pump that is providing water flow to the heat pump may be controlled manually, by the heat pump or by an external controller, depending on how your pool system was installed.

This heat pump requires continuous supply of fresh air to operate effectively. Ensure the clearance requirement stated in this manual is maintained at all times and any obstruction which may impede air ventilation is removed around the heat pump. Limited air movement may result in poor energy efficiency and may reduce the life of the refrigerating system components, and resulting failures may not be covered under warranty.

The energy efficiency and the heating/cooling capacity of your heat pump depends on the ambient temperature and humidity of the installed location. Representative figures for each Henden Elevate heat pump model are listed in this manual for selected ambient temperature and humidity conditions.

Thermal cover should be applied over the pool to minimise heat loss and improve the energy efficiency of the pool heating system.

Water chemistry of your pool must be maintained in accordance with this instructions. Chlorinators, dosing systems, and any manual water treatment must occur downstream of the heat pump. Heat pump failure due to incorrect water chemistry and inappropriate water treatment practice may not be covered under warranty.

Your water pump system and water filtration system must be maintained periodically for the optimum operation of the Henden Elevate heat pump. Lack of maintenance in the water circulating system may result in greater energy consumption due to lowered water flow rate through the heat pump which may reduce the energy efficiency of the heat pump. Refer manufacturer's instructions for water pump and filtration maintenance procedures.

If your heat pump has difficulty connecting or maintaining stable connection with your home Wi-Fi, the signal strength may be too weak at the location where your heat pump is installed. Consider adding Wi-Fi signal extenders nearby.

This heat pump contains R32 refrigerant which is classified as a flammable gas under the Australian Dangerous Goods Code. Care must be taken to ensure any source of fire is kept away from the heat pump at all times. The refrigerant must not be released to the atmosphere.

This heat pump contains moving parts. Do not insert any object into the fan inlet protective cover.

Do not touch the evaporator fins located on the rear and side of the heat pump. Fins may be sharp and are fragile.

Do not modify or damage this heat pump in anyway. If the heat pump is damaged, contact your local Reece branch.

This heat pump is intended only for heating and cooling of pool water that is maintained to appropriate water chemistry. Application other than this may shorten the life of the heat pump and may not be covered under warranty. The heat pump must not be used for conditioning water for the purpose of personal hygiene or consumption.

This appliance is not intended for use by persons (including children) with reduced physical sensory or mental capabilities, or lack of experience and knowledge, unless they have been given supervision or instruction concerning use of the appliance by a person responsible for their safety.

Children should be supervised to ensure that they do not play with the appliance.

## 2. Key installation, safe operation and maintenance information for installers.

### **▲ WARNING**

Please read this manual carefully BEFORE installing, operating, and maintaining the Henden Elevate Heat Pump.

Installation must be carried out by a qualified pool professional and installed in accordance with this instructions, relevant Australian standards, local regulations and building codes.

Electrical installation must only be carried out by a licensed person.

Any work on refrigerating system must be carried out by a qualified person holding the appropriate refrigerant handling licence issued by the Australian Refrigeration Council (ARC).

Do not use means to accelerate the defrosting process or to clean, other than those recommended by the manufacturer.

The appliance shall be stored in a room without continuously operating ignition sources (for example: open flames, an operating gas appliance or an operating electric heater).

Do not pierce or burn.

Be aware that refrigerants many do not contain an odour.

For continued safety of this appliance, it must be installed, operated and maintained in accordance with the manufacturer's instructions.

## Installation

- This heat pump pool heater is a sealed system that is pre-charged with R32 refrigerant. Installation of this heat pump does not require refrigerant charging or work on refrigerant carrying components.
- This heat pump is suitable for outdoor installation only. It must not be located in a closed environment or indoors, and must be kept well ventilated. Do not place obstacles in front of the air inlet and outlet of the heat pump.
- Clearance around the heat pump must be maintained in accordance with this instructions.
- The heat pump should not be installed near living rooms, bedrooms and any other locations where the operational noise of the heat pump is of a concern to the occupants. Consideration must also be given to the neighbouring households.
- If the Wi-Fi functionality is to be used, the heat pump must be installed in a location where a solid home Wi-Fi signal strength is available. The Wi-Fi band must be in the 2.4 GHz range.
- This heat pump is heavy. Follow safe manual handling procedures and use mechanical aids where practicable for lifting.
- Do not lift the heat pump by the water connections as the titanium heat exchanger inside the heat pump may be damaged. Damage due to incorrect handling may not be covered under warranty.
- The heat pump must be removed from its packaging materials entirely, including pallet.
- The heat pump must be installed on a levelled hard surface that is able to withstand the weight of the unit. The heat pump should be installed on raised supports to enable access to the condensate drain for general maintenance and to reduce risk of corrosion due to dampness from rain. If the vibration of the heat pump is of a concern to the users, the supports should be vibration dampening type.
- Do not install the heat pump in a location that limits access to the display panel.
- Condensate drain elbow provided with the heat pump should be fitted on the dedicated thru hole located on the base of the unit. Connect the drain hose provided with the heat pump and locate the end of the hose to an appropriate discharge location. The hose must form a continuous fall.
- The heat pump must be installed using rigid pipes, suitable for use with heated pool water at working pressure that is expected of the water pump used for the pool system.
- All solvent cement joints must be made using suitable pressure (Type P) solvent cement and priming fluid. Other type of joints must be suitable for the water pressure, temperature and chemistry expected of the heat pump and the pool system.
- Keep the distance and the number of bends between the pool and the heat pump to a minimum.
- The heat pump must not be installed downstream of a chlorinator or other chemical dosing system. Warranty may not apply if the install did not follow this instruction.
- An adjustable bypass valve must be fitted between the inlet and the outlet of the heat pump.
- This heat pump must be connected to the mains electricity supply through a dedicated circuit with a lockable weatherproof isolating switch installed adjacent to, but not on the heat pump in accordance with the Wiring Rules.
- Adequate electrical protections including residual current protection and over current protection must be installed at the switchboard.

- Refrigerant gas leak test must be performed before and after installation. Do not install or operate the heat pump if any gas leak is detected.

### **Transportation and Storage**

- Always keep the heat pump upright, do not lay the unit on its side.

### **Maintenance Notice**

- All operators who dispose gas must be qualified by valid certification which issued by professional agency.
- Please strictly comply with the requirement from manufacturer when maintenance or filling gas.

### **Operation**

- If the power supply to the heat pump is interrupted during operation, the heat pump will automatically resume operation when the power is restored.
- The Henden Elevate Heat Pump can only be used to heat or cool pool water. It can NEVER be used to heat or cool flammable or turbid liquid.
- If any abnormal circumstances occurred, e.g.: abnormal noises, smells, smokes and leakage of electricity, switch off the main power immediately at the isolating switch and contact your local Reece Branch. Do not attempt to repair the heat pump.
- Please switch off the power to the heat pump at the isolating switch during a lightning storm.
- Error code E3 displayed on the heat pump controller is triggered when water flow is not detected by the water flow switch, and may not necessarily be a fault with the heat pump. The water pump must be operating for water flow to be detected by the heat pump.
- Excessive inlet and outlet temperature difference may result in poor energy efficiency and may reduce the life of the refrigerating system components. Set the bypass valve to achieve the recommended flow rate stated on the data plate.
- Condensation may form on the evaporator while the heat pump is operating. This is normal, and the condensate is collected at the base of the heat pump and discharged out of the unit via the condensate drain.
- During colder months, the evaporator coil may form frost. This is normal, and the heat pump may automatically initiate the defrost process to remove the frost off the evaporator. During the defrost process the heating operation is halted, water vapour may disperse from the heat pump and condensate may be discharged from the condensate drain. Once the frost is removed from the evaporator, the heat pump then automatically exits defrost process and resume the heating operation.

# 1. Specifications

Model	Henden Elevate Inverter Heat Pump 11kW	Henden Elevate Inverter Heat Pump 14kW	Henden Elevate Inverter Heat Pump 18kW	Henden Elevate Inverter Heat Pump 21kW	Henden Elevate Inverter Heat Pump 26W	Henden Elevate Inverter Heat Pump 32kW	Henden Elevate Inverter Heat Pump 40kW
Advised pool volume (m <sup>3</sup> )	25-40	31-50	41-60	51-75	61-85	76-110	86-140
Working air temp (°C)	-15 - 43						
<b>Performance Condition: Air 26°C, Water 26°C, Humidity 80%</b>							
Heating capacity (kW) in Turbo mode	11.0	13.5	17.5	21.5	25.5	31.5	40.0
Heating capacity (kW) in Smart mode	9.2	11.5	14.5	17.8	21.5	27.0	35.0
C.O.P in Smart mode	7.8	8.2	7.5	7.3	7.8	7.4	7.3
C.O.P	15.1-7.1	15.0-7.3	15.5-6.4	15.0-6.3	16.0-6.8	15.8-6.3	15.8-6.4
C.O.P at 50% capacity	11.4	11.6	11.2	11.2	11.3	11.2	11.1
<b>Performance Condition: Air 15°C, Water 26°C, Humidity 70%</b>							
Heating capacity (kW) in Turbo mode	7.5	9.0	11.3	14.3	17.5	21.5	28.0
Heating capacity (kW) in Smart mode	6.3	7.5	9.4	11.8	14.8	18.0	24.0
C.O.P in Smart mode	5.2	5.3	5.0	5.0	5.4	5.3	5.1
C.O.P	6.9-4.8	6.8-4.9	7.3-4.4	7.8-4.6	7.8-4.9	7.8-4.9	7.9-4.7
C.O.P at 50% capacity	6.5	6.5	6.6	6.8	6.8	6.8	6.7
<b>Performance Condition: Air 35°C, Water 28°C, Humidity 80%</b>							
Cooling capacity (kW)	4.4	5.6	6.5	8.0	11.6	13.6	16.0
<b>Electrical Rating</b>							
Power supply	230V /1Ph / 50Hz						400V / 3Ph / 50Hz
Rated input: Power (kW) / Current (A) Heating (top), Cooling (bottom)	2.0/8.70 1.6/6.95	2.45/10.65 2.10/9.13	3.15/13.70 2.40/10.43	3.70/16.09 2.70/11.74	4.05/17.61 3.50/15.22	4.75/20.65 4.0/17.39	6.50/9.72 5.50/8.82
Rated input power (kW) at air 15°C	0.18-1.53	0.22-1.8	0.26-2.56	0.31-3.08	0.38-3.53	0.46-4.4	0.60-5.94
Rated input current (A) at air 15°C	0.78-6.65	0.96-7.82	1.14-11.3	1.35-13.4	1.65-15.3	2.01-19.1	0.87-8.57
<b>Heat Pump Unit Details</b>							
Sound pressure at 1m dB(A)	38.5-45.5	38.6-46.9	42.0-47.7	42.9-50.8	40.8-51.2	43.3-51.9	42.5-51.7
Sound pressure of 50% capacity at 1m dB(A)	39.5	41.3	43.7	44.5	44.4	46.4	43.8
Sound pressure at 10m dB(A)	18.5-25.5	18.6-26.9	22.0-27.7	22.9-30.8	20.8-31.2	23.3-31.9	22.5-31.7
Advised water flow rate (m <sup>3</sup> /h)	2-4	3-4	4-6	6.5-8.5	8-10	10-12	12-18
Water connection pipe diameter (mm)	48.3						
Dimensions LxWxH (mm)	799x432x650	893x432x650	939x432x650	995x432x750	1125x429x952	1074x539x947	1260x539x947
Net Weight (kg)	51	61	65	70	98	102	126

*Note: The values shown are guide only and indicative under ideal conditions: Pool covered with an isothermal cover, filtration system running at least 15 hours a day. Consult a pool professional for sizing of heat pump appropriate for your pool system.*

*Note: Information contained in this table are subject to change without notice. For details please refer the data plate located on your heat pump.*

## 2. Dimensions

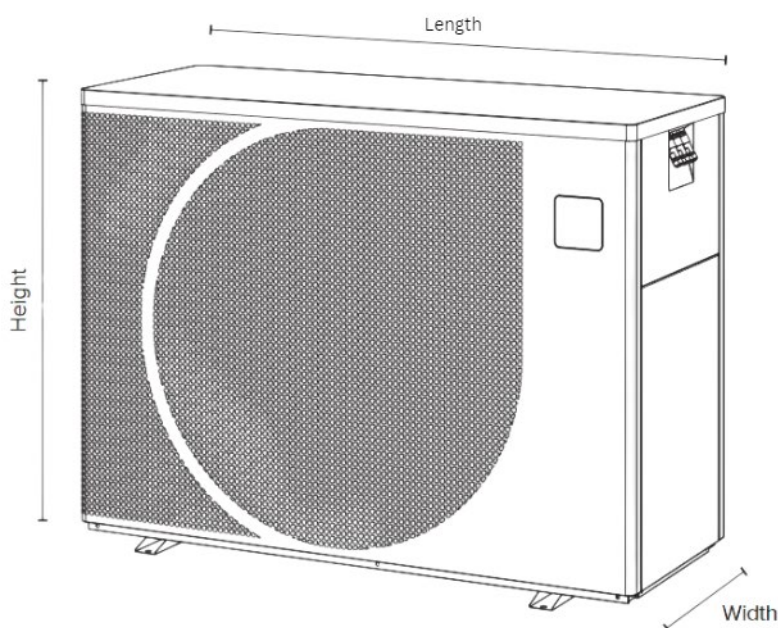

Dimensions							
Heater Model	11kW	14kW	18kW	21kW	26kW	26kW	26kW
Net Dimension L × W × H (mm)	799 ×	893 ×	939 ×	995 ×	1125 ×	1074 ×	1260 ×
	432 ×	432 ×	432 ×	432 ×	429 ×	539 ×	539 ×
	650mm	650mm	650mm	750mm	952mm	947mm	947mm
Net Weight (kg)	51kg	61kg	65kg	70kg	98kg	102kg	126kg

*Note: Information contained in this table are subject to change without notice.*

## 3. General Information

### 3.1. Contents

After unpacking the Henden Elevate Heat Pump, please check if you have all the following components.

- X1 Henden Elevate Heat Pump
- X2 Union tails
- X1 Drain barb
- X1 1.5 meter drain hose



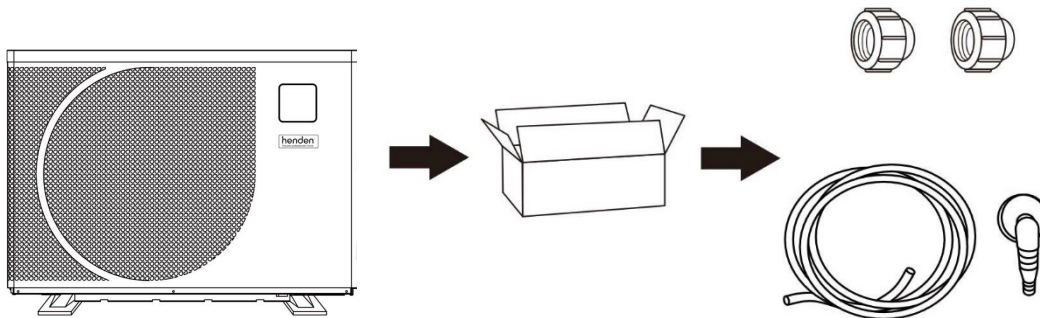

### 3.2. Operating conditions and set temperature range



ITEMS		RANGE
Operating range	Ambient air temp.	-15°C~43°C
Set temperature range	Heating	18°C~40°C
	Cooling	12°C~30°C

Note: The Henden Elevate Heat Pump will have ideal performance in the operation range:

**Air 15°C~25°C.**

### 3.3. Operating modes

The Henden Elevate Heat Pump has three modes - Turbo, Smart and Silence. These modes have different operating characteristics. See table below for a summary and recommended use.

Mode	Recommendation	Characteristics
	Turbo mode	Heating capacity: 20% to 120% Fast heating
	Smart mode Use as standard	Heating capacity: 20% to 100% capacity Intelligent optimization
	Silence mode Use at night	Heating capacity: 20% to 60% capacity Sound level: 3dB(A) lower than Smart mode.

## 4. Installation and connection

### 4.1. Minimum clearance requirements

Install the Henden Elevate Heat Pump in accordance with the minimum clearance requirements below.

Front: 500mm

Back: 300mm

Sides: 300mm

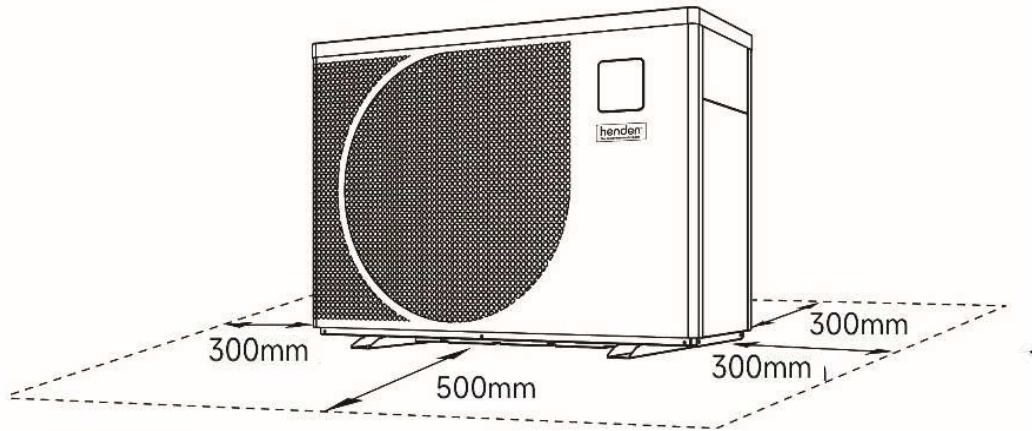

### **WARNING**

Never install the Henden Elevate Heat Pump in a closed room with a limited air volume in which the air expelled from the unit will be reused, or close to an object that could block the air movement. Such locations impair the continuous supply of fresh air, resulting in reduced efficiency and possibly preventing sufficient heat output.

### 4.2 Distance from swimming pool

For optimal heating, install the Henden Elevate Heat Pump within 10m from the swimming pool.

Note: A rough estimate of the heat loss per 30 m is 0.6 kWh (2,000 BTU) for every 5 °C difference between the water temperature in the pool and the temperature of the soil surrounding the pipe. This increases the operating time by 3% to 5%.

### Connecting the Unions

- a. Unscrew the unions located on the side back of the Henden Elevate Heat Pump. Check that the o-rings are fitted on the connection points.

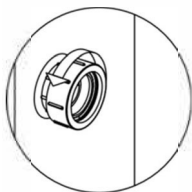

b. Attach the supplied union tails to the inlet and outlet of the Henden Elevate Heat Pump. Check to ensure the sealing surfaces are clean and free of dirt and debris.

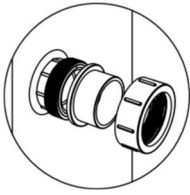

c. Reattach the union to the inlet and outlet of the Henden Elevate Heat Pump, hand tighten to secure. Do not use tools to tighten the unions.

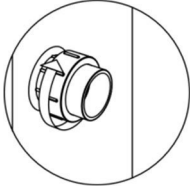

### Connecting the Drain Hose

a. Connect the drain barb to the drain hose.

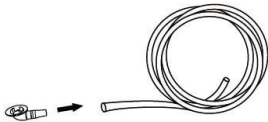

b. Locate the barb condensate drain thru-hole under the Henden Elevate Heat Pump and push the supplied drain hose elbow on securely. Do not tilt the heat pump.

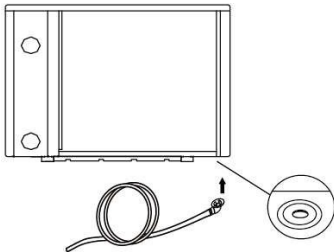

c. Run the drain hose to an appropriate discharge point while maintaining a continuous fall.

### ⚠ Attention:

- Any dosing of chemicals must take place in the piping located downstream from the Henden Elevate Heat Pump.
- Install an adjustable bypass between the inlet and the outlet connections.
- Install an isolation valve adjacent to each connection point.
- Install the Henden Elevate Heat Pump on a solid foundation and raise above the ground using suitable supports to secure access to the condensate drain.

- Always keep the Henden Elevate Heat Pump upright. If the unit has been tilted at an angle, wait at least 24 hours before starting the heat pump.

### 4.3. Water pipe connections:

Note: The inlet and outlet water connections on the Henden Elevate Heat Pump must not take the weight of the water pipes. The heat pump must be connected using rigid pipes and the weight of the pipes must be supported independently.

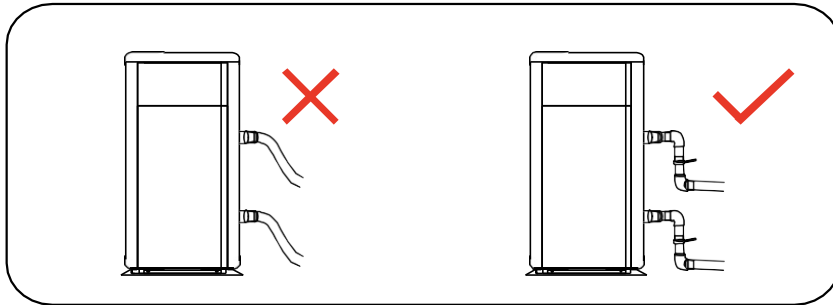

Use only pressure PVC or equivalent plastic pipes that are capable of withstanding the pressure and temperature expected from the pool system and the heat pump.

Connection to the heat pump union tails must be made using Type P solvent cement in conjunction with a suitable priming fluid.

### 4.4. Installation instruction

#### 4.4.1 Henden Elevate Heat Pump installation.

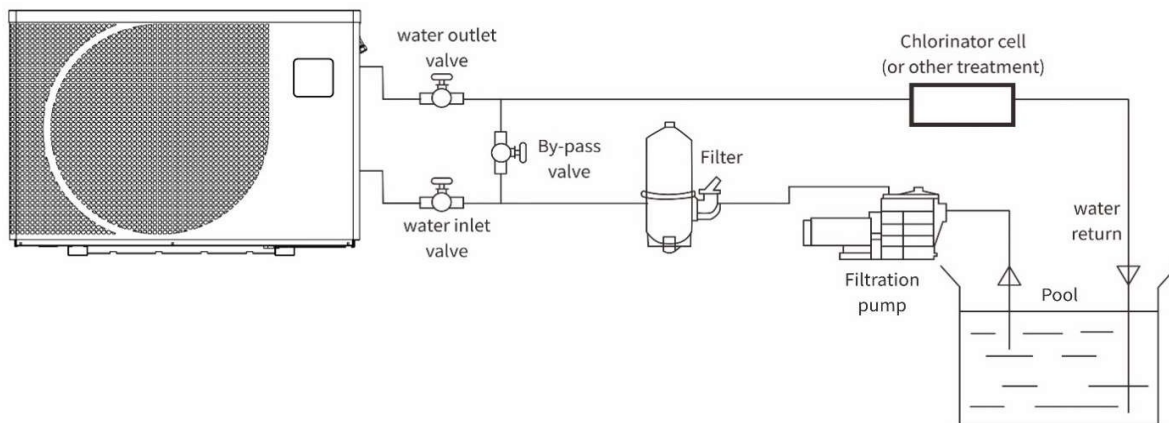

#### Note:

- Anchor points on the heat pump are sized for M10 fasteners. Fasteners used must be suitable for outdoor conditions.
- The Henden Elevate Heat Pump requires a water pump to operate (not supplied). The water pump must be sized to meet the flow rate requirement of the heat pump, as well as other equipment installed in the pool system. Approximate pressure drop across the heat pump is less than 10kPa at the recommended flow rate.

#### 4.4.2 External Connectors Installation

Depending on the type of pool heating and cooling requirements, the Henden Elevate Inverter Heat Pump may be operated by external controller.

There are 3 connectors on the side of the unit. These are for external control, RS485 and Pump Control.

- Ext. Control - a dry contact that when closed the heat pump initiates heating/ cooling, and when open the heat pump terminates heating/ cooling. This connector is pre-fitted with a bridging cable which needs to be removed if used with an external controller.
- RS485 - used in conjunction with an external controller with Modbus support.
- Pump Control - a dry contact for controlling water pump using heat pump control logic.

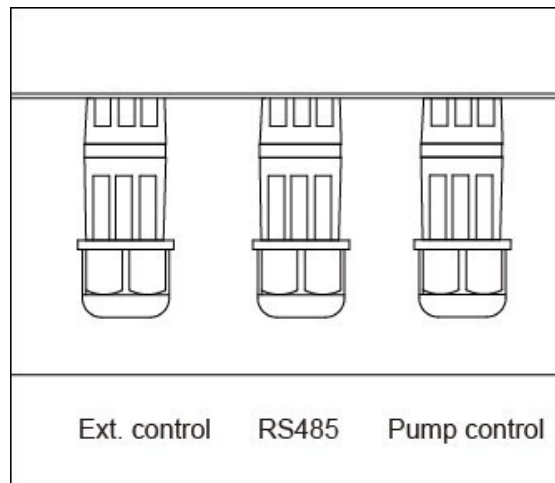

**Warning:** Above connections are suitable only for use with extra-low voltage. Mains power supply connection must not be made to the connectors

#### 4.4.3 Disassembling and connecting the signal wire

a. Follow the diagram below to disassemble to connection point.

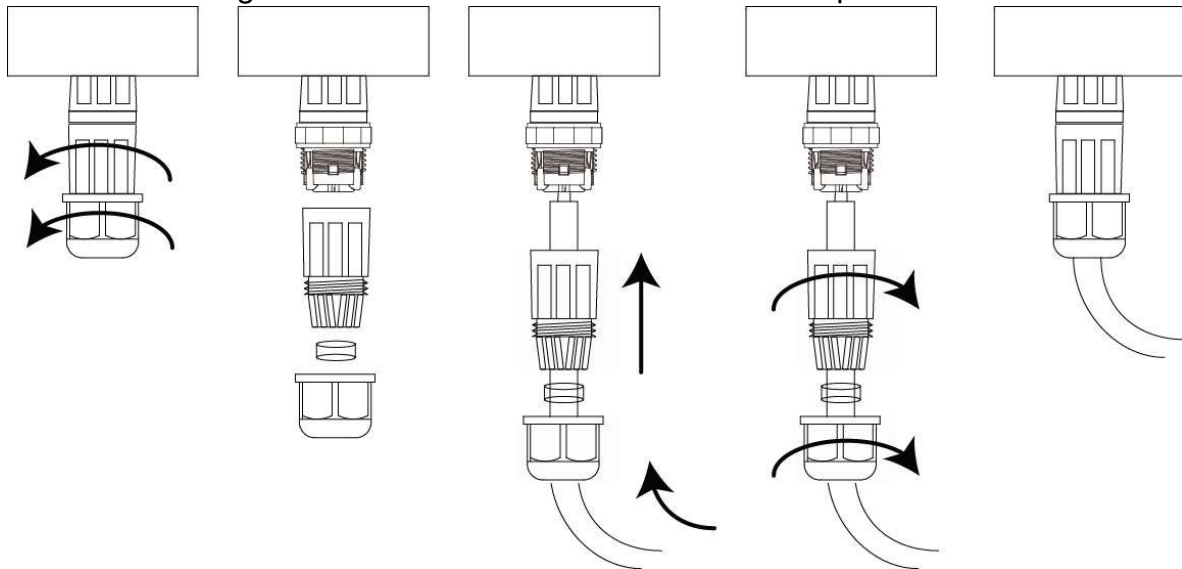

## b. Wiring cables to the connectors

Each connector has a different terminal layout. Follow the direction below.

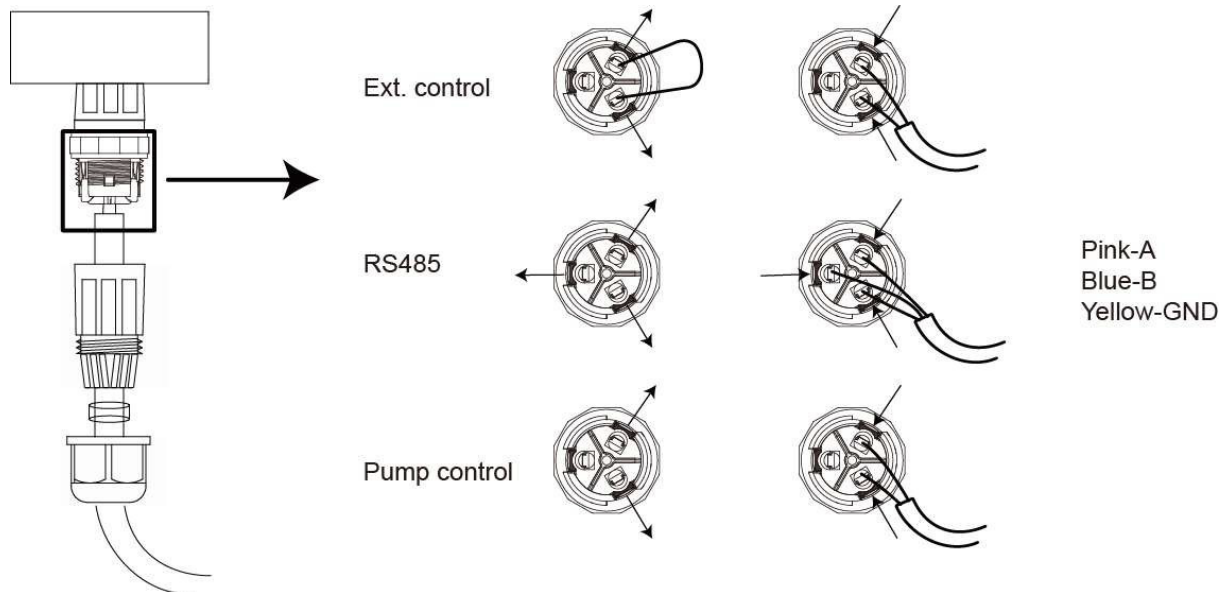

### a) Wiring Ext. Control Cable to the connector

After disassembling the connection point, pull the operation key outward. Remove the original wiring and connect the signal wire to the Pink and Blue Port. Once complete, push the operation key inward to lock the signal wire. ( Outer diameter dimension of the signal wire : 5-9MM )

### b) Wiring RS485 to the connector

After disassembling the connection point, pull the operation key outward. Connect the corresponding signal line according to the terminal of the corresponding colour. Once complete, push the operation key inward to lock the signal wire. ( Outer diameter dimension of the signal wire : 3.5-7MM )

- Pink is connected to signal line A
- Blue is connected to signal line B
- Yellow is connected to GND signal line

### c) Wiring Pump Control to the connector

After disassembling the connection point, pull the operation key outward. Remove the original wiring and connect the signal wire to the Pink and Blue Port. Once complete, push the operation key inward to lock the signal wire. ( Outer diameter dimension of the signal wire : 5-9MM )

Note: Hold the body of the connector in place while tightening the lower cover and loose nut to prevent the connector body from turning.

Note: If a connector is not used, check that the plug is fitted in the cable entry point and tighten the loose nut

#### 4.4.4. Wiring, protecting devices and cable specification



**WARNING!** Electrical installation must only be carried out by a licensed electrician. Electrical Installations must be in accordance with the Wiring Rules and local regulations.

- a. Install a dedicated permanent wiring from the switchboard to the heat pump in accordance with the Wiring Rules. The power supply cable must be sized to safely carry the maximum input current from the heat pump, refer to the data plate the detail. Residual current device (RCD) and other electrical protection devices must be fitted at the switchboard. A lockable isolating switch must be installed adjacent to, but not on the heat pump. Electrical installation must be sufficiently protected from any adverse effects from the environment such as weather, heat and corrosion, over the life of the heat pump and the pool system. Sizing table below has been prepared as a reference, and it is to be used as a guide only.
- b. Remove the outer panel cover located on the side of the heat pump, then remove the electrical supply enclosure cover to access the mains electrical supply terminals. Create an electrical connection from the isolation switch. The cable entry point is located on the rear of the unit. Attach the covers back on the heat pump.
- c. Check for acceptable earth continuity between the heat pump accessible metal parts and a known earth point. Equipotential bonding in accordance with the Wiring Rules may be required for this heat pump.

MODEL		Henden Elevate Heat Pump 11kW	Henden Elevate Heat Pump 14kW	Henden Elevate Heat Pump 18kW	Henden Elevate Heat Pump 21kW	Henden Elevate Heat Pump 26kW	Henden Elevate Heat Pump 32kW	Henden Elevate Heat Pump 40kW
Protection Device	Over current (A)	12.0	15.0	19.0	22.5	24.5	30.0	15.0
	Max. residual current (mA)	30	30	30	30	30	30	30
Max input current (A)		10.0	12.5	16.0	18.5	20.5	25.0	12.5
Power cord (mm <sup>2</sup> )		3x2.5	3x2.5	3x2.5	3x4	3x4	3x6	5x2.5
Signal cable (mm <sup>2</sup> )		3x0.5	3x0.5	3x0.5	3x0.5	3x0.5	3x0.5	3x0.5

NOTE: This table is to be used as a guide only. Sizing must be assessed by a licensed electrician in accordance with the Wiring Rules appropriate for the install site. The above data is adapted to power cord  $\leq 5m$ . If power cord is  $>5m$ , wire diameter must be increased. The signal cable can be extended to 50m at most.

## 4.5. Commissioning

### Before operating the heat pump

- a. Check installation of the heat pump including condensate drain. Check the inlet and the outlet pipe connections are correct.
- b. Check installation of the pool system, including the water pump, water treatment system, filtration system and controller.
- c. Check the electric supply wiring, earth continuity and equipotential bonding, where required, are completed by a licensed person for the heat pump and other equipment for the pool system.
- d. Remove any obstacles around the air inlet and outlet.

### Commissioning checklist

- a. Before turning on the heat pump, ensure that the heat pump water circuit is completely filled with water. Any air left in the pipework may cause airlock or cavitation in the water pump.
- b. Open isolation valves to the heat pump and close the bypass valve. Turn on the water pump. Check that the water is circulating between the pool and the heat pump. Check and rectify any water leak.
- c. Supply power to the heat pump. Turn on the heat pump by pressing the power button on the controller display and set the desired pool temperature.

Note: In order to protect the internal mechanism, the heat pump is equipped with a start delay function. At startup, the water pump runs for 3 minutes, then the fan operates for 30 seconds. The compressor is then energised, and will reach 100% capacity within the first 2 minutes of operation.

Note: Water pump should turn on before the heat pump turns on and the water pump should turn *off* after the heat pump turns off.

- d. For optimal energy efficiency, adjust the bypass valve to achieve the recommended water flow rate through the heat pump shown on the data plate. Alternatively, adjust the bypass valve to achieve the inlet and outlet temperature **difference of 2°C to 3°C** at 100% compressor capacity.
- e. In heating mode, the air discharged from the heat pump is cooler than the ambient air. In cooling mode, the air discharged from the heat pump is hotter than the ambient air. The difference in the air temperature can be felt by hand at the discharge point.
- f. Check for any abnormal noise from the heat pump.
- g. Observe the temperature of the pool rise (in heating) or fall (in cooling).
- h. Turn *off* the heat pump by pressing the power button on the display controller. Observe the compressor and the fan reduce in speed until stopped completely.
- i. Turn *off* the water pump. Isolate power supply to the heat pump and observe the display turn off.

Note: Above commissioning procedure may differ if the heat pump is operated using an external controller. Refer instructions supplied with the external controller on how to turn on and off the heat pump and other equipment used in the pool system.



## 4.6. Maintenance and winterizing

### 4.6.1. Maintenance

Isolate the power supply before commencing any maintenance work. Do not touch the electronic components until the **LED** indication lights on PC Board turn off.

Any maintenance work involving removal of panels and covers must only be carried out by a qualified person.

WHEN	WHAT ARE YOU LOOKING FOR	HOW CAN YOU FIX IT
Daily	General tidiness	Maintain the heat pump in good working condition. Household detergent may be used to clean the exterior of the heat pump. Do not spray water inside the heat pump.
Weekly	Check around the unit for leaves/debris and blocked drain.	Remove any debris that is restricting air circulation around the Henden Elevate Heat Pump. Inspect and rectify the condensate drain blockage.
Quarterly	Check all gaskets	Isolate and turn off the heat pump. Remove all gaskets and turn over. You can also apply a silicon-based grease to extend the life. If dry, then contact your local pool professional to replace.
	Check for any insects/ants and weed growth	Inspect and rectify the heat pump and surroundings for insect infestation and weed growth. Any insect removing and weed removing chemical used must not be flammable and only apply around the heat pump. Avoid applying chemical on or inside the heat pump.
	Check for any leaks	If you notice any water leaking from the heat pump, check gaskets and reseal. If continues, contract your local pool professional to assess and rectify.
Annually	Clean the evaporator coil and fan	Isolate and turn off the heat pump. Use a soft cloth with water containing a small amount of household detergent to carefully clean the entire outside of the unit, especially the evaporative coils and fan.
Pool system	Skimmer box	Inspect and clean the strainer as needed.
	Water pump strainer basket	Inspect and clean water pump strainer basket as needed, but not less than the frequency stated on the manufacturer's instructions. Follow the procedures outlined in the manufacturer's instructions.
	Cartridge / Media filter	Clean filter as needed, but not less than the frequency stated on the manufacturer's instructions. Follow the procedures outlined in the manufacturer's instructions.
	Chlorinator / treatment system	Follow the maintenance frequency and procedures outlined in the manufacturer's instructions.

#### 4.6.2. Winterising

If you live in a climate where your temperature is low enough to freeze the pool, it is important to winterize your Henden Elevate Heat Pump when not in use. Failure to follow these steps could result in water freezing inside the unit, and causing potential damage. Heat pump failure due to water freezing may not be covered under warranty.

To prepare your heat pump for freezing conditions:

- Isolate the power supply to the Henden Elevate Heat Pump.
- If the heat pump is positioned below the pool water level, ensure the inlet and outlet valves are turned off.
- Disconnect the inlet and outlet unions from the heat pump and let water drain out of the heat pump.
- When the water is completely drained from the heat pump, tighten the inlet and the outlet unions.

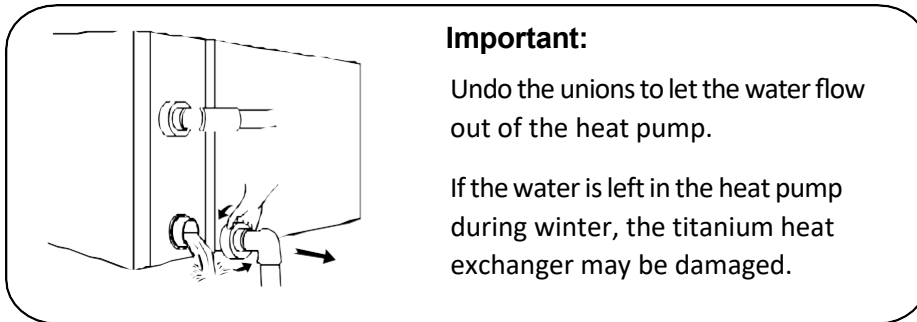

Note: When using the Henden Elevate Heat Pump under 2°C, make sure there is always water flow circulating the pool system.





## 5. Operation

### 5.1. General Information

- For improved service life, ensure the water pump is turned on before the heat pump is turned on, and the water pump is turned off after the heat pump is turned off.
- Check to ensure no water leak from pipework, then unlock screen and power on the heat pump
- The air drawn into the heat pump is cooled by the operation of the heat pump to heat the pool water, which may cause condensation on the fins of the evaporator. The amount of condensation may be as much as several liters per hour at high relative humidity. This is sometimes mistakenly regarded as a water leak, rather is a normal operating condition.

## 5.2. Operation instructions



Symbol	Designation	Function
	ON/OFF	<ol style="list-style-type: none"> <li>1. Power On/Off</li> <li>2. Wi-Fi setting</li> </ol>
	Lock/Unlock Mode Selection	<ol style="list-style-type: none"> <li>1. Press and hold for 3 seconds to unlock/lock screen</li> <li>2. After screen is unlocked, press to select mode: <ul style="list-style-type: none"> <li>• Auto - set temperature 12-40°C</li> <li>• Heating - set temperature 18-40°C</li> <li>• Cooling - set temperature 12-30°C</li> </ul> </li> </ol>
	Speed	Select Turbo/Smart/Silence mode
	Up/ Down	Adjust set temperature

### Screen lock:

- If no operation for 30 seconds, screen will be locked.
- When heat pump is off, screen will be dark and "0%" will be displayed.
- Press  for 3 seconds to lock screen and it will be dark.

### Screen unlock:

- Press  for 3 seconds to unlock screen and it will light up.
- Button operations are disabled until the screen is unlocked.

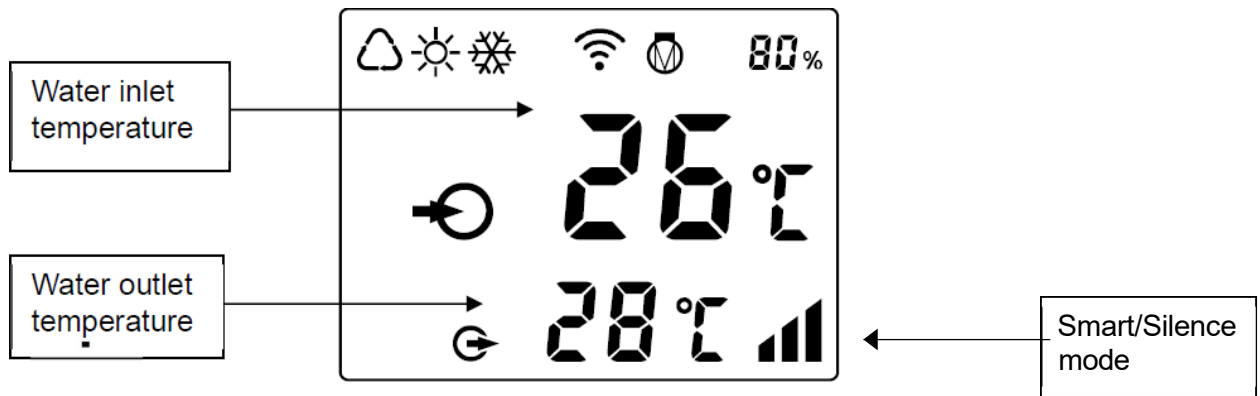

	Auto
	Heating
	Cooling
80%	Compressor capacity percentage
	Wi-Fi connection
	Water inlet
	Water outlet

#### Power On:

- Press for 3 seconds to unlock the screen.
- Press to turn on the heat pump.

#### Adjust Set Temperature:

- Ensure screen is unlocked.
- Press or to display and adjust the set temperature.

#### Mode Selection:





- Press to select mode.

Auto adjustable temperature range 12-40°C

Heating : adjustable temperature range 18-40°C

Cooling : adjustable temperature range 12-30°C

Turbo/Smart/Silence mode selection:



- a. Turbo mode is set as the default and will be active when heat pump is first turned on, and screen shows . Turbo mode will operate up to 120% of the compressor capacity.
- b. Press  to enter Smart mode, and screen shows . Smart mode will operate the compressor capacity up to 100%.
- c. Press  to enter Silence mode, and screen shows . Silence mode will limit the compressor capacity to 80% and operate at reduced sound level.

Note: Suggest using Turbo mode initially for faster water heating





### Defrost

During colder months, a buildup of frost may develop on the evaporator due to the moisture that is in the air. The buildup of frost may impede on the air flow over the evaporator fins hence the Henden Elevate heat pump is integrated with a defrost strategy.

#### a. Auto Defrost:



When the heat pump is defrosting,  will be blinking on the screen. When the defrosting is complete,  will stop blinking.

#### b. Manual Defrost:

When the heat pump is heating, press  and  together for 5 seconds to start manual defrost, and  will start blinking. After defrosting,  will stop blinking.

Note: Manual defrost intervals should be more than 30 minutes and the compressor should run for more than 10 minutes in heating mode.)

### Temperature unit conversion between °C and °F:

- a. Press  and  together for 5 seconds to switch the unit between °C and °F.

## 6. Wi-fi/App connectivity

### 6.1. Download the \*Henden Heat Pump\* App

Android Mobile please download from

iPhone please download from

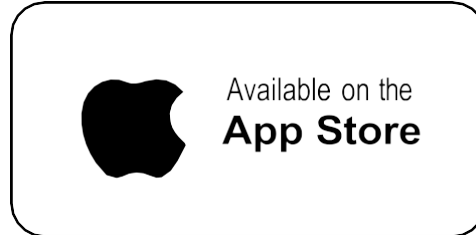

### 6.2. Account registration

#### a) Registration by Cell phone number/Email





### 6.3. Create family

Set a name for the family and choose the room of the device.

Note: There are three methods of device binding, auto discovery (Bluetooth), EZ Mode (easy-connect) and AP mode. Connect your phone to the Wi-Fi network first.





### 6.3.1 Auto Discovery (Bluetooth)

- Make sure the Bluetooth function is enabled on your phone
- Press  for 3 seconds after the screen unlock,  will be flashing rapidly to enter Wi-Fi binding status.
- Click "Add Device", wait for the app to search for the device and then click "add", then follow the instructions below to finish the device binding.

#### Note:



- It will take some time to scan, please be patient.
- Only Wi-Fi modules with Bluetooth functions can use this method.

### 6.3.2. EZ Mode (Easy-connect)

- Activate the Wi-Fi module
- Press  for 3 seconds after the screen unlocks,  will be flashing rapidly to enter Wi-Fi binding status.
- Click "Add device", and follow the instructions below to finish binding.  display on the screen once the Wi-Fi connection success.

**Note:** After allowing the APP to locate, it can read the Wi-Fi name automatically.



### 6.3.3. AP Mode

- Activate Wi-Fi module
- Press  for 10 seconds after the screen unlock,  will be flashing slowly to enter Wi-Fi binding status.
- Click "Add device", and follow the instructions below to finish binding.  display on the screen once the Wi-Fi connection success.

**Note:** If it doesn't jump automatically, click "Confirm hotspot connection, next".

If connect fails, please make sure your network name and password are correct. And your router, mobile phone and device are as close as possible.

### 6.3.4. Wi-Fi rebinding (When Wi-Fi password changes or network configuration changes)

- Press  for 10 seconds,  will be flashing slowly for 60 seconds.
- Then  will be off. The original binding will be removed. Follow steps above for rebinding.

**Note:** Please make sure the router is configured at 2.4 GHz.

### 6.4. Operation instructions

The following instructions are for heat pumps with heating and cooling functions.

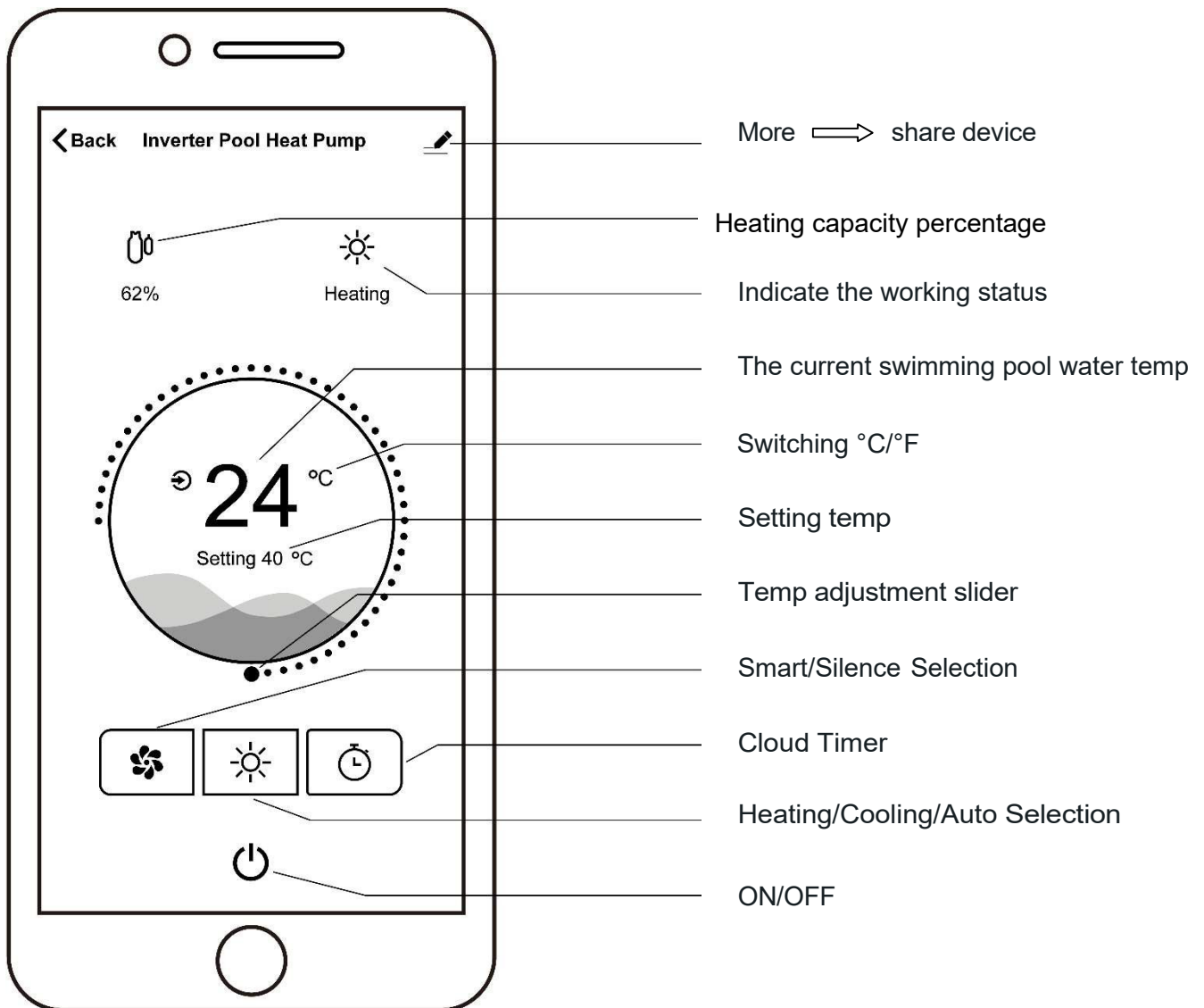







## 6.5. Share devices with your family members

1. Get your family member to download the app.
2. In your master app, click the pencil in the top right hand of the home screen.
3. Select the option 'Create Group'. Select 'Add Device' and follow the prompts to add the family member by entering their phone number.

**Note:** The app is subject to change without warning.





## 6.6. Advanced application

### Parameter Checking

- a. Press  and  together for 5 seconds to enter "Parameter Checking" status, the parameter code "P0" and the parameter value "0" will display on the screen.
- b. In "Parameter Checking" status, press  or  to check the parameters.

### Parameter Modification

 Do not make adjustment to the parameters listed below. Only a qualified person with understanding of the appliance should make adjustment based on the site requirement.

- a. In "Parameter Checking" status, press  to enter the "Parameter Modification" mode.
- b. Press  or  to change the values, then press  to confirm and quit "Parameter Modification" mode.
- c. Press  to quit "Parameter Checking" status.

## 6.7. Parameter list

NO.	Content	Adjust range	Step length
P0	Water Pump Running Way	0: Continuous 1: Water temp control 2: Time/water temp control	1
P1	Time Setting (Only available when the water pump running way is set to "2")	10 - 120 min	5 min
P2	Compressor Continuously Running Time between Defrosting Mode	30 - 90 min	1 min
P3	Defrosting Entry Temp	-17-0°C	1°C
P4	Maximum Defrosting Running Time	1 - 12 min	1 min
P5	Defrosting Exit Temp	8-30°C	1°C

### Running status checking

a. Press  for 5 seconds, enter into "Running status checking", and the screen alternately shows status point "C0" and its corresponding value that is inlet water temperature, currently measured by the inlet water temperature sensor.

b. Scroll through the status and their corresponding value by pressing  or 

Press  to quit "running status checking" mode.

Running status checking list





Symbol	Content	Unit
C0	Inlet water temp.	°C/ °F
C1	Outlet water temp.	°C/ °F
C2	Ambient temp.	°C/ °F

C3	Exhaust temp.	°C/ °F
C4	Outer coil pipe temp. (Evaporator)	°C/ °F
C5	Gas return temp.	°C/ °F
C6	Inner coil pipe temp. (Titanium heat exchanger)	°C/ °F
C9	Cooling plate temp.	°C/ °F
C10	Electronic expansion valve opening	p
C11	DC fan speed	(r/min)

## 7. Troubleshooting

### 7.1. Protection Codes

The following codes may be displayed on the screen from time to time and they do not necessarily represent failures of the heat pump, rather these protect the heat pump from operating outside of its safe operable conditions. Check and rectify the condition in which the heat pump is attempting to operate in, for instance E3 may be due to water pump not turned on to provide water flow to the heat pump.

	Codes
No water protection	
Anti-Freezing Protection	
Out of the operating range	
Insufficient water flow protection	
Power abnormal	

## 7.2. Issues which do not result in error code

Failure	Reason	Solution
Henden Elevate Heat Pump doesn't run	No power	Wait until the power recovers
	Power switch is off	Switch on the power
	Fuse burned	Call Henden distributor or call aftersales
	The breaker is off	Check and turn on the breaker
Fan running but with insufficient heating	evaporator blocked	Remove the obstacles
	Air outlet blocked	Remove the obstacles
	3 minutes start delay	Wait patiently
Display normal, but no heating	Set temp. too low	Set proper heating temp.
	3 minutes start delay	Wait patiently
If above solutions don't work, please contact your installer with detailed information and your model number.		

## 7.3. Error code list

NO.	Display	Error code description (not failure)
1	E3	No water protection
2	E5	Power supply excesses operation range
3	E6	Excessive temp difference between inlet and outlet water (insufficient water flow protection)
4	Eb	Ambient temperature too high or too low protection
5	Ed	Anti-freezing reminder
6	OFF	Customer Control Switch DIN2 Disconnect
NO.	Display	Error code description
1	E1	High pressure protection
2	E2	Low pressure protection
3	E4	Phases lack protection (three phase model only)
4	E7	Water outlet temp too high or too low protection
5	E8	High exhaust temp protection
6	EA	Evaporator overheat protection (only at cooling mode)
7	PO	Controller communication failure
8	P1	Water inlet temp sensor failure
9	P2	Water outlet temp sensor failure
10	P3	Gas exhaust temp sensor failure
11	P4	Heating (Evaporator)coil pipe temp sensor
12	P5	Gas return temp sensor failure

13	P6	Cooling (Titanium heat exchanger) coil pipe temp sensor
14	P7	Ambient temp sensor failure
15	PB	Cooling plate sensor failure
16	pg	Current sensor failure
17	PA	Restart memory failure
18	F1	Compressor drive module failure
19	F2	PFC module failure
20	F3	Compressor start failure
21	F4	Compressor running failure
22	F5	Inverter board over current protection
23	F6	Inverter board overheat protection
24	F7	Current protection
25	F8	Cooling plate overheat protection
26	F9	Fan motor failure
27	Fb	Capacitor no charging protection
28	FA	PFC module over current protection
29	8888	Communication failure

## 8. Appendix

### A. Heat Pump 11kW ~ 18kW Wiring Diagram

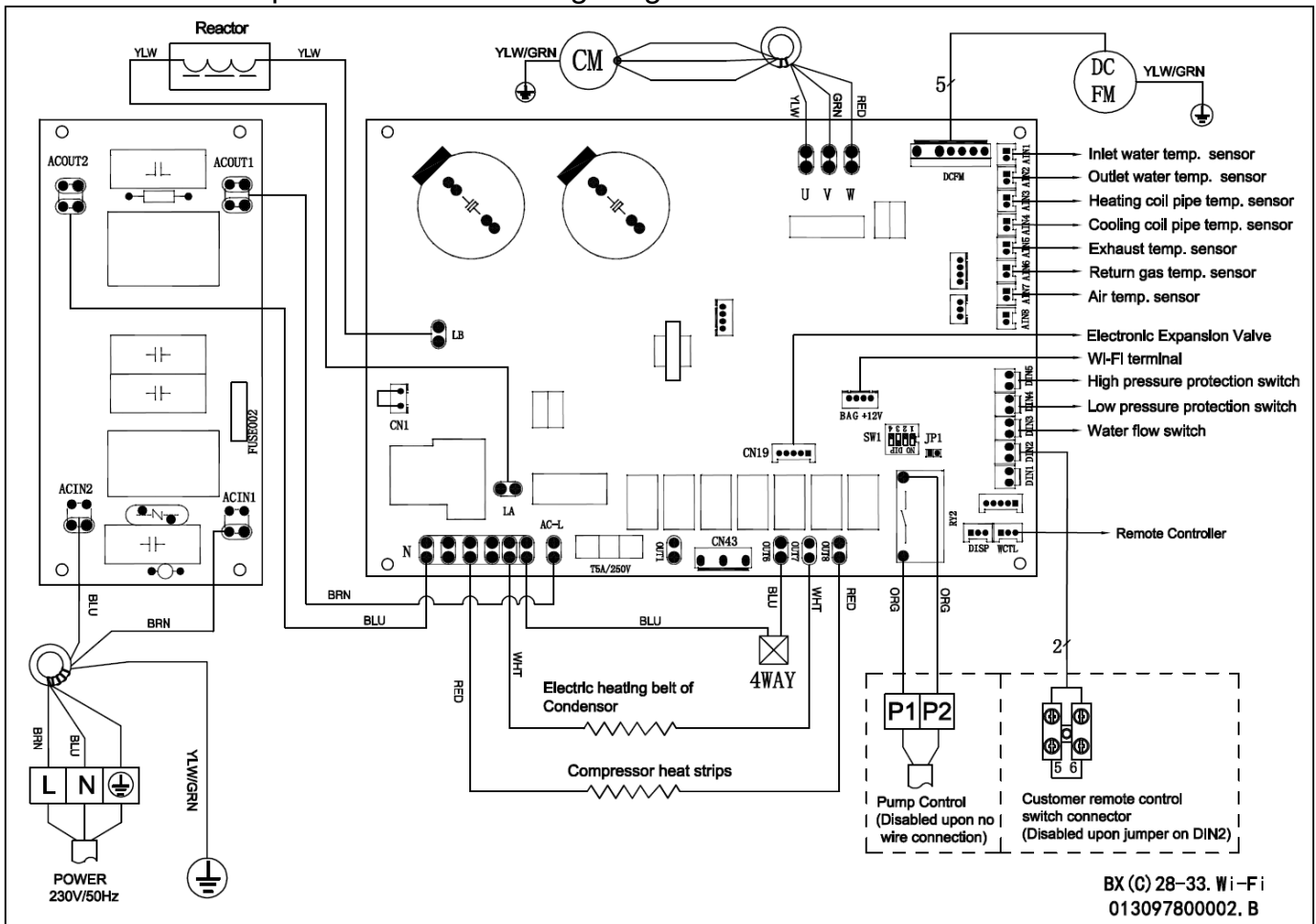



## 9. Warranty



### Henden Elevate Heat Pump

#### Reece Australia Product Quality Guarantee

You have purchased a quality product from Reece Australia Pty Ltd ABN 84 004 097 090 ("Reece Australia").

#### Warranty Terms & Conditions

These Warranty Terms and Conditions ("Warranty") constitute your agreement with Reece Australia and will apply to your service order. The benefits given by this Warranty are in addition to all consumer guarantees and other rights and remedies prescribed by the Australian Consumer Law and any other applicable laws.

Our goods come with guarantees that cannot be excluded under the Australian Consumer Law. You are entitled to a replacement or refund for a major failure and compensation for any other reasonably foreseeable loss or damage. You are also entitled to have the goods repaired or replaced if the goods fail to be of acceptable quality and the failure does not amount to a major failure.

In addition to your rights and remedies under the Australian Consumer Law, Reece Australia provides consumers with a Warranty which covers faults in product construction, materials and assembly in the following applicable warranty periods:

Residential Application*	Warranty			
	Heat Exchanger	Compressor	Componentry	Labour
Henden Elevate Heat Pump	25 Year*	10 Year	5 Year	1 Year

Commercial Application*	Warranty			
	Heat Exchanger	Compressor	Componentry	Labour
Henden Elevate Heat Pump	1 Year	1 Year	1 Year	1 Year

\*Residential Application defined using as: Any structure containing water to a depth greater than 300mm and used primarily used for swimming, wading, padding or the like, including a bathing or wading pool, or spa pool.

\*Commercial Application defined as Any other use of the product other than defined in the residential application is considered to be a commercial application.

\*25 Year Titanium heat exchanger warranty against corrosion (casing of heat exchanger is covered for 2 years).

## Warranty Periods

The Warranty Periods commence from the date the customer purchased the product from Reece Australia. Within the Warranty Periods, products which are found upon inspection by an authorised Reece Australia representative or an associated licensed technician supplied by either Reece Australia or a relevant supplier ("Service Agent") to be defective in construction, material, or assembly, will be repaired or exchanged with an equivalent product at no cost to the customer.

Parts of products found upon inspection by a Service Agent to be defective in construction, material, or assembly, will be replaced at no cost to the customer. The labour for the replacement of products and parts to which this Warranty applies will be carried out by a Service Agent. Where the Service Agent is unable to identify any fault in the product, Reece Australia may require the consumer to provide proof that the product is defective.

## Warranty Conditions

This Warranty applies only if the following conditions are met:

- The heat pump was installed by a fully qualified technician
- The electrical installation was carried out by a licensed person in accordance with the Australian Wiring Rules (AS/NZS 3000)
- The heat pump was installed in accordance with this installation instructions, relevant Australian Standards, the building codes (NCC) and any local regulatory requirements
- The heat pump was operated and maintained in accordance with this operating instructions, including the following:
  - Regular cleaning and maintenance of the pool system and the heat pump
  - Regular maintenance of the pool water chemistry
  - Ensuring that the air inlet and outlets of the heat pump unit was cleaned regularly to clear any obstructions (e.g. dirt, leaves, plants)
  - Ensuring that the condensate drain was kept clean and clear
  - Applying additional corrosion protection if the heat pump unit was installed in a corrosive environment (e.g. industrial pollution, sea air)
  - The heat pump was operated for its intended use
- The heat pump was not modified, other than service replacement work carried out by an authorised person
- Failure was due to a fault in the manufacture of the product
- The heat pump was returned in good condition and has not arrived damaged by transit, if required by Reece Australia to conduct failure analysis
- Proof of purchase (including the date of purchase and the serial number of the heat pump are provided)

This Warranty does not cover faults caused by:

- Failure to adhere to the conditions specified above
- Normal wear and tear of the product
- Damage to external and internal components by foreign objects
- External damage caused by exposure to pool chemicals
- Inadequate or complete lack of maintenance of the heat pump and the pool system
- Failure to maintain appropriate pool water chemistry
- Chemical, electrochemical or electrical influences
- Harsh detergents or abrasive cleaners used on product finishes
- Inadequate protection of the heat pump from weather
- Incorrect installation or installation not in accordance with this installation instructions including clearance requirements to maintain proper airflow



- Installation carried out by unqualified technician
- Electrical installation carried out by a person without appropriate electrical license
- The heat pump was operated outside of its intended use
- Inadequate heating / cooling of swimming pool due to undersized heat pump
- Inadequate heating / cooling of swimming pool due to insufficient insulation of pipework, excessively long pipework and/or lack of appropriate pool thermal cover
- Lack of understanding by the installer or the user about the heating and cooling capacity of the purchased heat pump and the typical time required to condition the pool water temperature to setpoint
- Faults or substandard performance caused by any product or part which has not been supplied by or purchased from Reece Australia
- The heat pump was modified, other than service replacement work carried out by an authorised person
- Deterioration and/or damage to the external surfaces or refrigeration coils cause by normal weathering or corrosive atmospheric conditions
- Faults or substandard performance caused by vermin ingress, misuse, negligence, vandalism, storm, flood, fire, earthquake, force majeure, war, foreign matter entering the heat pump (e.g. detritus, dirt and moisture) or any other outside agency
- Faults or substandard performance caused by faulty or incorrect external electrical wiring, incorrect power supply, voltage fluctuations, over voltage transients or electromagnetic interference not originating within the heat pump

This Warranty does not cover 'ex display' products where the ex-display products have not been checked and certified for sale by the manufacturer prior to purchase.

For the avoidance of doubt, defective items become Reece Australia's property.

### **Claim Procedure**

In order to claim the Warranty, you must cease using the product when a fault arises, contact the Reece Australia branch where the product was purchased to report the issue and follow Reece Australia's directions regarding what to do next. The relevant Reece Australia branch details can be found on your purchase invoice. You must also provide the product serial number.

Reece Australia's general contact details are as follows:

For a complete list of Reece Irrigation & Pools branches visit our website

**reece.com.au/storefinder**

**Technical and after sales support:** 1300 131 788

**Mailing/manufacture address:** The Reece Group, 57 Balmain Street, Cremorne, VIC, 3121, Australia.

If applicable, all replacement products will be available for collection at no cost to the customer at the nearest Reece Australia branch to the customer's location, or elsewhere as agreed between the customer and Reece Australia.

## **Labour**

Warranty for installation labour is twelve (12) months from date of purchase.

All replacement parts/ components will be supplied direct by Reece Australia. Should the buyer purchase parts/ components from their own supplier the company may at their own discretion reject or reimburse the cost to which the company can purchase the part for.

## **Costs**

The customer will be responsible for any ancillary costs associated with making a warranty claim, such as:

- Any travel outside of the area normally serviced by Reece Australia or any associated Service Agent authorised by Reece Australia
- All costs related to gaining access to unsafe (e.g. high) or restricted locations
- Any and all arrangements required to create safe access for the Service Agent to service the product; this includes making clear access to and from the unit (e.g. moving furniture etc.)

Excessive labour costs due to job conditions that make the equipment unusually inaccessible or otherwise difficult to source is NOT covered under this policy. The equipment must be readily accessible to the Service Agent, that no special scaffolding, ladders or lifting equipment other than that which is normally carried in a service vehicle is required, and that the conditions or working meet the requirements of local authorities having justification on conditions of work and safety.

A service fee may be charged to the customer if an aftersales service call is attended, and the fault is deemed to be a result of incorrect installation, or the points outlined below. Please note the site environment and associated product must be accessible and safe workplace for the service agent.

If applicable, Reece Australia will also provide information regarding how to claim back any expenses the consumer may incur.

## **Exclusions**

Except to the extent required by law, all consumer guarantees, representations, warranties, terms and conditions in relation to the products (whether implied or otherwise) are hereby excluded to the maximum extent permitted by law.

To the fullest extent permitted by law, Reece excludes all liability for damage or injury to any person, damage to any property, and any indirect consequential or other loss or damage.