

DUCTED AIR CONDITIONER

Wired Controller Manual

KD Series

KD24 | KD36 | KD42 | KD48 | KD60

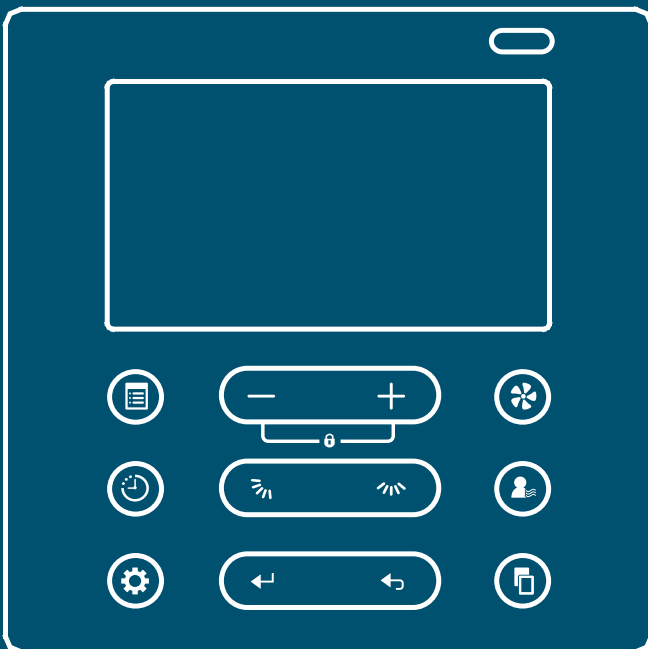

kaden°TM

Table of Contents

1. Safety Precautions	3
2. Installation Accessories	4
3. Installation Method	5
4. Specification	8
5. Features and Functions	9
6. Display Screen	10
7. Buttons	11
8. Operation	12
9. Timer Functions	14
10. Weekly Timer	15
11. Fault Alarms	18

Important note:

Read this manual carefully before installing or operating your new air conditioning unit. This manual gives detailed description of the precautions that should be followed during operation. Make sure to save this manual for future reference.

1. Safety Precautions

Read Safety Precautions Before Installation

Read the safety precautions carefully before installing the unit. Stated below are important safety issues that must be obeyed:



Means improper handling may lead to personal death or severe injury.





Means improper handling may lead to personal injury or property loss.

WARNING

- Please ensure a professional installs the unit.
- Installation by other persons may lead to incorrect installation, electric shock or fire. Adhere to this installation manual.

CAUTION

- Do not install the unit in a place vulnerable to leakage of flammable gases. Leaking flammable gases around the controller can result in fire.
- Do not operate with wet hands or let water enter the wired controller. Otherwise, electric shock may occur.
- The wiring should adapt to the wired controller current. Otherwise, electric leakage or over heating may occur and result in fire.
- The specified cables shall be used in the wiring. No external force should be applied to the terminal. This may result in damaged wiring and/or overheating which can create a fire hazard.

 WARNING	
<p>KEEP OUT OF REACH OF CHILDREN This product contains button / coin cell batteries. Keep new and used batteries away from children. A swallowed button or coin cell battery can cause internal chemical burns and death in as little as two hours. Dispose of unused batteries immediately. If you think batteries might have been swallowed or placed inside any part of the body, seek immediate medical attention.</p>	



'If it is suspected a button/coin battery has been swallowed or otherwise placed inside any part of the body, a person should contact the Australian Poisons Information Centre on 13 11 26 or National Poisons Centre on 0800 764 766 (New Zealand) immediately for 24/7 fast, expert advice.'



2. Installation Accessories

Select the installation location

Don't install in areas that contain oil, vapor or sulfureted gas, otherwise, this product can deform which could permanently damage the product.

Preparation before installation

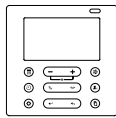
1. Please confirm that you have all the following parts.

No.	Name	Qty.	Remarks
1	Wired controller	1	
2	Wired controller manual	1	
3	Screws	3	M4X20 (for mounting on the wall)
4	Wall plugs	3	For mounting on the wall
5	Screws	2	M4X25 (for mounting on switch box)
6	Plastic screw bars	2	For fixing on switch box
7	The connective wires group-1	1	Optional
8	The connective wires group-2	1	Connect to mainboard
9	Battery 	1	

2. Prepare the following assemblies on the site.

No.	Name	Qty. (embedded into wall)
1	Switch box	1
2	Wiring tube (insulating sleeve and tightening screw)	1

Precautions

1. This manual explains the installation requirements for the wired controller. Please refer to the wiring diagram of this installation manual to wire the wired controller to the indoor unit.
2. The wired controller operates in a low voltage loop circuit. Do not directly contact the cable of 220V commercial electricity or of 380V high voltage, and don't wire this kind of wire in the loop; wiring clearance between configured tubes should be at the range of 300~500 or above.
3. The shielded wire of the wired controller must be grounded reliably.
4. Upon completing the wired controller connection, do not use a mega to detect the insulation.
5. The connective cable of the wired controller should not be longer than 20 meters.

3. Installation Method

1. Wired controller size

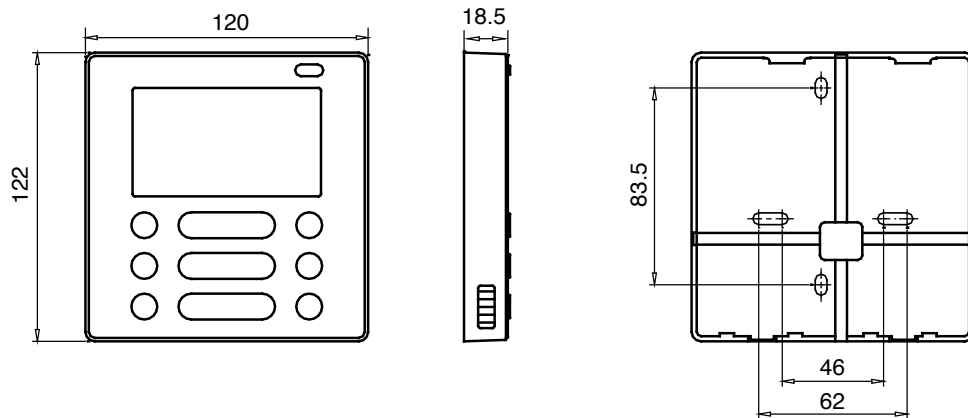

2. Wiring principle sketch

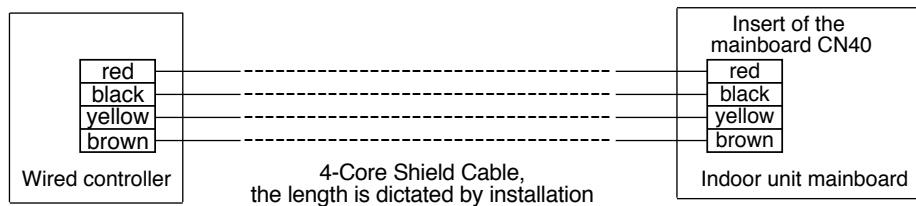

3. Wiring figure

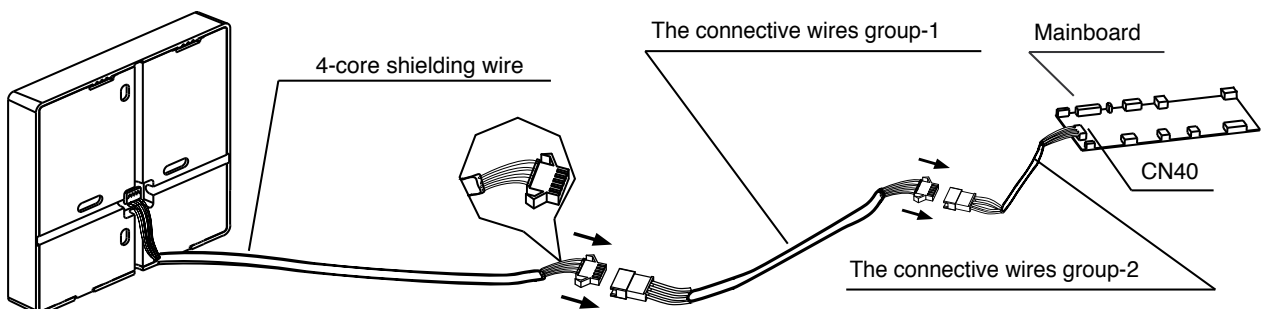

- Connect the female joint of wires group from the mainboard with the male joint of connective wires group.
- Please connect the other side of connective wires group with the male joint of wires group leads from the wired controller.

4. Remove the upper part of the wired controller

Insert a slotted screwdriver into the slots in the lower part of the wired controller (2 places), and remove the upper part of the wired controller.

NOTICE

The PCB is mounted in the upper part of the wired controller. Be careful not to damage the board with the slotted screwdriver.

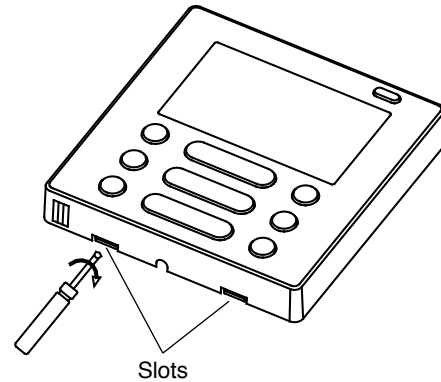

5. Fasten the back plate of the wired controller

For exposed mounting, fasten the back plate on the wall with the 3 screws (M4×20) and plugs.

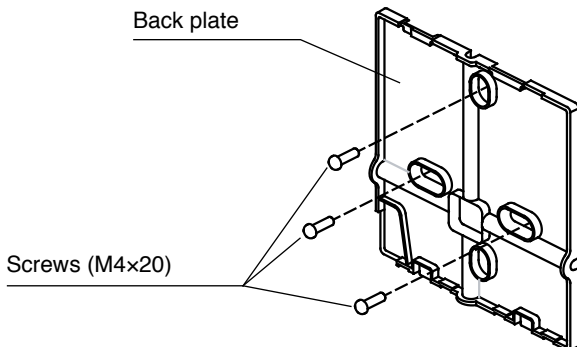

For flush-mounting, fasten the back plate on the switch box with 2 screws (M4×25) and fasten it on the wall with 1 screw (M4×20).

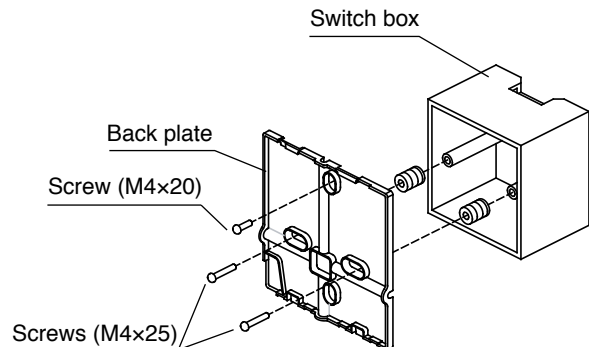

NOTICE

Put on a flat surface. Be careful not to distort the back plate of the wired controller by overtightening the mounting screws.

6. Battery installation

- Put the battery into the installation site and make sure the positive side of the battery is in accordance with the positive side of installation site. (See figure opposite.)
- Please set the time during first operation. Batteries in the wired controller can fail during a power failure. When power is restored, if the time displayed is not correct, it means the battery is dead and requires replacing.

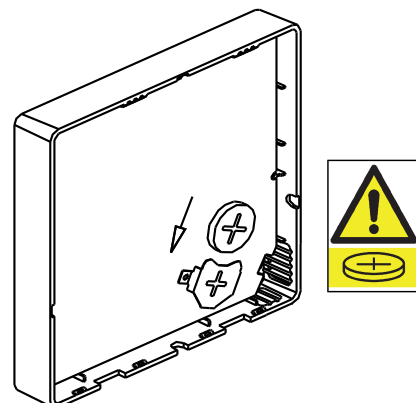

7. Wiring

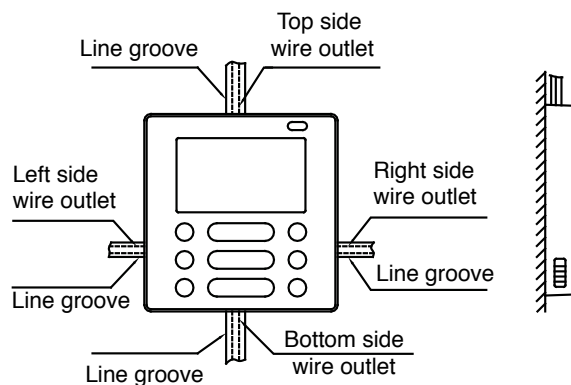

A. In regards to wiring outlets, there are four options. Three need cutting.

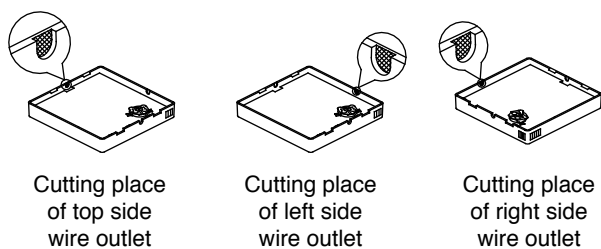

! CAUTION

- Avoid water ingress into the wired controller, use trap and putty to seal the connectors of wires during wiring installation.
- During installation, leave some length of the connecting wires for convenient maintenance, when the controller needs to be removed from its location.

B. Shielded wiring

Embedded switch box wiring

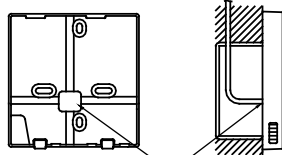

Wiring hole

Wiring through the wall

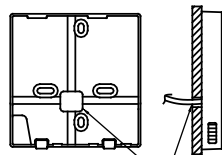

Wall hole and wiring hole diameter of wall hole: $\Phi 20\text{mm}$

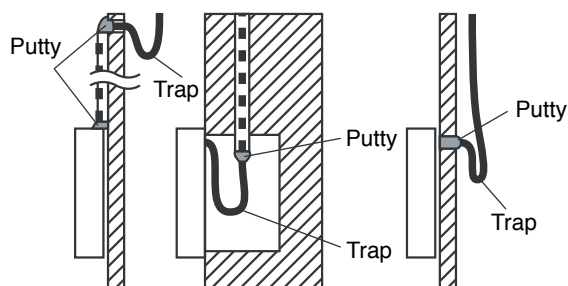

8. Reattach the upper part of the wired controller

After adjusting the upper case click it into place; avoid clamping the wiring during this process.

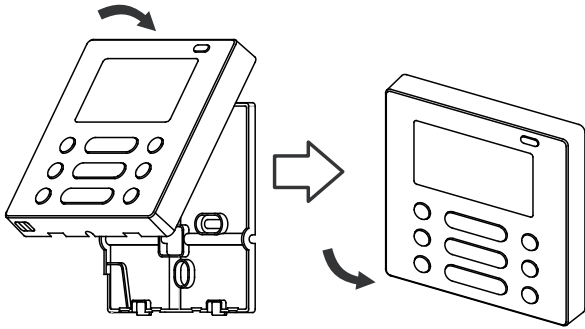

Note

All the pictures in this manual are for explanation purpose only.

Your wired controller may be slightly different. In this case the actual shape shall prevail.

4. Specification

Input voltage	Ambient temperature	Ambient humidity
DC 5V/DC 12V	-5~43°C	RH40%~RH90%

5. Features and Functions

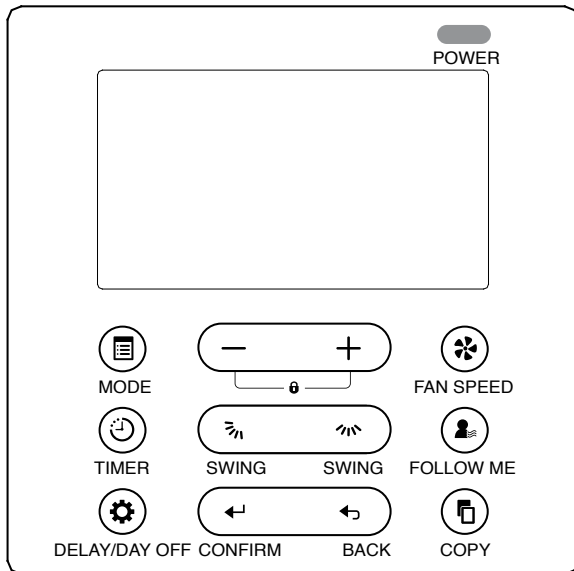

Features

- LCD display.
- Malfunction code display: Displays error codes.
- 4-way wire layout design, no raised part at back, more convenient to place the wires and install the device.
- Room temperature display.
- Weekly Timer.

Function

- Mode: Auto – Cool – Dry – Heat – Fan
- Fan speed: Auto/Low/Med/High
- Timer ON/OFF
- Temp setting
- Weekly timer
- Follow me
- Child lock
- LCD display
- Clock
- Infrared remote receiver (on some models)

6. Display Screen

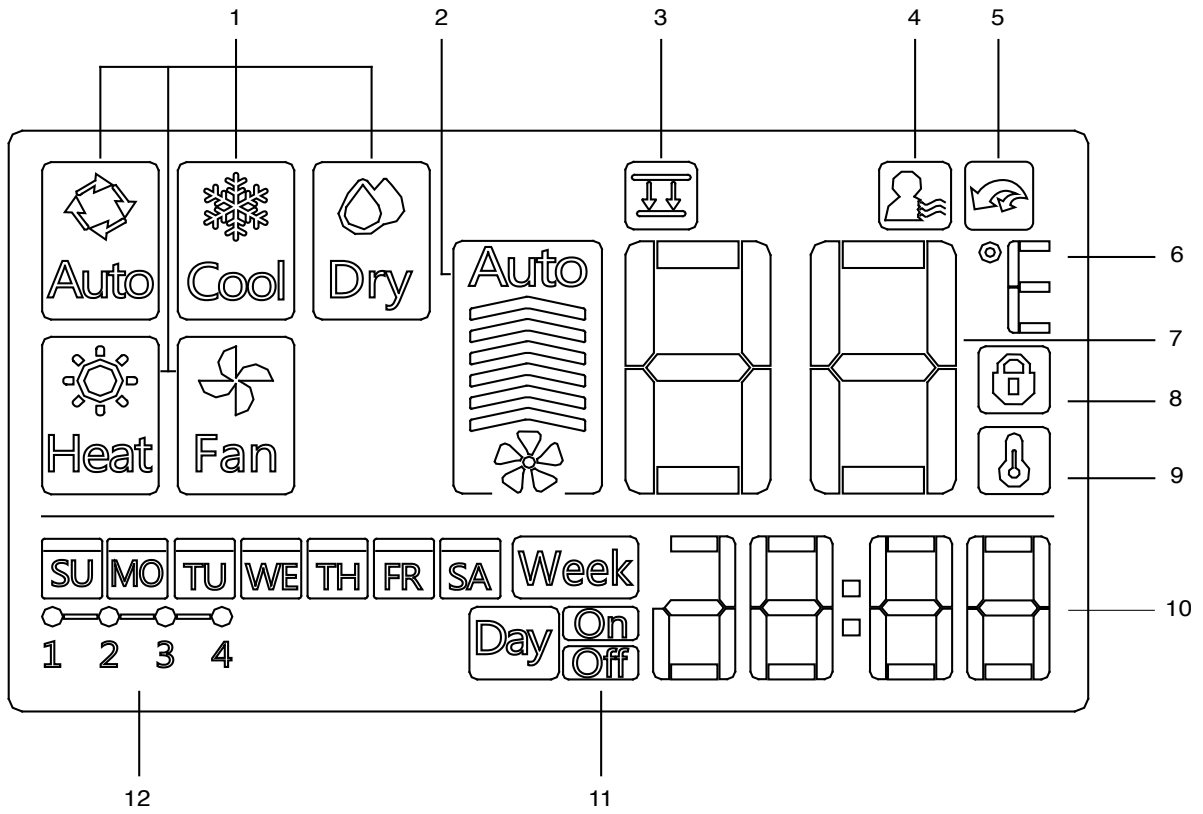

- | | |
|-----------------------|------------------------|
| 1. Operation mode | 7. Temperature display |
| 2. Fan speed | 8. Lock |
| 3. Faceplate function | 9. Room temperature |
| 4. Follow me function | 10. Clock display |
| 5. Turbo mode | 11. On/Off timer |
| 6. °C / °F | 12. Timer display |

7. Buttons

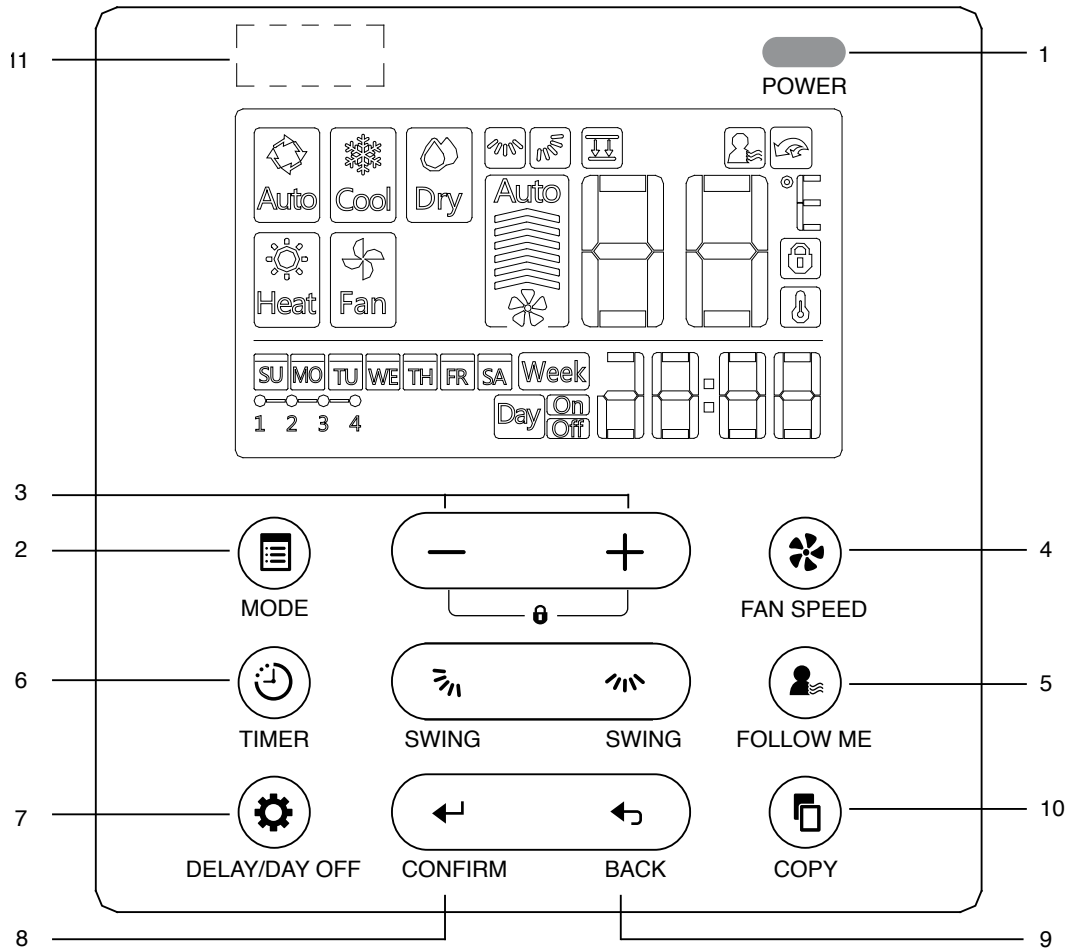

- | | |
|-------------------------|---|
| 1. POWER | 7. DELAY/DAY OFF |
| 2. MODE | 8. CONFIRM |
| 3. Adjust | 9. BACK |
| 4. FAN SPEED | 10. COPY |
| 5. FOLLOW ME/TURBO MODE | 11. Infrared remote receiver (on some models) |
| 6. TIMER | |

8. Operation

Set the current day and time

1. Press the TIMER button for 3 seconds or more. The timer display will flash.



2. Press the button "+" or "-" to set the day. The selected day will flash.

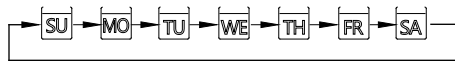

3. The day setting is finished and the time setting is ready to set after pressing TIMER button or if you don't press a button in 10 seconds.



4. Press the button "+" or "-" to set the current time. Press repeatedly to adjust the current time in 1-minute increments. Press and hold to adjust the current time quickly.



ex. Monday AM 11:20

5. The setting is done after pressing TIMER button or if you don't press a button in 10 seconds.



Remote signal receiving function

The wired controller can be a remote signal receiving device, you can use the wireless remote controller to control the air-conditioner through the wired remote controller when the system has been powered on.

To start/stop operation



Press the POWER button.

Operation lamp
Air conditioner ON: Lit brightly
Air conditioner OFF: Not lit

To set the operation mode

Mode setting

Press the MODE button to set the mode.

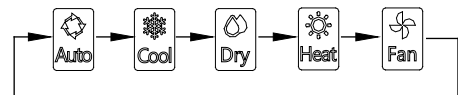

Room temperature

Press the button "+" or "-" to set the room temperature. Indoor Setting Temperature Range: 17~30°C

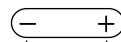

Lower Higher

Fan speed setting

Press the FAN SPEED button to set the fan speed. (This button does not work when in Auto or Dry mode.)

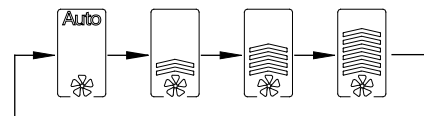

Room temperature sensor selection

Press the FOLLOW ME button to select whether the room temperature is detected at the indoor unit or the wired controller.

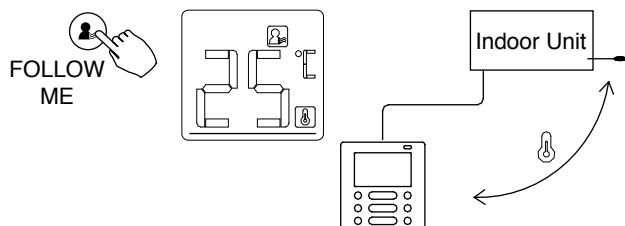

When the Follow Me function indicator appears , the room temperature is detected at the wired controller.

Turbo Mode

Press and hold the FOLLOW ME button for 5 or more seconds. The unit will enter TURBO MODE. Please note that TURBO MODE does not work in heating mode.



When TURBO MODE is activated the  icon mark appears.

Child lock function

Press the button “+” and “-” simultaneously for 3 seconds to activate the child lock function and lock all buttons on the wired controller. Press the buttons again for 3 seconds to deactivate the child lock function.

When the child lock function is activated, the  icon mark appears.

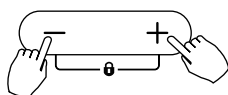



Keypad tone setting

Press the button “BACK” and “COPY” simultaneously for 3 seconds to close the keypad tone.

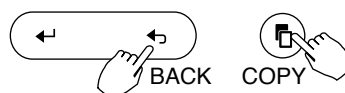
Press the buttons again for 3 seconds to open the keypad tone.



°C & °F scale selection (on some models)

Press and hold  and  buttons together for 3 seconds, this will alternate the temperature display between °C and °F.

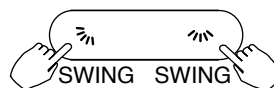

Left-Right swing

Pressing the  button will not do anything. This button is irrelevant for your air-conditioner.

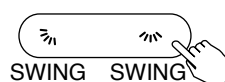

Up-Down airflow direction and swing

Pressing the  button will not do anything. This button is irrelevant for your air-conditioner.

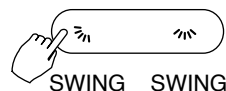

9. Timer Functions

Week

WEEKLY timer

Use this timer function to set operating times for each day of the week.

Day On

On timer

Use this timer function to start air conditioner operation. The timer operates and air conditioner operation starts after the time has passed.

Day Off

Off timer

Use this timer function to stop air conditioner operation. The timer operates and air conditioner operation stops after the time has passed.

Day On Off

On and Off timer

Use this timer function to start and stop air conditioner operation. The timer operates and air conditioner operation starts and stops after the time has passed.

To set the On or Off TIMER

1. Press the TIMER button to select the **Day On** or **Day Off**.



TIMER

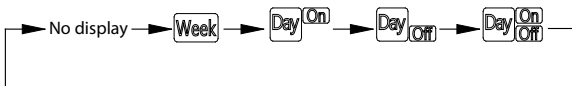

2. Press the CONFIRM button and the Clock display will flash.

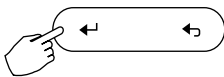

CONFIRM

3. Press the button "+" or "-" to set the time. After the time is set, the timer will start or stop automatically.

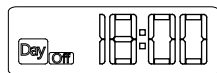

ex. Off timer set at 6:00PM

4. Press the CONFIRM button again to finish.

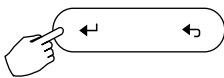

CONFIRM

To set the On and Off TIMER

1. Press the TIMER button to select the **Day On** or **Day Off** button.



TIMER

2. Press the CONFIRM button and the Clock display will flash.

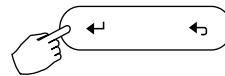

CONFIRM

3. Press the button "+" or "-" to set the time of On timer, and then press the CONFIRM button to confirm.



CONFIRM

4. Press the button "+" or "-" to set the time of Off timer.



5. Press the CONFIRM button to finish.

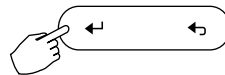

CONFIRM

10. Weekly Timer

1. Weekly timer setting

Press the TIMER button to select the **Week** button and then press the CONFIRM button to confirm.

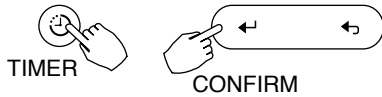

2. Day of the week setting

Press the button “+” or “-” to select the day of the week and then press the CONFIRM button to confirm the setting.

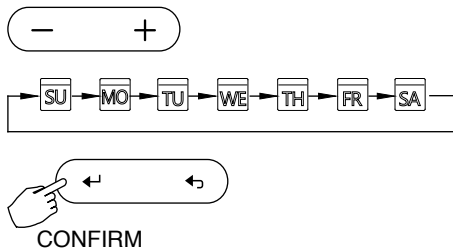

3. ON timer setting of timer setting 1

Press the button “+” or “-” to set the time of On timer and then press the CONFIRM button to confirm the setting.

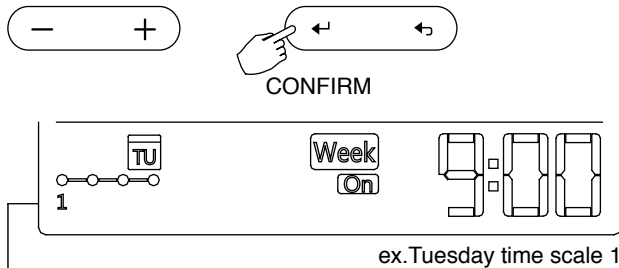

Up to 4 timer settings can be saved for each day of the week. It is convenient if the WEEKLY TIMER is set according to the user's life style.

4. Off timer setting of timer setting 1

Press the button “+” or “-” to set the time of Off timer and then press the Confirm button to confirm the setting.

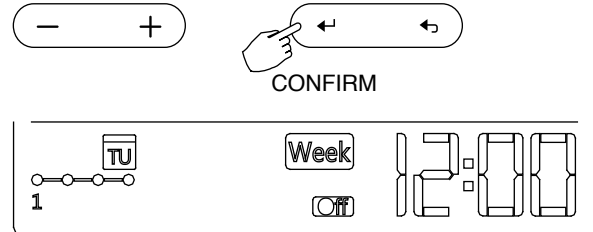

5. Different timer settings can be set by repeating steps 3 to 4.

6. Other days in one week can be set by repeating steps 2 to 5.

Note

- In the weekly timer setting you can return to the previous step by pressing the BACK button.
- The time of the timer setting can be deleted by pressing the DAY OFF button
- The current setting will be restored and withdrawn automatically when there is no operation for 30 seconds.

WEEKLY timer operation

To activate WEEKLY TIMER function

Press the TIMER button while **Week** is displayed on the LCD screen.



TIMER

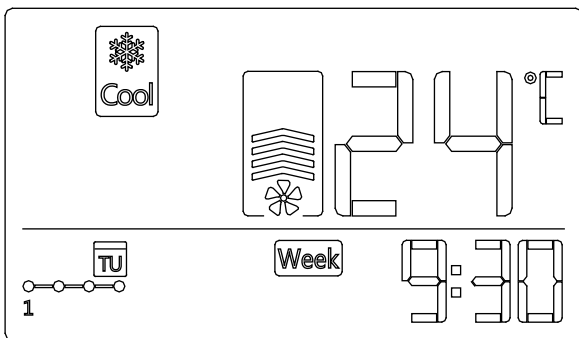

To deactivate WEEKLY TIMER function

Press the TIMER button while **Week** disappears from the LCD screen.

To turn off the air conditioner during the weekly timer

1. If you press the POWER button once and quickly, the air conditioner will turn off temporarily. And the air conditioner will turn on automatically until the time of On timer.

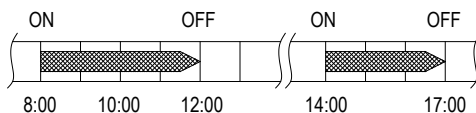

Example: If you press the POWER button once and quickly at 10:00, the air conditioner will turn on at 14:00.

2. When you press the POWER button for 2 seconds, the air conditioner will turn off completely.

To set the DAY OFF (for a holiday)

1. During the weekly timer, press the CONFIRM button.

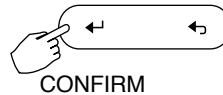

CONFIRM

2. Press the button "+" or "-" to select the day in the week.



3. Press the DAY OFF button to set the DAY OFF.



DELAY/DAY OFF

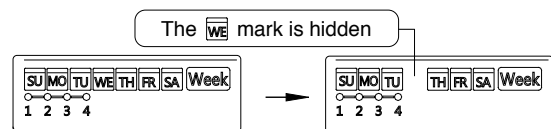

ex. The DAY OFF is set for Wednesday

4. The DAY OFF can be set for other days by repeating steps 2 and 3.
5. Press the BACK button to go back to the weekly timer.



BACK

Note

- To cancel: Follow the same procedures as those for setup.
- The DAY OFF setting is cancelled automatically after the set day has passed.

DELAY function

During the weekly timer, pressing the DELAY button once, displays 0h.

Pressing this button twice, displays 1h and wait 3 seconds to confirm. It means the unit will override 1 hours.

Pressing this button three times, displays 2h and wait 3 seconds to confirm. It means the unit will override 2 hours.



DELAY/DAY OFF

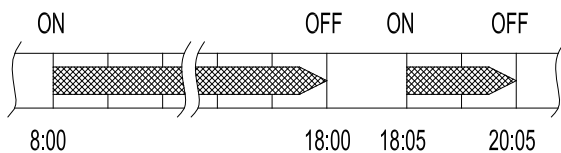
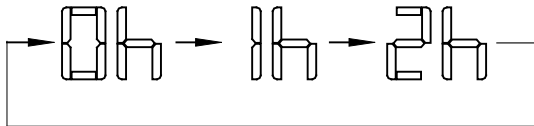

Example: If you press the DELAY button to select 2h at 18:05, the air conditioner will delay to turn off to 20:05.

Copy the setting from one day to another day.

A timer made once can be copied to another day of the week. The setting of the selected day of the week will be copied. The effective use of the copy mode ensures ease of making other timer settings.

1. During weekly timer, press the CONFIRM button.

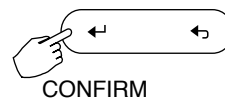

2. Press the button "+" or "-" to select the day to copy from.



3. Press the COPY button, the letters "CY" will be shown on the LCD screen.



4. Press the button "+" or "-" to select the day to copy to.



5. Press the COPY button to confirm.



The **WE** mark flashes quickly

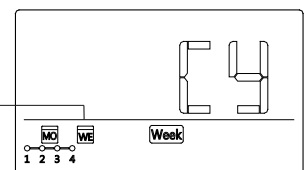

Example: Copied the setting of Monday to Wednesday

6. Other days can be copied by repeating steps 4 and 5.
7. Press the Confirm button to confirm the settings.

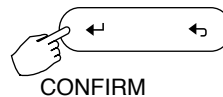

8. Press the Back button to go back to the weekly timer.



11. Fault Alarms

If the system does not properly operate, investigate according to the following procedures.

No.	Malfunction & Protection Define	Display Digital Tube
1	Error of communication between wired controller and indoor unit	F0
2	The faceplate is abnormal	F1

Please check the error display of the indoor unit and read the unit owners manual if other error codes appear.

Notes

kaden^o_{TM}

kadenair.com.au