

HRT/6-630/30 BPN

IP54



Dimensiones y conexiones
Dimensions and wiring

Características Characteristics

Tensión Voltage	3 ~ 400V 50Hz
Tipo motor Motor type	6 polos 6 poles IP54 cl.F
Potencia absorbida máxima Maximum power absorbed	0,69/0,48 kW
Intensidad absorbida máxima Maximum absorbed current	1,4/0,8 A
Condensador Capacitor	
Ia/In Is/In	3,0
Temperatura del aire Air temperature	-40°C < T < +70°C
Peso Weight	17,2 kg
Código ventilador Fan code number	5700155400
Código motor Motor code number	0342652005

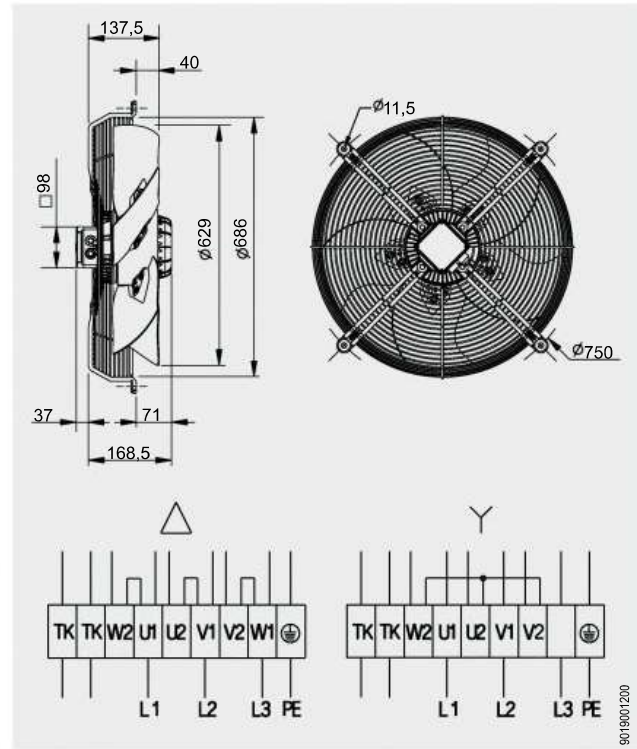

Curvas características / Performance curves (04/04/2012)

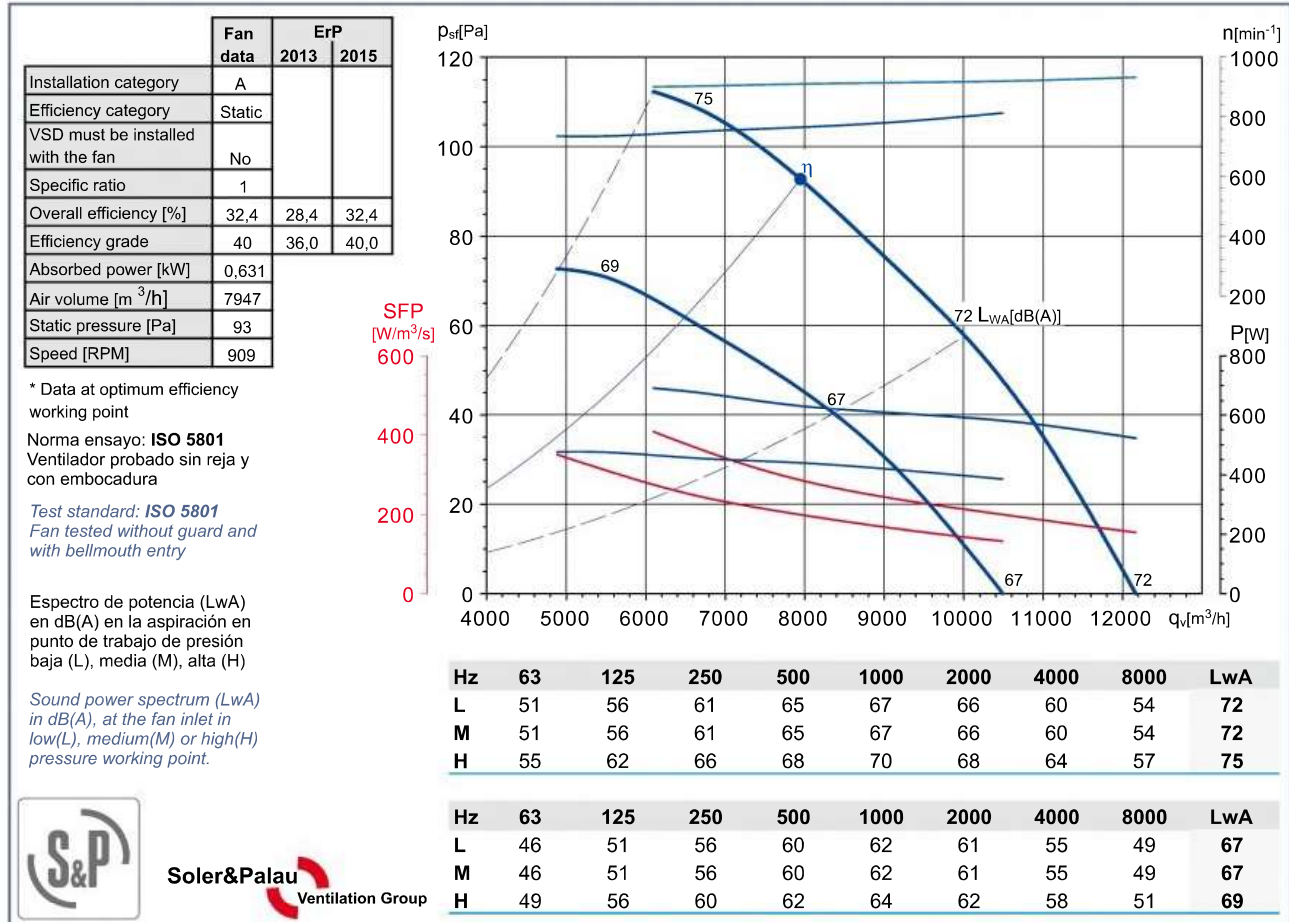

Soler&Palau
Ventilation Group