

Instructions for Use and Installation

52cm Black Glass Undermount Rangehood
TGU52BK



90cm Black Glass Undermount Rangehood
TGU90BK





Contents

For Your Safety

Safety Precautions	3
Before Connecting	3
Warnings	4

Use and Care

Use and Care	6
Controls	6
Cleaning your Rangehood	7
Troubleshooting	8
Disposal	8

Installation

Electrical Connection	9
Instructions for Installation	10
Dimensions.	11
Cutout Dimensions	12
Fixing the Rangehood	13



For Your Safety

Carefully read the following important information regarding installation safety and maintenance. Keep this information booklet accessible for future reference.

The appliance has been designed for use in a Ducted installation.

Safety Precautions

Take care when the Range Hood is operating simultaneously with an open fireplace or burner that depend on natural ventilation as the Range Hood removes air from the room, which a burner or fireplace may need for combustion.

Provide adequate ventilation for safe operation of the Range Hood. Follow any local laws that apply to external air evacuation.

Before connecting to the electricity network:

Look at the data plate (located inside the appliance) to ascertain that the voltage and power correspond to the available power supply and the power outlet is suitable. If in doubt ask a qualified electrician.

If the appliance is used intensively for a long period of time, you may need to opening a window to improve airflow.



For Your Safety



WARNINGS!

- Do not check the status of the filters while the Range Hood is operating.
- Do not touch bulbs or adjacent areas, during or straight after use.
- **CAUTION:** Accessible parts may become hot when used with cooking appliances.
- Do not flambé under the Range Hood.
- Avoid free flame, as it is damaging to the filters and can cause fire hazard.
- Constantly check food frying, overheated oil may become a fire hazard.
- Disconnect the electrical plug prior to any maintenance.
- This appliance is not intended for use by persons (including children) with reduced physical, sensory or mental capabilities, or lack of experience and knowledge, unless they have been given supervision or instruction concerning use of the appliance by a person responsible for their safety.
- Children should be supervised to ensure that they do not play with the appliance.
- There shall be adequate ventilation in the room when the Range Hood is used at the same time as appliances burning gas or other fuels.
- There is a fire risk if cleaning is not carried out in accordance with the instructions.
- **WARNING:** DO NOT penetrate any screws into the range hood as this may result in electrical hazards.
- **WARNING:** Failure to install the screws or fixing device in accordance with these instructions may result in electrical hazards.



For Your Safety



WARNINGS!

- If the supply cord is damaged, it must be replaced by the manufacturer, its service agent or similarly qualified persons in order to avoid a hazard.
- The air must not be discharged into a flue that is used for exhausting fumes from appliances burning gas or other fuels.
- The minimum distance between the cooktop hob and the lowest part of the range hood shall be at least 60cm. If the instructions for installation of the gas hob specify a greater distance, this has to be taken into account.
- Regulation concerning the discharge of air has to be fulfilled.

THE MANUFACTURER DECLINES ALL RESPONSIBILITY FOR DAMAGES CAUSED BY BREACHING THE ABOVE WARNINGS.



Use and Care

It is recommended to start the Range Hood prior to commencing to cook and leave the Range Hood in operation for 15 minutes after cooking is finished in order to completely eliminate cooking vapours and odours.



To ensure the Range Hood continues to operate effectively, regular maintenance and cleaning is required. Clean the fan and other surfaces of the Range Hood regularly using a cloth moistened with warm water or non abrasive liquid detergent.

LED Touch Control



How to use the control panel:

Press the  key. The lights will turn on and the fan will start on speed 1.



Use the  or  keys to adjust the fan speed which is shown on the display (i.e. 1, 2 or 3)

Press the  key to turn the light on/off.

Press the  key to turn the rangehood off.

Or

Press the  key. The lights will remain off and the fan will start on speed 1.

Use the  or  keys to adjust the fan speed which is shown on the display (i.e. 1, 2 or 3)

Press the  key to turn the light on/off.

Press the  key to turn the rangehood off.

Lights

The lights can be operated with the  key even when the rangehood is off.

Timer

Press the  key when the fan is operating. The default timer setting is 5mins. When the time is up, the rangehood fan and lights will turn off automatically.

Press the  key again to cancel the timer.



Use and Care

Cleaning your rangehood

The proper function of the rangehood requires regular maintenance operations.

The anti-grease filters capture the grease particles suspended in the air, and are therefore subject to clogging according to the frequency of the use of the appliance.

In order to prevent fire hazard, it is recommendable to clean the filter at a minimum of every 2 months by carrying out the following instructions:

- Remove the filters from the cooker hood and wash them in a solution of water and neutral liquid detergent, leaving to soak.
- Rinse thoroughly with warm water and leave to dry.
- The filters may also be washed in the dishwasher.

The aluminum panels may alter in color after several washes. This is not cause for customer complaint nor replacement of panels.

Clean the fan and other surfaces of the cooker hood regularly using a cloth moistened with denatured alcohol or non abrasive liquid detergent.

Keep motor and other parts free from water as this will cause damage to the appliance.

Removing the anti grease filters:

1. Open the hinged glass panel
2. Slide the plastic filter handle inwards and pull the filter down.

To refit the filters

1. Angle the tabs on the filter into slots at one end.
2. Slide plastic filter handle inwards and push the filter into place.
3. Close the hinged glass panel.

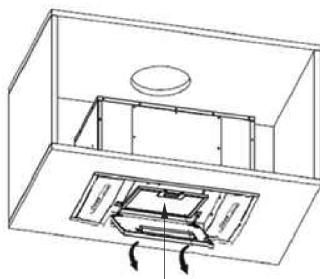

Aluminium Filter

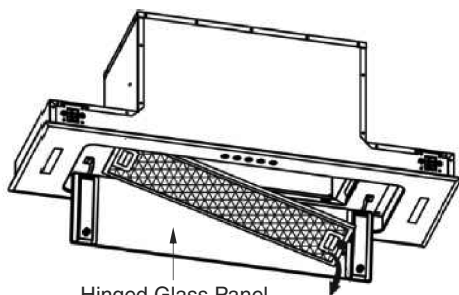

Hinged Glass Panel



Use and Care

Troubleshooting

Problem	Possible reason	Solution
Hood doesn't work	No electricity supply	Check the plug is connected
		Check that the main switch/circuit breaker/safety switch is turned on
Poor airflow	Aluminum grease filters clogged	Clean the filters and replace when dry
Motor running but no air flow	Butterfly valve jammed	Contact service department
Motor turns off after a few minutes	High temperature safety device activated	The kitchen is not sufficiently ventilated
	The hood is installed too near to the cooktop	The hood must be at least 600mm from the top of the cooktop
Oil dripping onto stove	Aluminum grease filter saturated	Wash the aluminum grease filters
Whirring sound	Something in contact with fan blade	Contact service department

Disposal



By ensuring this product is disposed of correctly, you will help prevent potential negative consequences for the environment and human health, which could otherwise be caused by inappropriate waste handling of this product.

The symbol on the product indicates that this product may not be treated as household waste. Instead it shall be handed over to the applicable collection point for the recycling of electrical and electronic equipment.

Disposal must be carried out in accordance with local environmental regulations for waste disposal.

For more detailed information about treatment, recovery and recycling of this product, please contact your local city council office.



Installation

Assembly and electrical connections must be carried out by authorised personnel.

Electrical Connection

The Range Hood is fitted with a power cord and 3 pin plug. Install the Range Hood so that the plug is easily accessible. Plug the 3-pin plug into a properly earthed, 10A general purpose power outlet.

If the supply cord is damaged, it must be replaced by the manufacturer or its service agent or a similarly qualified person in order to avoid a hazard.

The appliance has been manufactured as a class I, therefore earth cable is necessary.

The connection to the mains is carried out as follow:

	IEC227	North America
L = Live	Brown	Black
N = Neutral	Blue	White
E = Earth	Green/Yellow	Green

If not provided, connect a plug for the electrical load indicated on the description label. Where a plug is provided, the cooker hood must be installed so that the plug is easily accessible after installation.

An omnipolar switch with a minimum aperture of 3mm between contacts, in line with the electrical load and local standards, must be placed between the appliance and the network in the case of direct connection to the electrical network.



Installation

Instructions for Installation

Install Range Hoods in accordance with the manufacturer's instructions. For optimum performance, Technika recommends that all Range Hood clearances be a minimum of 650mm to a maximum of 750mm between the top of the cooking surface to the underside of the Range Hood. The distance may be reduced to 600mm to align with AS/NZS 5601.

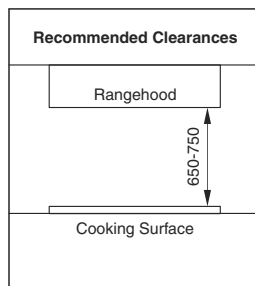

WARNING: DO NOT penetrate any screws into the range hood as this may result in electrical hazards.

WARNING: Failure to install the screws or fixing device in accordance with these instructions may result in electrical hazards.

If a connection flue composed of two parts is used, the upper part must be placed outside the lower part.

Exhaust air must not be discharged into a flue which is used for exhausting fumes from appliances burning gas or other fuels. Installation must comply with any local regulations concerning the discharge of exhaust air.

Before proceeding with the assembly, prepare the hole in the ceiling or wall for the evacuation of the air.



Installation

Dimensions

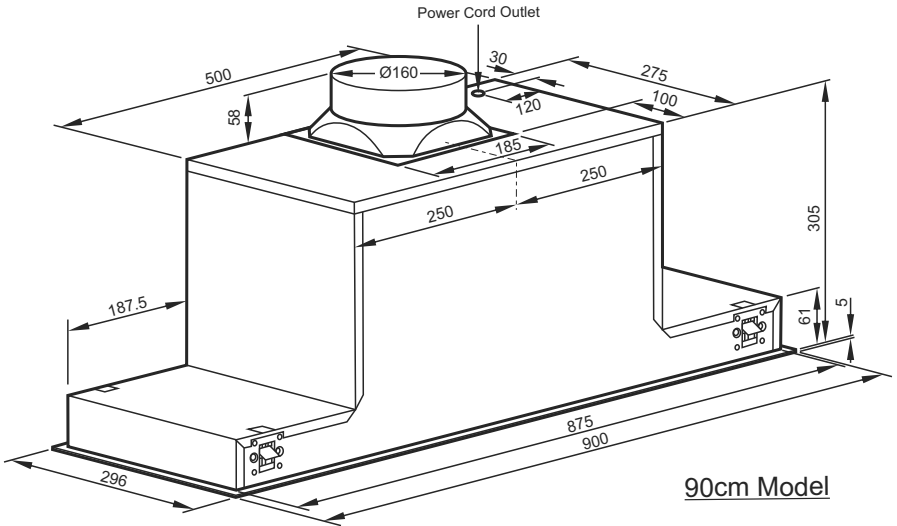
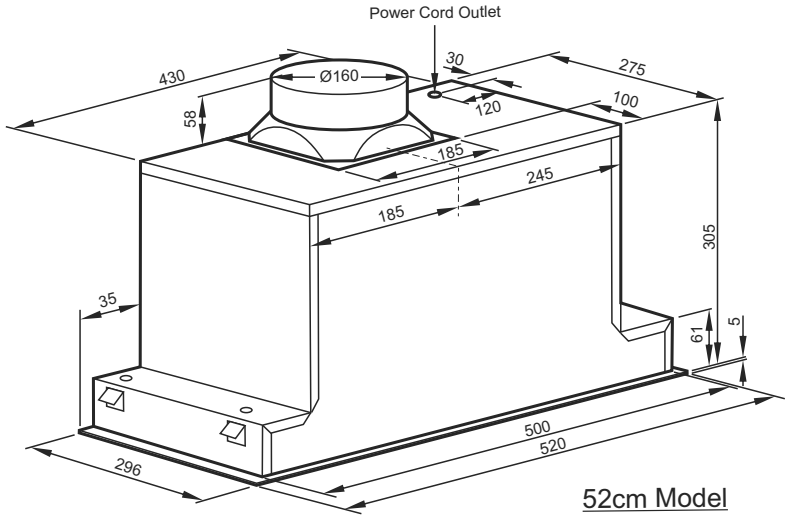



Installation

Cutout Dimensions

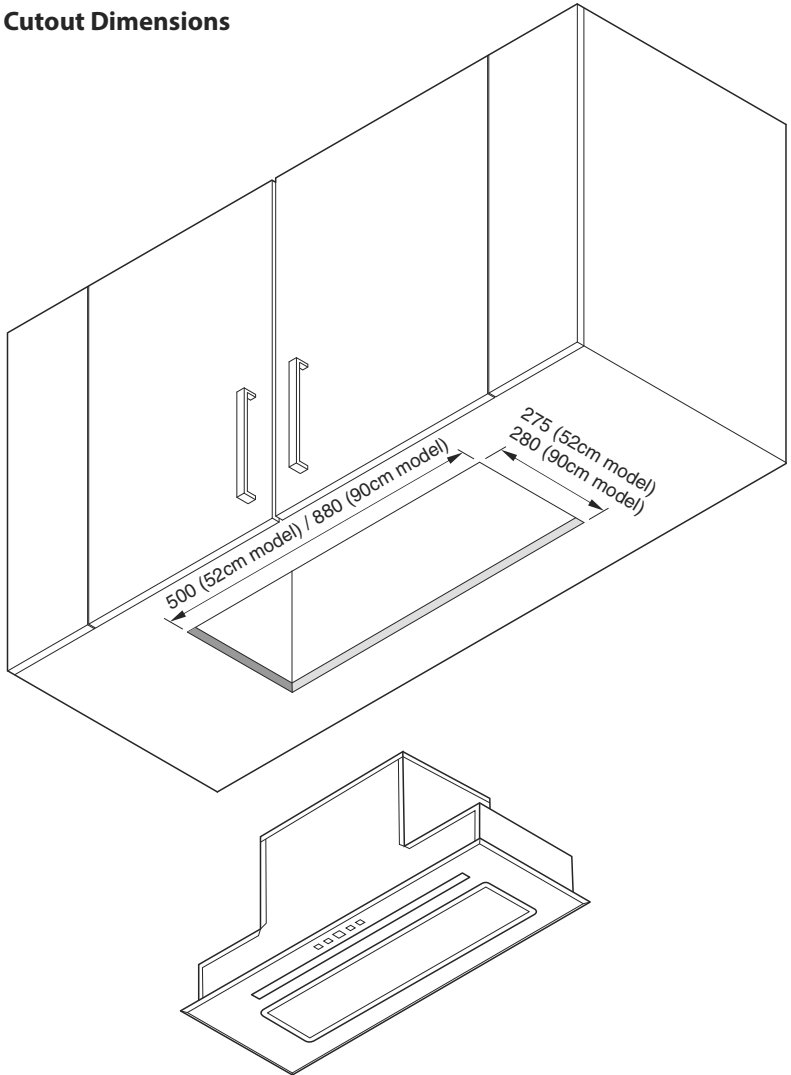



Installation

Fixing the Rangehood

1. Adjust the 4 spring clips to the highest level by turning the screws clockwise.
2. Push the hood up into the cabinet ensuring the 4 spring clips spring out.
3. Tighten the 4 spring clips by turning the screws anti-clockwise until the hood is raised up and secure.

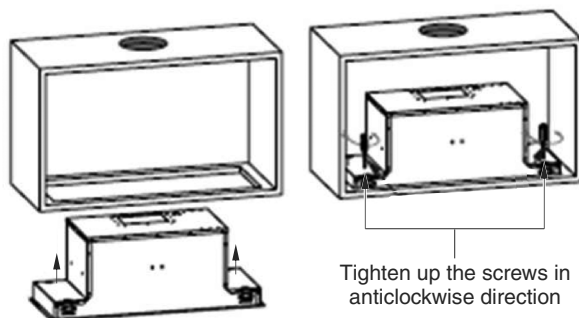





READ THE INSTRUCTION BOOKLET BEFORE INSTALLING AND USING THE APPLIANCE.

The manufacturer will not be responsible for any damage to property or to persons caused by incorrect installation or improper use of the appliance.

The manufacturer is not responsible for any inaccuracies, due to printing or transcription errors, contained in this handout. In addition, the appearance of the figures reported is also purely indicative.

The manufacturer reserves the right to make changes to its products when considered necessary and useful, without affecting the essential safety and operating characteristics.

Technika constantly seeks ways to improve the specifications and designs of their products.

Whilst every effort is made to produce up to date literature, this document should not be regarded as an infallible guide.

Actual product only should be used to derive cut out sizes.

All Technika Appliances must be installed by a qualified person/s with adherence to the relevant electrical, plumbing and gas codes, with compliance being issued as required by state or national legislation.

Additionally all Technika Upright cookers must have chains installed correctly in adherence to the relevant gas and plumbing codes by a Licenced installer.

For maximum effectiveness and efficiency all rangehoods should be installed with the use of ductwork, by a licenced installer with adherence to the relevant state and national building codes and regulations.

All Technika appliances are for Domestic use only, and must be installed by a licenced installer into Domestic Applications only, without exception and to the required Authorities guidelines. Any installation outside of this will VOID warranty. Alfresco areas are not a Domestic application.



TECHNIKA PTY LTD ACN 069 686 326
77 FILLO DRIVE SOMERTON VIC 3062
General : 1800 649 969 - Service : 1800 333 244

Technika After Sales Service - P.O. Box 543 SOMERTON VIC 3061

Version 1 Revision 20190625