

AXA CENTO BASINS

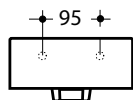

Cento Mini Counter/Wall Basin 250 x 450mm (Rear) - 1 Taphole

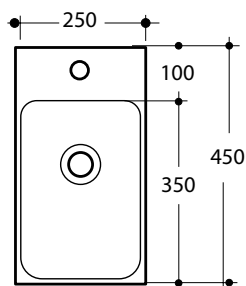
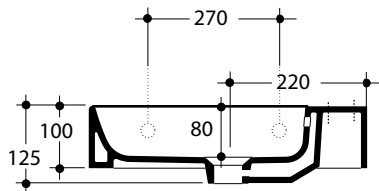
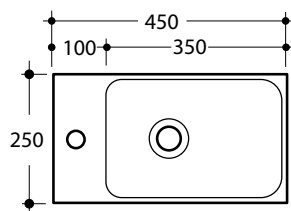

Cento Mini Counter/Wall Basin 450 x 250mm - 1 Taphole

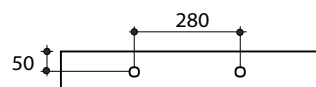
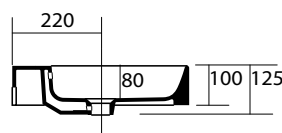
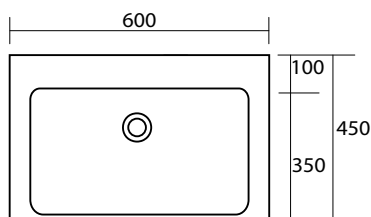

Cento Counter/Wall Basin 600 x 450mm - 0 Taphole

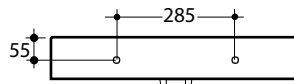
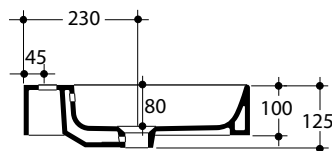
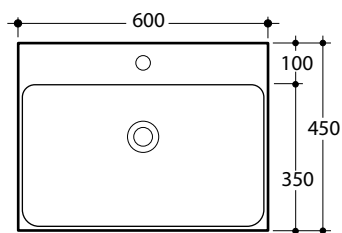

Cento Counter/Wall Basin 600 x 450mm - 1 Taphole

Dimensions are nominal measurements only.

To see the complete Axa range go to www.reece.com.au/bathrooms

Disclaimer: Products in this specification manual must by regulation be installed by licensed and registered trade people. The manufacturer/distributor reserves the right to vary specifications or delete models from their range without prior notification. Dimensions are nominal measurements only. Dimensions and set-outs listed are correct at time of publication however the manufacturer/distributor takes no responsibility for printing errors.

Tech Page Version 2



AXA CENTO BASINS

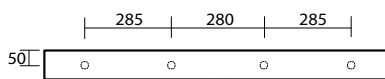
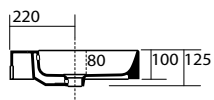
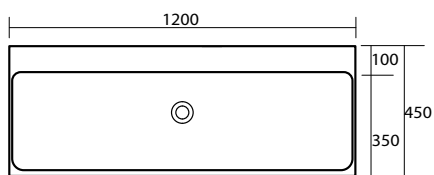

Cento Counter/Wall Basin 1200 x 450mm - 0 Taphole

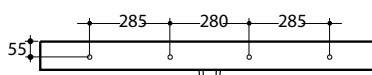
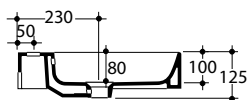
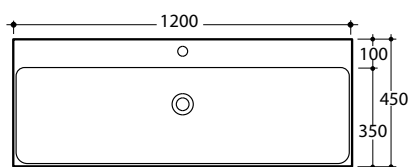

Cento Counter/Wall Basin 1200 x 450mm - 1 Taphole

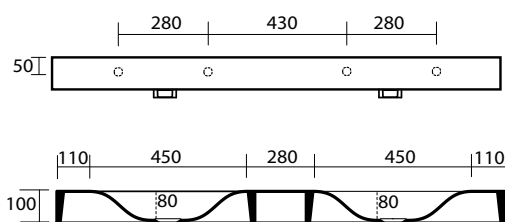
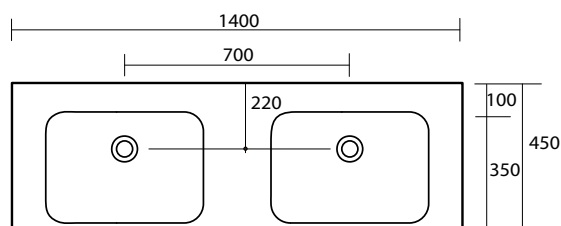

Cento Counter/Wall Basin 1400 x 450mm - 0 Taphole

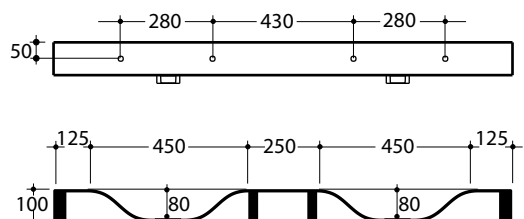
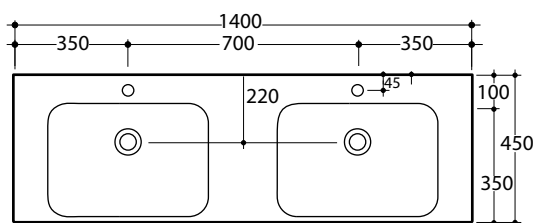

Cento Counter/Wall Basin 1400 x 450mm - 1 Taphole

Dimensions are nominal measurements only.

Plumbers, please ensure a copy of the installation instructions is left with the end user for future reference

AXA

CENTO BASINS

SPECIFICATIONS	
Recommended use	Domestic, hotel and commercial
Material	Ceramic
Colour	White
Integral overflow	Yes
Overflow Dress Ring	Yes. (Chrome only)
Taphole availability	250 x 450mm - 1 Taphole 450 x 250mm - 1 Taphole (Left and Right Hand Option) 600 x 450mm - 0 Taphole or 1 Taphole 1200 x 450mm - 0 Taphole or 1 Taphole 1400 x 450mm - 0 Taphole or 1 Taphole
Capacity	250 x 450mm - 2L 450 x 250mm - 2L 600 x 450mm - 4.5L 1200 x 450mm - 12L 1400 x 450mm - 4L (Per Basin)
Weight	250 x 450mm - 7kg 450 x 250mm - 7kg 600 x 450mm - 15kg 1200 x 450mm - 26kg 1400 x 450mm - 31kg
Plug and waste	32x40 Overflow Waste (Not supplied)
Mounting	Wall fixing kit supplied

CLEANING RECOMMENDATIONS

We recommend the use of soapy water or approved cleaners.

This product should not be cleaned with abrasive materials.

Damage caused by any improper treatment is not covered by the product warranty - refer to Warranty Conditions.

AXA CENTO BASINS

INSTALLATION INSTRUCTIONS

Wall

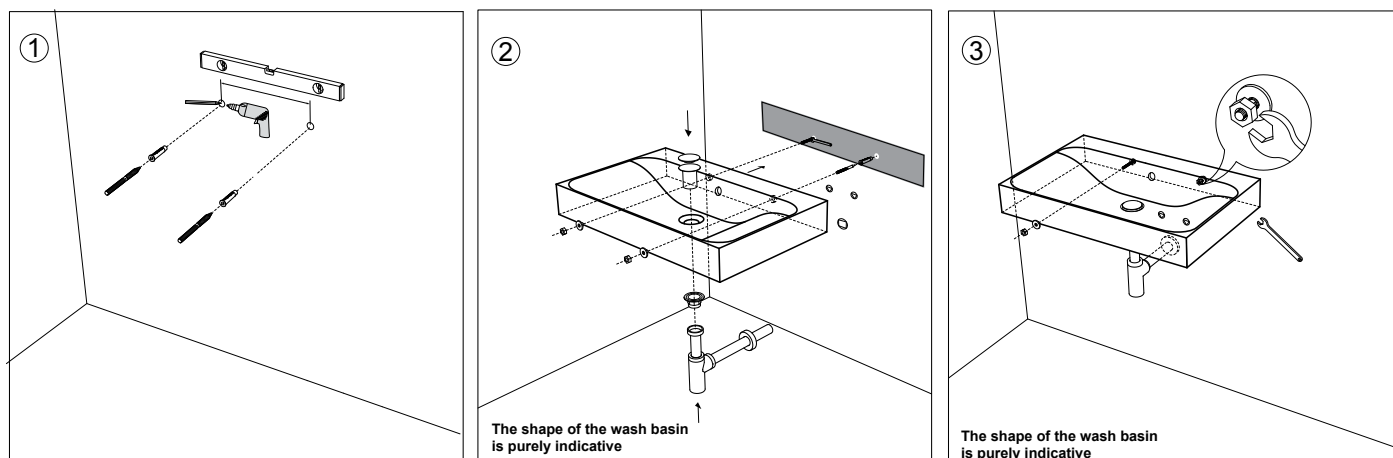

NOTE:

- If fixing to timber framed walls or partitioning the wall should be reinforced with noggin to receive fixing bolts.
- Back/Rear of basin is unglazed.

Counter

Note: Rear of basin is unglazed. Any counter top installation is recommended against the wall.

1. Cut out bench top as per template supplied (d).
2. Fit selected tapware and waste supplied to basin. Ensure waste is siliconed around rim.
3. Apply waterproof sealant to rim of basin.
4. Locate basin complete with fittings onto bench top and press firmly all around.
5. Remove excess sealant.
6. External edges can be joint sealed using flexible sealant ensuring to wipe off any excess.

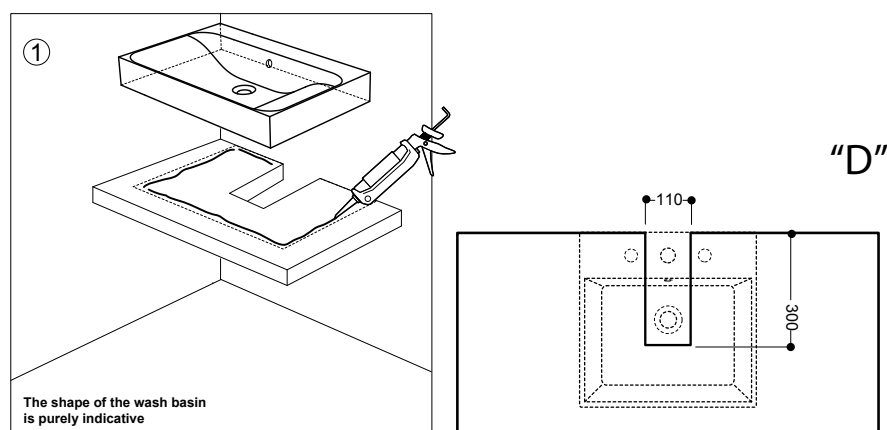

Plumbers, please ensure a copy of the installation instructions is left with the end user for future reference



REECE PRODUCT QUALITY GUARANTEE

You have purchased a quality product from Reece Pty Ltd ABN 84 004 097 090 ("Reece"). This product is covered by a 15 year replacement product warranty and a 12 month warranty over spare parts and labour.

15 YEAR WARRANTY – DOMESTIC USE

This warranty covers faults in the product construction, material and assembly. Products which are within 15 years from the date of purchase, found upon inspection by an authorised Reece representative, to be defective in construction, material or assembly, will be repaired or exchanged with an equivalent product free of charge. Replaced items become Reece's property.

All replacement products will be available for collection without charge to the customer at the nearest Reece branch to the customer's location, or elsewhere as agreed between the customer and Reece.

Labour and Spare Parts

The labour for the replacement of products and spare parts to which this warranty applies will be supplied by Reece or relevant supplier using licensed plumbers engaged by Reece or relevant supplier within 1 year from the date of purchase.

Spare parts which are within 1 year from the date of purchase found upon inspection by an authorised Reece representative to be defective in construction, material or assembly, will be replaced free of charge.

Warranty Conditions

This warranty will apply only under all of the following conditions:

- The item has been installed by a licensed plumber
- The item has been installed for and subjected to domestic residential use only
- Failure is due to a fault in the manufacture of the product
- Proof of purchase (including the date of purchase) is provided
- The installation of the product is in accordance with the instructions provided

This warranty does not cover products purchased as an ex-display without being fully checked and tested for sale by the manufacturer.

This warranty does not include faults caused by:

- Unsuitable or improper use
- Incorrect installation or installation not in accordance with the instructions provided
- Installation or part installation by the purchaser or any person other than a LICENSED PLUMBER
- Normal wear and tear
- Inadequate or complete lack of maintenance
- Chemical, electrochemical or electrical influences
- Harsh detergents or abrasive cleaners used on product finishes

1 YEAR WARRANTY – COMMERCIAL USE

'Commercial' use is all use other than for normal domestic residential purposes, including use in non-business places as in public buildings, schools, sports centres and in establishments that contain private bathrooms with high frequency of use by many individuals, such as hotels, motels, retirement villages and hospitals.

The Commercial warranty covers this product against manufacturing faults in the construction, material and assembly of both the finished products and any spare parts for a period of 1 year from the date of purchase. Products and spare parts which are found upon inspection by an authorised Reece representative to be defective in construction, material or assembly will be repaired or exchanged free of charge. Replaced items become Reece's property. The labour for the replacement of products and spare parts to which this warranty applies will be supplied by Reece or relevant supplier using licensed plumbers engaged by Reece or relevant supplier. The Warranty Conditions and exclusions which apply to the domestic use warranty also apply to this commercial warranty.

EXCLUSIONS

To the fullest extent permitted by law, Reece excludes all liability for damage or injury to any person, damage to any property, and any indirect consequential or other loss or damage.

CLAIM PROCEDURE

For all warranty queries customers are to contact the branch where the product was purchased. These details can be found on your purchase invoice.

Our goods come with guarantees that cannot be excluded under the Australian Consumer Law. You are entitled to a replacement or refund for a major failure and for compensation for any other reasonably foreseeable loss or damage. You are also entitled to have the goods repaired or replaced if the goods fail to be of acceptable quality and the failure does not amount to a major failure.