

LAUFEN

LAUFEN Val Wall/Counter Basin with Overflow 1 Taphole 530 x 400mm Internal Texture White

9510146

SPECIFICATIONS

Recommended Use	Residential;Commercial
Primary Material	SaphirKeramik
Colour Finish	White
Bowl Capacity (L)	3.6
Weight (kg)	9.7
Taphole Configuration	One
Overflow Included	Yes
Plug & Waste Included	No



WARRANTY

Residential & Commercial Use (Years)	25
Spare Parts & Labour (Years)	1

Please refer to LAUFEN Warranty page for full Terms and Conditions

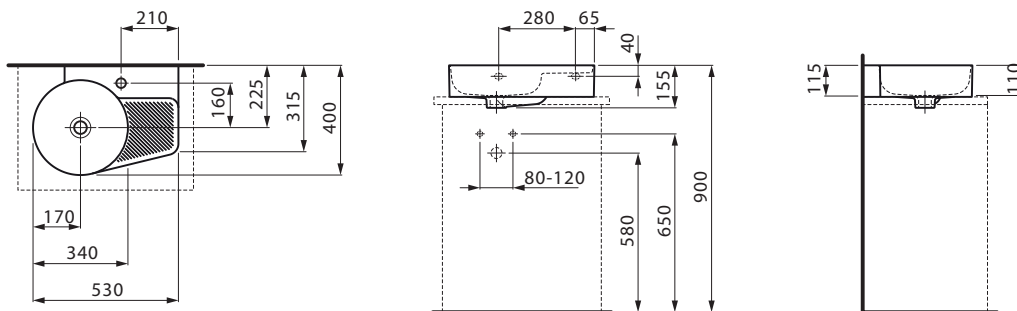

Dimensions are nominal measurements only.

CLEANING RECOMMENDATIONS:

We recommend the use of soapy water or approved cleaners. This product should not be cleaned with abrasive materials. Damage caused by any improper treatment is not covered by the product warranty. Refer to Warranty Conditions

Disclaimer: Products in this specification manual must by regulation be installed by licensed and registered trade people. The manufacturer/distributor reserves the right to vary specifications or delete models from their range without prior notification. Dimensions are nominal measurements only. Dimensions and set-outs listed are correct at time of publication however the manufacturer/distributor takes no responsibility for printing errors.

Published 23/04/2026

To see the complete LAUFEN range go to
www.reece.com.au

