

Billi®

Commercial User Guide

Billi Eco (901000)

Dispenser options:

XL, XT, XR, MMT, XT Motion



CONTENTS

Warnings and Important Information	3
Warnings and Important Information	4
General Maintenance	4
Dispenser Care	4
Cupboard Ventilation Requirements	4
Features	5
Safety Timeout	5
Childproof safety switch	5
Self learning timer (Eco-Intelligence)	5
Standby Mode	5
Boiling water disabled mode	5
Dispenser Features	6
XL Dispenser	6
XT, XR Dispenser	6
Multifunction Mixer Tap	6
XT Motion Dispenser	6
User Guide Eco - XL	7
Options and Operation	7
Safety Switch settings	7
Power save mode settings (Eco-Intelligence, standby or on 24/7)	7
User Guide Billi Eco - XT, XR	8
Options and Operation	8
Safety Switch settings	8
Power save mode settings (Eco-Intelligence, standby or on 24/7)	8
Holiday mode	8
User Guide Billi Eco - MMT	9
Options and Operation	9
Energy Savings	9
User guide. Billi Eco - XT Motion	10
Options and Operation	10
Dispenser Features - Billi Eco - XL	11
Dispenser Features - Billi Eco - XT	12
Dispenser Features - Billi Eco - XR	13
Multifunction Mixer Tap Icons	14
XT Motion Dispenser Icons	14
XT Motion Operating Instructions (Touchless)	15
Billi Filter Cartridges	16
Replacement of Billi Filter Cartridge	16
Filter Change Due Monitor	16
Filter removal and replacement instructions	16
Billi Filter Removal. Contd.	17
Billi Eco	18

Warnings and Important Information

- For continued safety of this appliance, it must be installed, operated, and maintained in accordance with the manufacturer's instructions.
- Your appliance should be installed by the manufacturer, a service agent, or any other suitably qualified tradesperson.
- For correct operation of this appliance, it is essential to observe the instructions as outlined in this booklet.
- Do not use this appliance with water that is microbiologically unsafe or with water of unknown quality without adequate disinfection before or after the system. Systems certified for cyst reduction may be used on disinfected water that may contain filterable cysts.
- Filter replacement must be performed at intervals of not more than 12 months.
- Use this appliance only as directed in these instructions and only for its designed purpose.
- This appliance is not intended for use by persons (including children) with reduced physical, sensory or mental capabilities, or persons with lack of experience and knowledge, unless they are supervised or have been given instruction concerning use by a person responsible for their safety.
- This appliance is not to be installed in an area where a water jet could be used.
- Children should be supervised to ensure that they do not play with the appliance.
- **DANGER:** The operation of the thermal cut-out indicates a possibly dangerous situation. Do not reset the thermal cut-out until the water heater has been serviced by a suitably qualified person.
- **WARNING:** Do not connect any restrictor or pressure relief device to the vent pipe of this water heater if installed.
- If the supply cord is damaged, it must be replaced by the manufacturer, its service agent or similarly qualified persons in order to avoid creation of a hazard.
- **WARNING:** When positioning the appliance ensure the power supply cord is not trapped or damaged.
- **WARNING:** Avoid spillages of any kind on all electrical connectors.
- **WARNING:** Potential injury can result from misuse.
- **WARNING:** Heating element surface is subject to residual heat after use.
- Billi hose sets as supplied with the appliance are to be used. Old or other manufacturers' hose sets should not be re-used.
- **WARNING:** This appliance may deliver water at high temperature. Refer to the plumbing code of Australia (PCA), local requirements and installation instructions to determine if additional temperature control is required.
- **WARNING:** Installation shall conform to the plumbing code of Australia (PCA) or relevant local requirements.
- If the appliance is located where the ambient air temperature could fall below 4°C when the heater is not in use, do not turn off the power supply to the appliance. This safeguard does not offer the same protection to the connecting pipework and fittings.
- The ambient temperatures this unit should operate within are 4°C to 45°C.
- Turn off power to unit, by unplugging the power cord from the power point, if water supply is turned off.
 - The appliance is intended to be used in household and similar applications such as:
 - Staff kitchen areas in shops, offices and other working environments
 - Farmhouses and by clients in hotels, motels and other residential type environments
 - Bed and breakfast type environments
 - Catering and similar non-retail applications
- **WARNING:** When positioning the appliance, ensure the supply cord is not trapped or damaged.
- **WARNING:** Do not locate multiple portable socket - outlets or portable power supplies at the rear of the appliance.

Please note maximum water inlet pressure is 1000K Pa

Warnings and Important Information

Boiling water is dangerous and can cause severe burns, particularly with young children. Boiling water must always be handled with caution. Use this appliance only as directed in these instructions and only for the purpose for which it has been designed.

Your Billi Eco is designed to be safe and practical. In an environment with young children, it is recommended that the boiling water safety switch is activated.

In addition, the following safety features have also been included:

- Ergonomic levers.
- Levers/touch activations located safely away from water outlets.
- Smooth electronically controlled boiling water flow rate. Flow is briefly reduced as water first enters the cup to prevent splashing.
- Dispenser remains cool to touch.
- Childproof safety switch.
- Boiling water Safety Isolation mode.

General Maintenance

Your Billi Eco has been designed to require minimal maintenance other than replacement of filter cartridges.

During each filter change, check all water connection and fittings for signs of leakage, all tubing for any signs of damage and in the cupboard area around the base of unit for any signs of moisture.

Ensure side vents of the underbench module are kept clear and airflow is not obstructed. Restricted airflow will cause inefficient operation of the refrigeration system.

Dispenser Care

Proper care of Billi electronic dispensers is crucial to prevent premature wear of surface finishes and to ensure reliable dispense operation.

Avoid using abrasive cleaners on any external surfaces of the dispenser. Wipe clean only using damp cloth. Use of a nonsolvent, non-smearing cleaner such as Windex is recommended. DO NOT pour water directly over the dispenser.

Cupboard Ventilation Requirements

Your Billi Eco underbench module requires minimal cupboard ventilation and requires air space around the unit of 100mm. Care should be taken when using the cupboard space, to avoid stretching or damaging plastic pipework. Check fittings and tubing at each filter change for signs of damage or leakage. Always ensure access to power switch and water supply tap is not restricted.

Features

Safety Timeout

Your Billi Eco incorporates a water delivery Safety Timeout to prevent an uncontrolled flow of water. Water flow stops automatically after a set time interval. Flow can be started again by releasing and pressing the dispenser lever or buttons. Boiling water timeout – 10 secs; Chilled water – 30 secs.

Childproof safety switch

Your Billi Eco is fitted with a childproof safety lock-out feature to protect against accidental dispensing of boiling water and the risk of burns. Please refer to safety switch settings on page 5.

Self learning timer (Eco-Intelligence)

Your Billi Eco incorporates an energy-saving self-learning timer. This timer learns the user's behaviour over a period (up to one month) and pre-empts the need for water throughout each 24-hour period over a week. Data is lost when the power is removed, however learnings from the first day's use is applied to the entire learning cycle so the unit will quickly resume intelligent timer operation. When the self-learning timer is enabled, the unit will enter standby if no water is expected to be used for a 3 hour or more period. The unit will shut down completely if no water is expected to be used for a 6 hour or more period. In office environments this feature will typically cause the unit to turn off outside normal business hours, i.e.: overnight and on weekends. In domestic environments with no one home during working hours the unit will turn off through each weekday but may remain on at night and during weekends. See page 6 for dispenser icons. To activate, refer to Options, page 5.

Standby Mode

Standby operation may be optionally enabled to reduce power consumption. In standby mode, the hot water set point is reduced to 72°C and the cold water set point is increased to 18°C. When enabled, standby is invoked after two hours from the time of last use. When a tap lever or button is pressed in standby, no water is dispensed. The indicators will flash to indicate the water is not ready. The lever or button can be repressed to dispense water. During Standby mode, the moon & star icon will be illuminated. To activate, refer to Options, page 5.

Boiling water disabled mode

Your Eco Sparkling features an additional boiling water safety isolation feature. Once activated, delivery of boiling water becomes totally disabled. Chilled water can be dispensed normally. During this mode, the red, hot, icon will remain off. To activate, refer to Options & Operation Safety Switch Settings, page 5.

Dispenser Features

XL Dispenser

The XL dispenser is simply operated with position-sensitive levers.

The red dot on the left indicates the boiling water lever and the blue dot on the right indicates the chilled water lever. Simultaneously use both levers to dispense sparkling water.

Both levers can either be lifted or depressed. When lifted, the levers will latch for continuous delivery until released with a light press.

The XL dispenser incorporates a swivel function, allowing the dispenser to be swung 45 ° in either direction if more sink space is required.

A central position stop provides position location during usage. To enable the swivel feature, the locking piece needs to be removed as per the dispenser installation instructions.

XT, XR Dispenser

The XT and XR dispenser are operated with capacitive touch buttons. Red and blue buttons indicate the boiling and chilled water.

Red and blue buttons can be pressed and held for momentary dispensing or double tapped for continuous flow. Water will not flow if both buttons are held together.

Multifunction Mixer Tap

The Multifunction mixer tap incorporates both filtered and mains mixer water functionality in one tap.

Filtered water dispense is operated with capacitive touch buttons on the left side of the tap. Red, blue, and white buttons indicate boiling, chilled, and sparkling water dispense.

Buttons can be pressed and held for momentary dispensing or double tapped for continuous delivery until stopped by pressing either of the boiling, chilled or sparkling buttons.

Mains mixer water is operated using the mixer lever on the right side of the tap.

XT Motion Dispenser

The XT Motion dispenser delivers boiling, and chilled filtered water through an integrated dual-control interface that supports both touch and touch-free activation. The system allows users to dispense water with precision and safety using motion control, while enhancing hygiene and usability in high-use environments.

Filtered water dispense is operated with capacitive touch buttons on the top of the tap. Red, and blue buttons indicate boiling, and chilled water dispense.

Buttons can be pressed and held for momentary dispensing or activated by touch-free motion. Double tap the corresponding buttons to dispense water continuously

Options and Operation

To operate, simply press the left lever to dispense boiling water and the right lever to dispense cold. When lifted, the levers will latch for continual delivery, until released with a light press. Operating modes can be selected by the user by entering Options Mode. Within the options mode, you can set the safety switch through the hot water lever and power save mode through the cold-water lever. See below for further instructions.

To enter the options mode:

1. Turn on the unit and wait for normal operation (red & blue icons are both illuminated constantly).
2. Press both the hot and cold levers on the dispenser. While holding the two levers down, touch the safety switch indent at the back of the dispenser. Hold both levers and the safety switch until dispenser lights change colour.
3. Release both the levers and safety switch.
4. Within 10 seconds, push and release the pressure relief button on the unit.
5. Unit is now in options mode.
6. If you wish to change or set the safety switch mode, follow the safety switch settings procedure. If you wish to change or activate the power saving mode, follow the power save mode settings procedure.

Safety Switch settings

The **Red** padlock indicates the different safety settings enabled. To change or activate a setting once in options mode, press and release the hot (left) lever to scroll through the following options:

- **Red Icon Off:** indicates the hot tap is disabled.
- **Padlock icon on, Red icon on:** indicates safety switch is enabled
- **Red Icon On:** indicates normal operation with safety switch not enabled.

To save new settings and exit Options Mode, touch the safety switch and release. Wait 10 seconds for unit to return to normal operation, with the desired settings. To dispense boiling water once the safety switch is activated, simply touch the indent on the black panel, at the back of the tap. You will be able to dispense boiling water for 8 seconds. After 8 seconds, the safety switch will automatically reactivate, and the red padlock icon will appear again.

Power save mode settings (Eco-Intelligence, standby or on 24/7)

The **Green** icons on the tap indicate the power save level that is selected. To change or activate a setting once in options mode press and release the cold(right) lever to scroll through the following options:

- **Green Leaf icon:** indicates Eco Intelligence™ self-learning timer is enabled.
- **Moon & Star Icon on:** indicates Standby Mode is enabled.
- **Blue Icon On, no green icons:** indicates system is in 24-hour continuous mode

To save new setting and exit Options Mode, press the safety switch and release. Wait 10 seconds for unit to return to normal operation, with the desired settings.

Holiday mode

To set press the pressure relief valve located under the unit cover beside the filter housing.

Options and Operation

To operate, simply press the red (left) button to dispense boiling water, and blue (right) button ring to dispense cold filtered water. When the red or blue buttons are double tapped, the water will dispense continually until interrupted by another light press of either button. Operating modes can be selected by the user by entering option mode. Within the options mode, you can set the safety switch through the hot red button (left) and power save mode through the blue button (right).

To enter the options mode:

1. Turn on the unit and wait for normal operation (red & blue icons are both illuminated constantly).
2. Press both the hot and cold levers on the dispenser. While holding the two levers down, touch the safety switch indent at the back of the dispenser. Hold both levers and the safety switch until the dispenser lights change colour.
3. Release both the levers and safety switch.
4. Within 10 seconds, push and release the pressure relief button on the unit.
Note: Older models may require this step to be skipped.
5. Unit is now in options mode.
6. If you wish to change or set the safety switch mode, follow the safety switch settings procedure. If you wish to change or activate the power saving mode follow the power save mode settings procedure.

Safety Switch settings

The Red padlock indicates the different safety settings enabled. To change or activate a setting once in options mode, press and release the hot (left) lever to scroll through the following options:

- **Red Icon Off:** indicates the hot tap is disabled.
- **Padlock icon on, Red icon on:** indicates safety switch is enabled
- **Red Icon On:** indicates normal operation with safety switch not enabled.

To save new setting and exit Options Mode, touch the safety switch and release. Wait 10 seconds for unit to return to normal operation, with the desired settings . To dispense boiling water once the safety switch is activated simply touch the red lock icon on the top of the lens. You will be able to dispense boiling water for 8 seconds. After 8 seconds the safety switch will automatically reactivate, and the red padlock icon will appear again.

Power save mode settings (Eco-Intelligence, standby or on 24/7)

The Green icons on the tap indicate the power save level that is selected. To change or activate a setting once in options mode press and release the cold(right) lever to scroll through the following options:

- Green Leaf icon: indicates Eco Intelligence™ self learning timer is enabled.
- Moon & Star Icon on: indicates Standby Mode is enabled.
- Blue Icon On, no green icons: indicates system is in 24 hour continuous mode

To save new setting and exit Options Mode, press the safety switch and release. Wait 10 seconds for unit to return to normal operation, with the new settings.

Holiday mode

To set press the pressure relief valve located under the unit cover beside the filter housing.

Options and Operation

To operate, simply press the red button to dispense boiling water, and blue button ring to dispense cold filtered water. When the red or blue buttons are double tapped, the water will dispense continually until interrupted by another light press of either button. Operating modes can be selected by the user by entering option mode. If the safety switch feature is activated, you must first press the unlock button before pressing the red button to dispense boiling water.

The safety switch feature can be activated or deactivated in the options mode.

To enter the options mode:

1. Press and hold the space directly between the lock button and the cold button, while simultaneously holding the lock button. Hold for 3 seconds and release; the red and blue buttons flash while orange light appears in the space directly between the lock button and the cold button; you can now release.
2. Press the pressure release button once on the front of the underbench module. (Orange light steady, hot and cold buttons become aqua).
3. Tap icons should change colours and orange light will appear in the space between the lock and cold button.
4. Press and hold the boiling button until the orange light changes to white then release. (cold button turns green, red is red). No light is shown in the space between the lock and the cold button.
5. Unit is now in hot settings mode, to scroll through the following settings:
 - a. Press the boiling button once for hot safety-off option (Always unlocked).
 - b. Press the boiling button twice for hot safety-on option (lock enabled).
 - c. Press the boiling button thrice to disable the hot option completely (red LED switches off).

Press the safety button to confirm the selection.

Energy Savings

1. Press and hold the sparkling button, between the lock button and the cold button, while simultaneously holding the lock button. Hold for 3 seconds and release; the red and blue buttons flash while orange light appears between the lock button and the cold button; you can now release.
2. Press the pressure release button once on the front of the underbench module.
3. Tap icons should change colours and orange light will appear on the sparkling button.
4. Press and hold the cold button until the green light turns white, then release.
5. Now you are in energy settings mode, to scroll through the following settings:
 - a. Press the cold button once for 24-hour continuous mode (Green light on).
 - b. Press the cold button twice for Eco Intelligence™ mode (No light on cold button).
 - c. Press the cold button thrice for holiday mode (No light on cold button).

Press the safety button to confirm the selection.

Options and Operation

To operate, simply press the red (left) button to dispense boiling water, and blue (right) button ring to dispense cold water. Alternatively, position your hand at the rear of the tap body (same gesture as an XL safety lock). The Safety Padlock indicator will change from locked to unlocked. Now hold your hand over the top of the boiling icon on the UI panel to begin dispensing boiling water.

For chilled water, place your hand on the right side of the tap body. Maintain your hand position to dispense chilled water.

Note: Boiling water can only be dispensed when the Boiling Water Safety Lock is disengaged. If the safety lock is disengaged using the tactile method, boiling water can only be dispensed using the tactile method. If the safety lock is disengaged using the touchless method, boiling water can be dispensed using the tactile or touchless method

To enter the options mode:

Note: Please wait at least 30 seconds for calibration prior to configuration mode.

1. Press the cold button for 10s, then immediately press the Boiling Water Safety lock button.
2. Boiling Water lock button should start flashing blue, this means we are now in setup mode, press the cold button to continue.
3. Boiling Water lock button will flash for each mode, press the cold button to cycle through the modes
 - i. Flash 1 time, tap is in BCS mode
 - ii. Flash 2 times, tap is in BC mode
 - iii. Flash 3 times, for CA mode
4. Press the Boiling Water Lock Button to apply.
5. Boiling Water Lock Button will now flash pink
6. Press the cold button to cycle through the modes, to Enable (or disable) contactless mode
 - i. Flash 1-time, contactless mode enabled
 - ii. Flash 2 times, contactless mode disabled
7. Press the Boiling Water Lock Button to apply the setting and reboot the tap.

Dispenser Features - Billi Eco - XL



Dispenser Icon

Orange dot.

Flashes when filter change is due. On constant when overdue.

Red lock illuminated.

Safety button is activated. To use, press the indent on the back of the tap momentarily & lift or press the boiling lever.

Green leaf illuminated.

Eco intelligence.

Green moon & stars illuminated.

In holiday mode. Red & blue icons will not be displayed in this mode.

Green moon & stars flashing

In standby mode. Red & blue icons will not be displayed in this mode.

Red dot.

Flashes when heating up to temperature. On constant when boiling water is ready, Off when in holiday or standby mode.

Blue dot.

Flashes when chilling. On constant when chilled water ready. Off when in holiday or standby mode. Red & blue dots will flash yellow if the unit goes into fault.

Dispenser Icon codes



Red

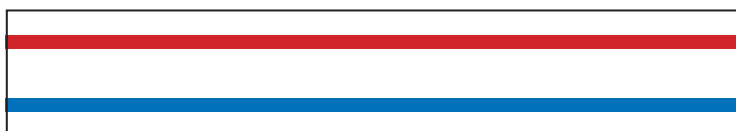

Normal operation



Blue

Normal operation



Red

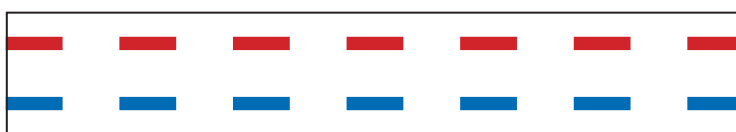

Operating temperatures of hot and cold water not yet reached



Red



Boiling water disabled



Red

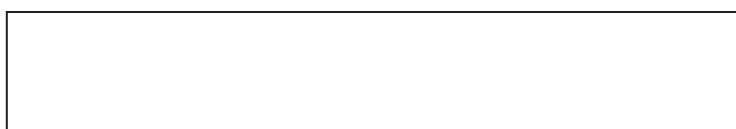

System in holiday or standby mode or off



Orange



Unit in fault mode



Orange

Dispenser Features – Billi Eco – XT



Dispenser Icon

Orange dot.

Flashes when filter change due. On constant when overdue.

Red lock illuminated.

Safety button activated. To use, press the indent on the top of the tap momentarily & lift or press the red button.

Green leaf illuminated.

Eco intelligence.

Green moon & stars illuminated.

In holiday mode. Red & blue icons will not be displayed in this mode.

Green moon & stars flashing

In standby mode. Red & blue icons will not be displayed in this mode.

Red ring.









Flashes when heating up to temperature. On constant when boiling water is ready, Off when in holiday or standby mode.

Blue ring.

Flashes when chilling. On constant when chilled water ready. Off when in holiday or standby mode.

Red & blue rings will flash yellow if the unit goes into fault.

Dispenser Icon codes

	Red		Normal operation
	Blue		Normal operation
	Red		Operating temperatures of hot and cold water not yet reached
	Blue		
	Red		Boiling water disabled
	Blue		
	Red		System in holiday or standby mode or off
	Blue		
	Orange		Unit in fault mode
	Orange		

Dispenser Features – Billi Eco – XR



Dispenser Icon

Orange dot.

Flashes when filter change due. On constant when overdue.

Red lock illuminated.

Safety button activated. To use, press the indent on the top of the tap momentarily & lift or press the red button.

Green leaf illuminated.

Eco intelligence.

Green moon & stars illuminated.

In holiday mode. Red & blue icons will not be displayed in this mode.

Green moon & stars flashing

In standby mode. Red & blue icons will not be displayed in this mode.

Red ring.





















Flashes when heating up to temperature. On constant when boiling water is ready, Off when in holiday or standby mode.

Blue ring.

Flashes when chilling. On constant when chilled water ready. Off when in holiday or standby mode.

Red & blue rings will flash yellow if the unit goes into fault.

Dispenser Icon codes

	Red		Normal operation
	Blue		Normal operation
	Red		Operating temperatures of hot and cold water not yet reached
	Blue		
	Red		Boiling water disabled
	Blue		
	Red		System in holiday or standby mode or off
	Blue		
	Orange		Unit in fault mode
	Orange		

Multifunction Mixer Tap Icons



Red Lock Illuminated

Childproof Safety Lock is on. To unlock press the red lock icon. Lock turns green when unlocked.

Orange Ring Icon

Appears & flashes when filter change is due. On constant when overdue.

Blue Chilled Icon

Flashes when chilling. On constant when chilled water is ready. Switches off when energy saving mode is activated by either the standby feature or the time switch feature. Flashes yellow when unit goes into fault.

Red Boiling Icon

Flashes when heating up to temperature. Will flash faster when approaching temperature setpoint. On constant when boiling water is ready. Switches off when energy saving mode is activated by either the standby feature or the time switch feature. Flashes yellow when unit goes into fault.

XT Motion Dispenser Icons



Red Lock Illuminated

Childproof Safety Lock is on. To unlock press the red lock icon. Lock turns green when unlocked.

Orange Ring Icon

Appears & flashes when filter change is due. On constant when overdue.

Blue Chilled Icon

Flashes when chilling. On constant when chilled water is ready. Switches off when energy saving mode is activated by either the standby feature or the time switch feature. Flashes yellow when unit goes into fault.

Red Boiling Icon

Flashes when heating up to temperature. Will flash faster when approaching temperature setpoint. On constant when boiling water is ready. Switches off when energy saving mode is activated by either the standby feature or the time switch feature. Flashes yellow when unit goes into fault.

XT Motion Operating Instructions (Touchless)

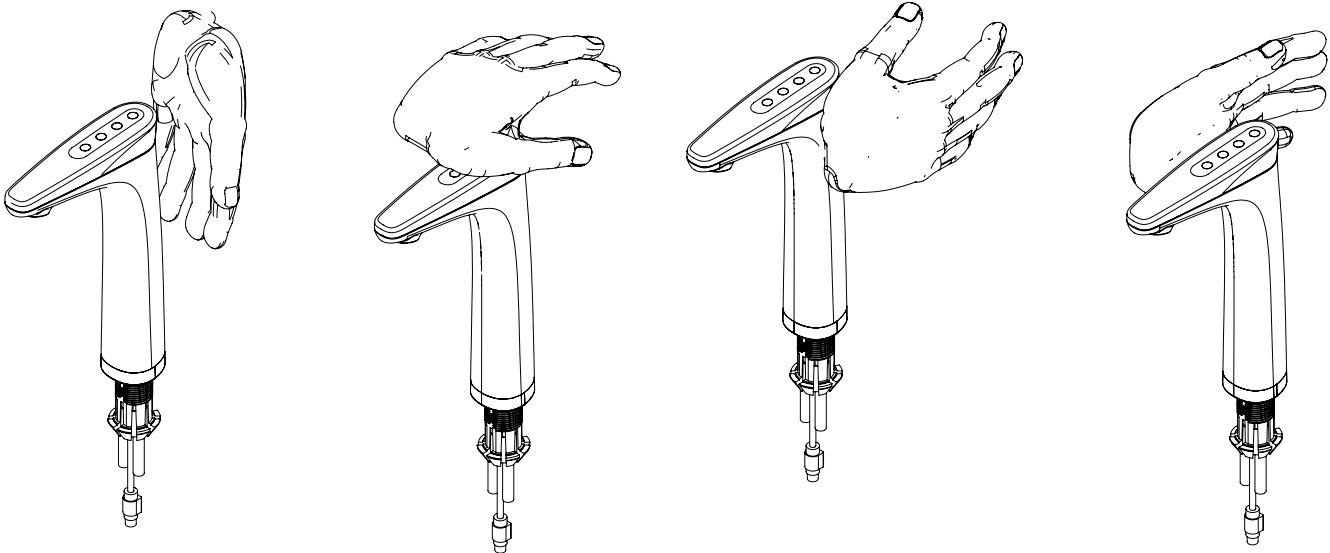

Boiling Water - Touchless

1. Position your hand at the **rear of the tap body** (same gesture as an XL safety lock).
2. The **Safety Padlock** indicator will change from locked → unlocked.
3. Now hold your hand over the top of the boiling icon on the UI panel to begin dispensing.

Sparkling Water - Touchless

1. Place your hand on the **left side** of the tap body.
2. Maintain your hand position to continue dispensing sparkling water.

Chilled Water - Touchless

1. Place your hand on the right side of the tap body.
2. Maintain your hand position to dispense chilled water.

Note: Boiling water can only be dispensed when the Boiling Water Safety Lock is disengaged.

- If the safety lock is disengaged using the tactile method, boiling water can only be dispensed using the tactile method.
- If the safety lock is disengaged using the touchless method, boiling water can be dispensed using tactile or touchless method.

Billi Filter Cartridges

All Billi Eco models feature the Billi swing-change filtration system, allowing for quick and easy filter change. The Eco is fitted with a single carbon filter that utilises BWT's unique Fibron X® technology. This technology features a graded density profile, ensuring maximum performance and capacity, and provides superior drinking water quality, consistent filter life and peace of mind.

Use only Billi genuine filters designed for this system. All drinking water systems should be flushed after a period of non-use.

Replacement of Billi Filter Cartridge

Periodic replacement of your Billi Eco's filter cartridge is necessary to maintain the cleanliness and purity of your drinking water. A replacement filter change service is available. To arrange, contact the Billi Service centre on **1800 812 321**. If you wish to install the replacement filter cartridges yourself, filters can be purchased online at www.billi.com.au or through a certified agent which will provide genuine Billi replacement filter cartridge sets.

Filter Change Due Monitor

The Eco filter change due monitor operates by counting the number of cups dispensed and the number of days elapsed until a pre-set level is reached. Once reached, the yellow filter icon as pictured above will turn on. The Eco will continue to operate while the filter indicator is flashing. Water filters installed in areas with higher levels of sediment will experience a reduced service life. It may be necessary to change filters before the change filter indicator flashes. If particularly dirty water is noticed coming through the water supply, e.g. from other tap ware, immediately place your Billi Eco into Holiday Mode by pressing the Pressure Relief button. This will help prevent premature blocking of the filter cartridges.

Filter removal and replacement instructions

Important note: Please ensure you remove the foam packing under the filter before installing.

1. Remove the front panel.
2. Place the unit in Holiday Mode by pressing the Pressure Relief button once. The lights on the dispenser will alternate and then go off
3. Hold filter and swing towards you slowly. The top of the filter is in a hinged cradle assembly. It should stop after approximately 30 degrees of travel.
4. The filter can now be released from the holding cradle by pulling down on the filter.
5. Take care not to spill water in the base of the tray. If so, wipe gently with absorbent paper.
6. Install new filter into the same location by pushing all the way up into the cradle.
7. Push filter back into the unit until it locks into place. Power light should come back on.
8. Flush chilled side until water flow stops. Wait 10 minutes. Repeat these steps 2 times.
9. Check for any leaks from around the filter, hosing or pipeworks.
10. Replace the front cover.

Billi Filter Removal. Contd.

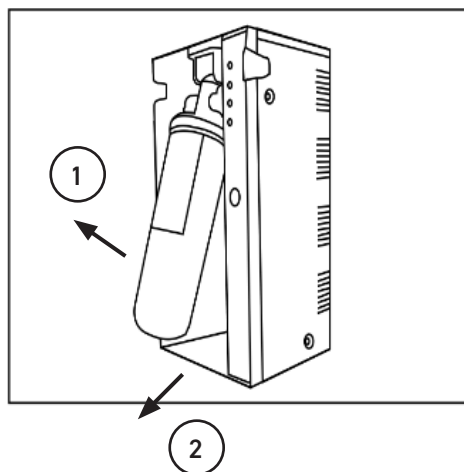
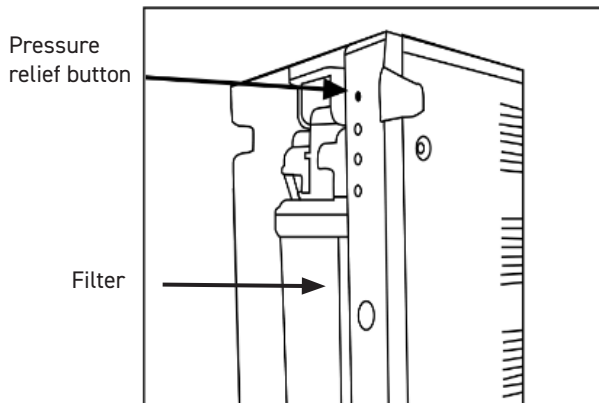
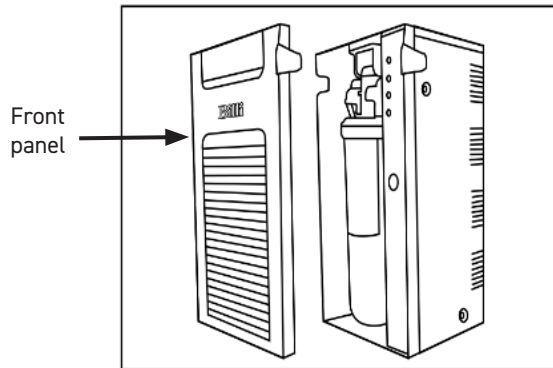

Billi Eco

Thank you for choosing to install a Billi Eco Drinking Water Appliance. Your Eco is manufactured to exacting standards using high quality materials and with proper maintenance and care, should function for many years.

For information on our filtration and service contract please contact:

Billi Head Office on **1800 812 321**

E-mail (Australia/NZ): service@billi.com.au.

Email (International sales): international.sales@billi.com.au

For technical support please call: **1800 812 321** and speak to one of Billi's experienced technicians.

Filter cartridges are also available for purchase online at www.billi.com.au



Please scan the QR code for all support information.

Billi Australia Pty Ltd

P 1800 812 321
W www.billi.com.au

Billi New Zealand Ltd

P 0800 636 0 636
W www.billi.co.nz

Billi®

Designed and manufactured in Australia.

Billi® is a registered trademark of Billi Australia Pty Ltd. © Copyright protected.

Billi Australia Pty Ltd has a policy of continual improvement, all details are subject to change without notice. All goods are sold subject to our published terms and conditions.

Billi[®]