

mizu

Mizu Drift MK2 750 x 800mm Heated Towel Rail Low Voltage 24V Brushed Stainless Steel

9511205

SPECIFICATIONS

Recommended Use	Residential;Commercial
Colour Finish	Brushed Stainless Steel
Primary Material	Stainless Steel 304
Mounting	Wall
Electrical Connection Type	Hardwired
Heating Method	Dry Element
Power Supply (V)	24V AC
IP Rating	IP45

WARRANTY

Residential & Commercial Use (Years)	10
Spare Parts & Labour (Years)	1

Please refer to Mizu Warranty page for full Terms and Conditions

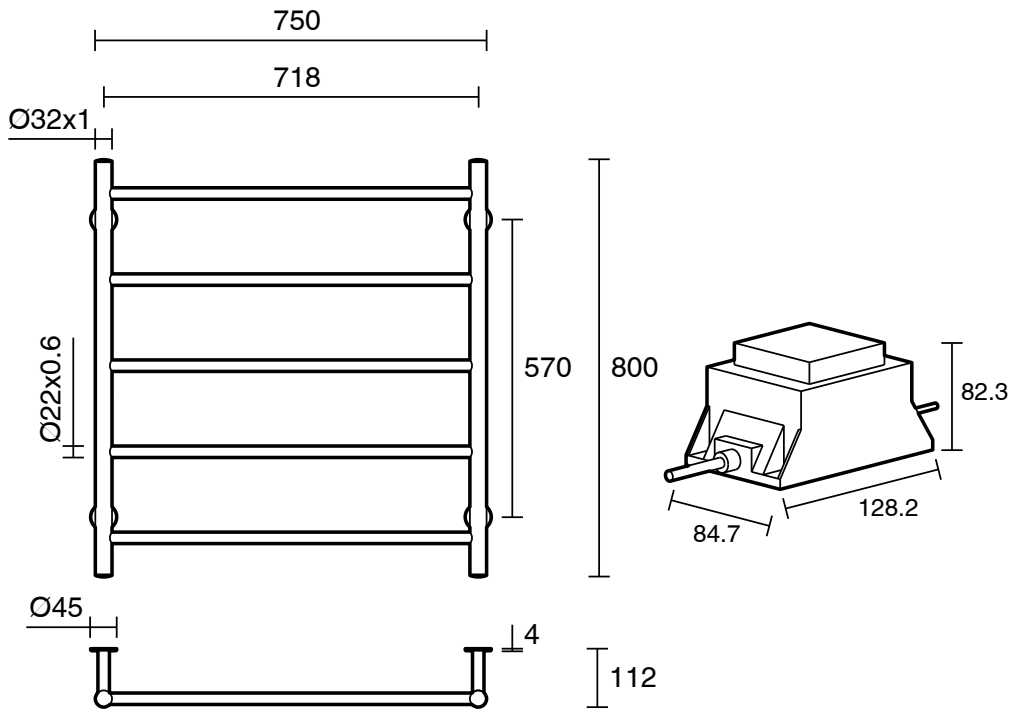

Dimensions are nominal measurements only.

CLEANING RECOMMENDATIONS:

We recommend the use of soapy water or approved cleaners. This product should not be cleaned with abrasive materials. Damage caused by any improper treatment is not covered by the product warranty. Refer to Warranty Conditions

Disclaimer: Products in this specification manual must by regulation be installed by licensed and registered trade people. The manufacturer/distributor reserves the right to vary specifications or delete models from their range without prior notification. Dimensions are nominal measurements only. Dimensions and set-outs listed are correct at time of publication however the manufacturer/distributor takes no responsibility for printing errors.

Published 01/04/2026

To see the complete Mizu range go to www.reece.com.au

